



Republic of Kenya

**THE NATIONAL**  
**BUILDING CODE**  
**2024**

**SPECIAL ISSUE**

Kenya Gazette Supplement No. 36

397

20th February, 2024

(Legislative Supplement No. 26)

LEGAL NOTICE NO. 47

THE NATIONAL CONSTRUCTION AUTHORITY ACT,

(Cap. 118)

THE NATIONAL BUILDING CODE, 2024

ARRANGEMENT OF PARAGRAPHS

*Paragraph*

PART I—PRELIMINARIES

1. Citation and commencement.
2. Interpretation.
3. Purpose of Code.
4. Scope of Code.
5. Compliance with applicable laws.
6. Supervision of construction works.

PART II—SITING AND SPACE ABOUT BUILDINGS

7. Compliance to basic physical planning requirements.
8. Siting of building.
9. Access to construction site.
10. Frontage.
11. Service area.
12. Means of an enclosure of building.
13. Obstruction of view.
14. Space around residential building.
15. Service lane.
16. New building on existing road.
17. Protection edge above ground floor.
18. Space in front of building.
19. Side space.
20. Measurement of courtyard.
21. Means of access.
22. External passage.

23. Eave, cornice or moulding.
24. A balcony or canopy over road.
25. No door on to canopy.
26. Use of veranda or balcony.
27. Door, window and gate not to open over road.
28. Tenement house.
29. Enclosure and storage for combustible material.
30. Enclosure for a timber yard.
31. Temporary building.
32. Maintenance of a hoarding, covered walkway or gantry.
33. Building not to obstruct, endanger or cause nuisance.
34. Light and ventilation not to be diminished.

#### PART III—PARKING SPACES

35. Parking requirements.
36. Vehicular circulation
37. Garage dimensions.
38. Charging port for electric vehicle.
39. Pedestrian guarding.
40. Design of guarding.
41. Vehicle barrier.
42. Vehicle ramp or driveway.
43. Pedestrian ramp.
44. Access ramp.
45. Maximum curved gradient.
46. Parking spaces.

#### PART IV—PREPARATION OF CONSTRUCTION SITES

47. Protection of construction site.
48. Damage to public facility or utility.
49. Unstable soil or slope.
50. Preparation of construction site.
51. Quality of soil.
52. Control of dust and noise.
53. Cutting into, laying open and demolishing construction works.
54. Waste material on construction site.

55. Cleaning of construction site.

56. Contractors' shed.

57. Facilities at construction site.

PART V—BUILDING MATERIALS

58. Building materials.

59. Used material.

PART VI—STRUCTURAL DESIGN

60. Structural design requirements.

61. Structural design.

62. Structural material.

63. Professional obligations in structural design.

64. Design for foundation.

65. Empirical rules for foundation.

66. General stability requirements for excavation.

67. Excavations for foundation.

68. Structural works supervision.

69. Welding.

70. Canopy.

71. Dead load.

72. Imposed load.

73. Reduction in total imposed load.

74. Imposed load on roof.

75. Imposed crane gantry girder.

76. Dynamic loading (excluding wind).

77. Vehicular bridge live load.

78. Parapet and balustrade.

79. Action on structure exposed to fire.

80. Thermal action.

81. Wind load.

82. Earthquake load.

83. Eccentric load of the foundation.

84. Cantilever resistance to overturning.

85. Foundations generally.

86. Strip foundation for single storey building.

**PART VII—SPACES WITHIN BUILDINGS**

87. Space requirements for room or space within a building.
88. Plan dimensions.
89. Room height.
90. Floor area of multipurpose room.
91. Protection of balcony or veranda.
92. Protection of opening.
93. Height of storey.
94. Landing, lobby or passage.
95. Distance from staircase.
96. Swimming pool.

**PART VIII—FLOORS**

97. Requirements for floor.
98. Floor constructed on black cotton soil.
99. Construction of floor.
100. Timber floor.

**PART IX—WALLS**

101. Structural strength and stability.
102. Roof fixing.
103. Fire resistance.
104. Empirical regulation for a wall.
105. Wall dimensions and opening.
106. External masonry cladding or infilling panel in framed buildings.
107. Column and pier in wall.
108. Cavity wall.
109. Foundation wall.
110. Building abutting retaining wall.
111. Retaining wall forming part of building.
112. Balustrade wall.
113. Free-standing wall.
114. Retaining wall of masonry.
115. Roof anchoring.
116. Water penetration.

117. Rain penetration test for wall.
118. Damp-proof course.
119. External wall weather resistance.
120. Protection against moisture from the ground.
121. Prevention of dampness in cavity wall.
122. Non-load-bearing wall.
123. Rendering.
124. Hollow block not to be used in foundation wall or chimney.
125. Sealing of cavity in wall.
126. Mortar.
127. Chase.
128. External walls in residential building.
129. Party or separating wall.
130. Boundary wall.
131. Coping to parapet wall.
132. Painting of wall.

#### PART X—LIGHTING AND VENTILATION

133. Lighting and ventilation of room.
134. Window and vent to face or ventilate into open air.
135. Artificial ventilation system.
136. Natural lighting.
137. Zone of space for natural lighting.
138. Natural ventilation.
139. Natural lighting and ventilation of room opening onto an enclosed balcony, gallery, veranda or court.
140. Artificial lighting.
141. Artificial ventilation.
142. Window.
143. Area of window.
144. Space opposite window.
145. Back-to-back dwellings.
146. Ventilation of habitable room.
147. Ventilation of pantry.
148. Ventilation and lighting of staircase or passage.

149. Ventilation of shop.
150. Garage connected to dwelling.
151. Ventilation and lighting of building of the warehouse class.
152. Lighting and ventilation for public building.
153. Design, construction and installation of space heating.
154. Chimney.
155. Hearth or fireplace for solid fuel appliance.
156. Ventilation design for space designated for specialised activity.
157. Mechanical ventilation and air-conditioning plant.
158. Ventilation of roof space.
159. Allowable mid frequencies reverberation time.
160. Energy efficiency and thermal comfort.
161. Sustainable building design strategy.
162. Renewable energy source.
163. Indoor air quality.
164. Lighting and ventilation.
165. Lighting and ventilation for habitation, office or kitchen.
166. Minimum requirements for window.
167. Distance of wall of a room from window.
168. Windows opening on to enclosed veranda.
169. Mechanical ventilation and artificial lighting of an office.
170. Additional ventilation.
171. Room containing soil water or waste fitment.

#### PART XI—GLAZING AND CLADDING

172. Type and fixing of glazing.
173. Installation of glazing.
174. Safety glazing.
175. Location for safety glazing.
176. Safe breakage of glass.
177. Robustness of glass.
178. Glazing in small pane.
179. Permanent screen protection.
180. Permanent manifestation.

181. Alternative indication of glazing.
182. Adjustable glass louvre blade.
183. Architectural glazing or cladding.
184. Thermal safety check.
185. Gasket sealing.
186. Cleaning system of curtain walling.
187. Glazed curtain walling.
188. Glazing system.
189. Sound insulation glazing.
190. Glazing thickness.
191. Climatic consideration.
192. Stone cutting wall cladding.
193. Fire performance of cladding systems.

#### PART XII—STAIRCASES, LIFTS AND ESCALATORS

194. Provision for staircase.
195. Staircase in buildings intended for separate occupation.
196. Staircase constructed in addition to escalator.
197. Step or landing of an escalator.
198. Means of escape.
199. Access staircase for firefighter.
200. Load and dimensions of staircase.
201. Pedestrian entrance to parking space in a building.
202. Compliance with fire safety requirement.
203. Dimensional requirement for staircase.
204. Protection for users of staircase.
205. Steepness of riser and tread.
206. Headroom on staircase.
207. Width of flight of staircase.
208. Length of flight of staircase.
209. Landing on staircase.
210. Staircase with tapered treads.
211. Fixed ladder.
212. Handrail for a staircase.
213. Enclosure and position of lift and motor room.



214. Compliance with No. 15 of 2007.
215. Provision of a lift.
216. Installation and operation of a lift.
217. Provision of an escalator.
218. Dimensions for lift installation.
219. Lift well enclosure.
220. Lift well inspection, emergency door and inspection trap.
221. Ventilation of lift well.
222. Wall, floor or ceiling of lift well.
223. Construction of the wall of lift well facing car entrance.
224. Protection of space located below car or counterweight.
225. Well containing car and counterweight belonging to several lifts or service lifts.
226. Lift well.
227. Machine or pulley room.
228. Access to machine or pulley room.
229. Structural strength and floor surface of machine or pulley room.
230. Dimensions of machine or pulley room.
231. Door or trap door to machine or pulley room.
232. Other opening in machine or pulley room.
233. Handling of equipment in machine room.
234. Machine room enclosure.
235. A machine rooms or a driving and return station.
236. Obstruction.

#### PART XIII—ROOFS

237. Construction of roof.
238. Design and installation of structural roof component.
239. Timber used for roof component.
240. Degree of non- combustibility of roof.
241. Waterproofing.
242. Flashing.
243. Flat roof.

---

PART XIV — WATER SERVICES, DRAINAGE, WASTE DISPOSAL  
AND STORM WATER DRAINAGE

- 244. Water management.
- 245. Compulsory drainage of building.
- 246. Design of drainage installation.
- 247. Control of objectionable discharge.
- 248. Disconnection of drainage installation.
- 249. Unauthorized works on drainage installation.
- 250. Inspection and testing of drainage installation.
- 251. Material, pipe, fitting and joint.
- 252. Sanitary fixture.
- 253. Water closet pan.
- 254. Urinal.
- 255. Electrical sanitary fixture.
- 256. Macerator type sanitary-towel disposer.
- 257. Sewage lift.
- 258. Conservancy tank, septic tank, french drain and soak pit.
- 259. Discharge from washing space.
- 260. Discharge from swimming pool, fountain or reservoir.
- 261. Provision of sanitary fixture.
- 262. Hydraulic loading of drainage installation.
- 263. Drainage system.
- 264. Sizing of discharge pipe.
- 265. Sizing of drain.
- 266. Protection of a water seal.
- 267. Sizing of ventilating pipe.
- 268. Installation of discharge pipe or ventilating pipe.
- 269. Access to drainage installation.
- 270. Rodding eye.
- 271. Provision of trap.
- 272. Provision of gully.
- 273. Installation of drain.
- 274. Test for discharge pipe or ventilating pipe.
- 275. In-situ percolation test for soil.

276. Storm-water disposal.
277. Valley, gutter or a downpipe.
278. Access to a storm-water drain.
279. Connection to storm-water sewer
280. Surface drainage system on road.
281. Drainage of storeyed building.
282. Drainage of roof.
283. Surface water.
284. Combined system of drainage.
285. Drain in road.
286. Material used and construction of drain or private sewer.
287. Inlet to drain to be trapped.
288. Drain or a sewer passing through or under a wall.
289. Tributary drain.
290. Manhole.
291. Ventilating pipe.
292. Soil pipe or ventilating pipe.
293. Access.
294. Waste pipe.
295. Maintenance of water seal in trap.
296. Water-closet.
297. Urinal.
298. Trough closet.
299. Floor water closet.
300. Bathroom.
301. Lighting and ventilation of water closets or urinal.
302. Building over sewer.
303. Effluent entering the environment or public sewer.
304. Trade effluent.
305. Manufacturing premises.
306. Matter not to be disposed in manner that damages sewer or drain.
307. Sewage and waste water disposal.
308. Radial arm.

- 309. Waste water storage tank.
- 310. Prohibition of waste water into an open channel.
- 311. Exemption.

PART XV—ELECTRICAL INSTALLATIONS

- 312. Applicable laws.
- 313. Conductor or apparatus.
- 314. Fuse, switch or circuit-breaker.
- 315. Precautions against metal becoming charged.
- 316. Isolation of system or apparatus.
- 317. Connection of appliance to electricity supply.
- 318. Precautions against special condition.
- 319. Voltage exceeding 200V.
- 320. Electrical appliance.
- 321. Light fitting, apparatus or appliance in room containing bath or shower.
- 322. Wiring diagram or distribution board.
- 323. Electric lighting.
- 324. Electricity point.
- 325. Protection against lightning.
- 326. Siting of power house.
- 327. Location and position of electrical appliance.
- 328. Telecommunication installation and other electrical installation.

PART XVI—LANDSCAPING

- 329. Landscape design considerations.
- 330. Landscape layout and planting design.
- 331. Provision for tree or shrub.
- 332. Minimum size of tree and shrub.
- 333. Maintenance of soft landscape.
- 334. Furniture and fixture in design of soft landscape.

PART XVII—INSPECTION AND MAINTENANCE

- 335. Periodic inspection of a building.
- 336. Procedure for building inspection.
- 337. Implementation of remedial works.

## PART XVIII— NON-WATER BORNE WASTE DISPOSAL

- 338. Means of disposal.
- 339. Prohibition of pit latrines.
- 340. Construction, siting and access.
- 341. Construction of closet.
- 342. Siting of a pit latrine.
- 343. Latrine or ablution.

## PART XIX—REFUSE DISPOSAL

- 344. Provision for refuse disposal.
- 345. Access to area designated for refuse disposal.
- 346. Waste container for building.
- 347. Waste container and chute.
- 348. Storage chamber.
- 349. Refuse chute.
- 350. Construction and situation of hopper.
- 351. Incinerator.

## PART XX—PEOPLE LIVING WITH DISABILITIES

- 352. Building plan design.
- 353. Initial access.
- 354. Ramp.
- 355. Dropped kerb.
- 356. Lift.
- 357. Corridor or lobby.
- 358. Door.
- 359. Water closet cubicle.
- 360. Handrail.
- 361. Wheel chair space.
- 362. Guest room.

## PART XXI—FIRE SAFETY AND FIRE INSTALLATIONS

- 363. Fire safety.
- 364. Firefighting lift.
- 365. Firefighting and rescue staircase.
- 366. Fire resistance in small house.
- 367. Garage attached to dwelling house.

- 
368. Modification of external wall of building.
  369. Separating wall.
  370. Buildings erected on single construction site for different tenancies.
  371. Fire-division wall.
  372. Wall separating flats.
  373. Fire resistance of floor, column, beam and wall.
  374. Ceiling of public building.
  375. Staircases for separate dwellings.
  376. Fire stop in cavity wall.
  377. Opening in external wall.
  378. Structural member supporting wall.
  379. External panel wall in framed structure.
  380. Residential or public buildings.
  381. Access from fire escape.
  382. Firefighting equipment.
  383. Division of building into components.
  384. Fire performance.
  385. Fire resistance of buildings of different occupancies.
  386. Fire stability of structural element or component.
  387. Tenancy separating wall.
  388. Partition wall and other partition.
  389. Protection of opening.
  390. Raised access and suspended floor for combustible material.
  391. Roof assembly and covering.
  392. Ceiling.
  393. Floor covering.
  394. Wall finish.
  395. Provision of escape route.
  396. Exit door.
  397. Feeder route.
  398. Emergency route.
  399. Dimensions of escape route.
  400. Basement.

401. Change in levels along escape route.
402. Ventilation of staircase in emergency route.
403. Opening in floor.
404. External staircase in passage.
405. Lobby, foyer or vestibule.
406. Marking or sign posting.
407. Lighting of feeder or emergency route.
408. Fire detection and alarm system.
409. Provision of fire-fighting equipment.
410. Water reticulation for fire-fighting purposes.
411. Hose reel.
412. Hydrants.
413. Sprinkler system.
414. Portable fire extinguisher.
415. Mobile fire extinguisher.
416. Fire stopping of inaccessible concealed space.
417. Protection in service shaft.
418. Building services in structural or separating element.
419. Smoke control.
420. Division into compartments.
421. Air-conditioning and ventilation system.
422. No smoking sign.
423. Lift well.
424. Lift design.
425. Firefighting lift.
426. Stretcher lift.
427. Stage and backstage area.
428. Seating arrangement in auditorium, hall or grandstand.
429. Parking garage.
430. Operating theatre or intensive care unit.
431. Installation of liquid fuel dispensing pump or tank.
432. Installation of other liquid petroleum tank.
433. Access to building for firefighting or rescuing purpose.
434. Presumed fire resistance of building material or component.

- 435. Non-combustible building material.
- 436. Surface fire index of material.
- 437. Fire index of floor covering.
- 438. Approved fire installation.
- 439. Supply of water.
- 440. Design of fire installation.
- 441. Water meter.
- 442. Isolating valve.
- 443. Fire installation.
- 444. Evacuation procedures.
- 445. Fire and evacuation plans.
- 446. Fire and evacuation instructions in a building.
- 447. Evacuation coordination instructions.
- 448. Records.
- 449. Owner of accommodation unit.
- 450. Maintenance of fire safety installation.

#### PART XXII—DEMOLITION OF BUILDINGS

- 451. Safeguarding of basement.
- 452. Damage to road.
- 453. Duties prior to commencement of demolition.
- 454. Provision for shoring.
- 455. Electric cable not to remain charged.
- 456. Preventing danger from fire or explosion.
- 457. Chute for removal of material.
- 458. Supervision of demolition works.
- 459. No floors or any other component to be overloaded.
- 460. Precautions to be taken in relation to cutting of steelwork.
- 461. Precautions to be taken in removing framing.

#### PART XXIII—DISASTER RISK MANAGEMENT ON CONSTRUCTION SITES

- 462. General principles of disaster prevention.
- 463. Co-ordination.
- 464. Owners' duty in relation to information.
- 465. Designs prepared or modified outside Kenya.



- 466. Duties of contractor.
- 467. Health and safety file.
- 468. Safe place of work.
- 469. Good order and construction site security.
- 470. Stability of structure.
- 471. Scaffold.
- 472. Working platform.
- 473. Guarding.
- 474. Preventing falling.
- 475. Suitable plank.
- 476. Ladder.
- 477. Position of material.
- 478. Securing and ventilation of working place.
- 479. Skip and bucket.
- 480. Safety measures when handling cement or lime.
- 481. Demolition works or dismantling works.
- 482. Explosive.
- 483. Excavation.
- 484. Cofferdam or caisson.
- 485. Reports.
- 486. Prevention of drowning.
- 487. Traffic route.
- 488. Vehicle in construction site.
- 489. Prevention of risk from fire and other hazards.
- 490. Emergency procedures.
- 491. Emergency route or exit.
- 492. Fire detection and firefighting.
- 493. Fresh air.
- 494. Temperature and weather protection.
- 495. Lighting.

PART XXIV—ACCESS ROADS, CUL-DE-SACS AND OTHER  
PRIVATE ROADS

- 496. Private road.
- 497. Footpath.

- 
- 498. Width of private road or cul-de-sac.
  - 499. Width of access road.
  - 500. Kerb radius.
  - 501. Junction to be at right angle.
  - 502. No undulation onto major road.
  - 503. Gradient.
  - 504. Horizontal curve.
  - 505. Vertical curve.
  - 506. Widening of private road or cul-de-sac on curve.
  - 507. Turning space for vehicle in cul-de-sac or access road.
  - 508. Surfacing of private road, cul-de-sac or access road.
  - 509. Surfacing of service lane.
  - 510. Kerbstone.
  - 511. Height of a kerb.
  - 512. Camber at cross fall.
  - 513. Grade of manhole cover or grating.
  - 514. Shape of manhole cover.
  - 515. Drainage of private road.
  - 516. Channel in private road.

PART XXV—MISCELLANEOUS

- 517. Revocation of L. N. 15 of 1968.

SCHEDULES

FIRST SCHEDULE—TABLES

SECOND SCHEDULE—FIGURES

THE NATIONAL CONSTRUCTION AUTHORITY ACT,  
(Cap. 118)

THE NATIONAL BUILDING CODE, 2024

IN EXERCISE of the powers conferred by section 42 (2) (aa) of the National Construction Authority Act, the Cabinet Secretary for Lands, Public Works, Housing and Urban Development, in consultation with the Board of the National Construction Authority, makes the following Code—

PART I—PRELIMINARIES

1. This Code may be cited as the National Building Code, 2024 and shall come into operation one year after publication. Citation and commencement.
2. In this Code, unless the context otherwise requires— Interpretation.
  - “access opening” means an entrance leading to a building or structure;
  - “Act” means the National Construction Authority Act, 2011; No. 41 of 2011.
  - “additive” means any material added to a liquid or granular material, to produce the desired modification to its properties;
  - “aggregate” means any inert material which forms the greater part of concrete;
  - “air changes” means the amount of air flowing into or out of a space by natural or mechanical means and measured against the volume of the space;
  - “air conditioning” means the process of treating air within a space in such a manner that simultaneously controls the temperature, humidity, purity, distribution and flow of the air in the space;
  - “air duct” means a pipe, tube, conduit or enclosed space, in any building that is used or intended to be used, for the flow of air from an artificial ventilation system;
  - “air handling system” means a system which supplies air in a positive and controlled manner to a specific enclosure by means of at least one air-handling unit, ducts, plenums, air distribution devices or automatic controls;
  - “airshaft” means an open space surrounded by the walls of a building or biddings to enable ventilation by a window;
  - “anchorage” means an item used to hold a load bearing bar, wire or bolt;
  - “apparatus” means equipment, a machine, or fitting in which conductors are used, or of which conductors form a part;
  - “appliance” means a device which is powered by electricity, but does not include a light fitting or an independent motor;
  - “approving authority” means the County Executive Committee Member responsible for physical and land use planning;

“architect” means a person who is registered as such in accordance with the Architects and Quantity Surveyors Act;

Cap. 525.

“artificial ventilation system” means a system in which air is caused to circulate through a room by means of a mechanical apparatus;

“asphalt” means a mixture of bitumen and mineral aggregate;

“atrium” means an open court located within a building or a covered central area of a high-rise building;

“backfill” means an earth refill of a trench or an excavation around a building or bridge abutment;

“back vent” means a ventilating pipe which is connected to a branch discharge pipe, or to which unvented fixture discharge pipes are connected to a vent stack or to a stack vent;

“baffle plate” means a plate which prevents the flow of a fluid in the direction in which it would normally flow, and directs the flow into the desired path;

“balcony” means a stage, platform, oriel window which projects outwards from or recesses into, the wall of a building and is supported by brackets or cantilevered;

“balustrade” means a protective barrier which is formed by a series of light vertical members which are surmounted by a handrail;

“balustrade wall” means a wall which performs the functions of a balustrade;

“basement” means a storey of a building which is partially or completely below the ground level;

“base course” means the lowest or first course of a wall, or the first layer of material laid down, in the construction of a pavement or road;

“batten” means a small section, usually made of timber, to which sheet materials, slates or tiles, are fixed to an exterior wall, floor or roof;

“beam” means a structural member which is designed to carry a load between or beyond points of support, and is usually narrow in relation to its length and horizontal;

“block” means a masonry unit which is used in construction works and which has a length of at least 300mm or a width of at least 130mm;

“bond” means an arrangement of masonry units or adhesion between materials;

“boundary” in relation to a building or compartment, means the demarcation of a construction site;

“boundary wall” means a wall, fence, enclosure or screen, which is constructed along the boundary or building line, and which distinguishes the construction site from an adjoining construction site;

“bracing” means a system of structural members which when acting in compression or tension, supports and strengthens a frame to resist horizontal forces;

“bracket” means a support which projects horizontally from a vertical surface;

“branch discharge pipe” means a horizontal discharge pipe which conveys discharge from at least one sanitary appliance;

“branch drain” means the communicating drain which is installed between a gully, soil pipe or sanitary fitting, and the main drain;

“branch vent” means a horizontal discharge pipe which connects at least two trap vents, to a vent stack or to a stack vent;

“brick” means a rectangular block which is usually made of fired or sundried clay;

“bridge abutment” means the end support of a bridge which connects a structure to the ground;

“building” means construction works which are used as shelter for an occupant or items contained therein;

“building component” means a drawing which indicates the basic sizes, system of reference and performance drawings;

“building element” means a major functional part of a building;

“building line”—

- (a) means a line prescribed by the approving authority on either side of a road beyond which no building abutting the side shall traverse; or
- (b) in relation to a construction site, means a line prescribed in any town planning scheme or any other law designating the boundaries of the area of the construction site beyond which the erection above ground of any building is prohibited;

“building of the warehouse class” means a building designed or used as a warehouse, go-down or factory, or for carrying on a wholesale business, but does not include any living accommodation which may form part of or be annexed to the building, and the formation of an access to a construction site;

“building plan” means a drawing of a building done to wit;

“building services” means infrastructure and systems installed in buildings to make them comfortable, functional, efficient and safe and includes electrical, plumbing, mechanical, fire safety, and information and communications technology services;

“building surveyor” means person registered as a building surveyor under the Building Surveyors Act, 2018;

No. 19 of 2018.

“buttress” means—

- (a) an upright projection which supports or resists lateral forces in a building; or

(b) a pier constructed at right angles to a restraining wall on the side opposite to the restrained material,

which increases the strength and thrust resistance of the wall;

“caisson” means a structure which is used as a foundation under water;

“camber” means a deviation from a straight line which is applied to a convex, edgewise sweep or curve, or to the increase in diameter at the centre of rolled material;

“canal” means an artificial open waterway is used for transportation, water power or irrigation;

“canopy” means —

(a) a roof like ornamental projection, over a niche, door or window; or

(b) a covering, an overhanging shade or shelter used especially of the firmament;

“cantilever” means a projecting beam, truss, or slab which is only supported at one end;

“carriageway” means a part of a private road, cul-de-sac or access road which is used for vehicular traffic;

“casement” means a component, whether fixed or as an opening, which consists essentially of a frame the infilling of which consists of glazing, a grille, a solid panel or slats;

“cast-in-situ” means —

(a) a cast in place; or

(b) a cast liquid in its permanent location, where it hardens as part of the building;

“catwalk” means a narrow-raised platform or pathway which is used as a passage to otherwise inaccessible areas;

“cavity wall” means a wall constructed of two separate thicknesses with an air space in between and includes a hollow wall;

“ceiling” means a part of a building made of plaster, boards, or other material which cover the underside of a floor or roof and which provides the overhead surface of an enclosed space;

“cement” means a finely ground compound which, when mixed with water hardens and adheres to an aggregate which is in accordance with KS EAS 18 (Cement-Part 1: Composition, specification and conformity criteria for common cements);

“chase” means a groove cut into a wall or floor in which a small pipe, conduit, cable or flashing may be installed;

“chemical closet” means a closet with a fixed pan, the excreta from which passes into a tank where chemicals sterilize and break down the excreta;

“chimney” means a vertical, hollow structure of masonry, steel, or concrete, which conveys gaseous products of combustion from a building;

“circuit” means an arrangement of conductors which transmits electric current;

“circuit breaker” means an electro-mechanical device which makes or breaks a circuit under a normal or abnormal condition, and in the event of a short circuit, the circuit can break automatically;

“circulation space” means a space which is solely or predominantly being used as a means of access—

- (a) between a room and a protected shaft; or
- (b) between a room or a protected shaft, and an exit from the building or compartment;

“cistern” means a tank or open vessel in a water supply system, which stores water at atmospheric pressure;

“cladding” means to furnish, surround, adorn, cover, conceal the exterior of a building;

“cleaning eye” means an access opening at the interior of a discharge pipe or trap which is installed and is can be used for internal cleaning, and which remains permanently accessible after completion of the drainage installation;

“clearance” means the distance between two objects, or between a moving and stationary part of a system;

“clear span” means the distance between opposite sides of a support;

“cofferdam” means a water tight enclosure that is pumped dry and used when constructing under water;

“column” means a structural member of slender form, usually vertical, which transmits the forces, primarily in compression, that are applied to it, to the base of the member;

“combustible” in relation to a material, means a material which cannot withstand the non-combustibility test approved by KS 2804-1 (Fire classification of construction products and building elements - Classification using data from reactions to fire tests);

“combustion” means the burning of gas, liquid or solid, in which the fuel is oxidized, evolving heat and often light;

“commercial building” means any building which is wholly or partly used for conducting business;

“common drain” means the part of a drain which is conveys sewage from the construction site through which the drain runs and sewage which does not emanate from the construction site through which the drain runs;

“common staircase” means a staircase which is used to access to a storey that is let in separate tenancies;

“common waste pipe” means a waste pipe to which more than one pipe is connected in a storey;

“communication pipe” means a pipe to which any water installation is connected;

“compartment” means—

- (a) a part of a building which is separated from all other parts by a compartment wall or floor; and
- (b) where a part of the top storey of a building is within a compartment, the roof space above such part of the top storey;

“component” means a product manufactured as a distinct unit and which is performs a specific function;

“composite building” means a building which is constructed or used as a combination of at least two of the following—

- (a) as a domestic building;
- (b) as a commercial building;
- (c) as an institution; or
- (d) as a hotel;

“concrete” means a mixture of cement, sand, and gravel, with water, in varying proportions according to the use for which the mixture is made;

“concrete slab” means a rigid horizontal or nearly horizontal surface with a large area relative to its thickness and which is constructed from concrete;

“conductor” in relation to a core or a cable, means the conducting portion of the cable or core, which consists of a single wire or group of wires, in contact with each other;

“conduit” means a natural or artificial channel which conveys fluids or in which electrical cables are installed;

“connecting sewer” means a pipe which connects a drain to a sewer, installed by the county government;

“conservancy tank” means a covered tank without outflow which is used for the reception and temporary retention of sewage;

“conservatory” means a glazed building in which plants may be cultivated under controlled atmospheric conditions;

“construction site” means the parcel of land on which construction works are undertaken;

“construction works” has the meaning assigned to it in section 2 of the Act;



“contractor” has the meaning assigned to it under in section 2 of the Act;

“coping” means a cap made of stone, brick or concrete that is constructed at the top of a wall and which provides an occupant underneath it protection from harsh weather or is used for decorative purposes;

“cornice” means an ornamental moulding installed along the wall of a room just below the ceiling;

“corridor” means a narrow and enclosed circulation space which enables access to rooms or spaces;

“coupling” means a device for connecting two lengths of a hose;

“crane” means a hoisting machine which is equipped with a power-operated inclined or horizontal boom and lifting tackle, which moves loads vertically or horizontally;

“cross vent” means a ventilating pipe which connects a discharge stack to a vent stack;

“crushing strength” means the compressive strength of concrete ascertained by crushing a concrete cylinder or cube, and which is expressed as the ultimate load per unit of cross-sectional area;

“cul-de-sac” means a dead-end road which has a circular area for turning around;

“culvert” means a covered channel or a large diameter pipe, which enables a watercourse below ground level;

“curtain wall” means a thin wall of glass, which covers the exterior surface of the building, and which is supported by the structural frame of the building;

“darkroom” means a room which is illuminated only by a safe light for processing light sensitive materials;

“dead load” means a non-varying load which is permanently applied to a structure and which is acting at all times;

“deck” means a load bearing concrete slab or sub-floor of a bridge;

“deflection” means the flexural deformation of a structural member;

“demolition” means to destroy, pull down, reduce to ruin by disintegration;

“detached building” means a building not attached to another;

“developed length” in relation to a pipe, means the length between two specified points on the pipe when measured along the centre line of such pipe, and includes any bend, junction or similar fitting to the pipe;

“diagram” means a drawing of a building, either to scale or not, which indicates only a simplified representation of the functions of the

parts of the building, the access, circulation, installations and their mode of operation in the building;

“dimension” means a measure of distance in a given direction or along a given line;

“disability” includes any physical, sensory, mental, psychological or other impairment, condition or illness that has, or is perceived by significant sectors of the community to have, a substantial or long-term effect on an individual’s ability to carry out ordinary day-to-day activities;

“discharge pipe” means a pipe which conveys discharge from a sanitary fixture to a drain, and includes a soil pipe, waste pipe, discharge stack, branch discharge pipe or a fixture discharge pipe;

“discharge stack” means a vertical discharge pipe which conveys discharge from at least two sanitary fixtures and which is connected directly to a drain;

“division” means a portion of a building which is separated from the rest of the building by at least one separating element;

“division wall” means an internal wall which separates one division from another and has a fire resistance of not less than that required by this Code;

“door” includes a shutter, cover or other barrier installed at an opening, in a wall or floor, or in the structure surrounding a protected shaft whether or not the door is installed on only one level;

“door frame” means a solid frame on which a door is installed;

“down pipe” means a pipe, which is usually vertical, and which conveys rainwater from the gutter to the drain or to an intermediate gully;

“drain” means a part of a drainage installation which is constructed or installed outside a building and below ground level, but does not include a discharge pipe and the bend at the foot of a discharge stack;

“drainage installation” means an installation which is situated and intended for the reception, conveyance, storage or treatment of sewage, and includes sanitary fixtures, traps, discharge pipes, drains, ventilating pipes, septic tanks, conservancy tanks, sewage treatment works and mechanical appliances associated therewith;

“drainage system” in relation to a building, means a system of pipes and sewers that are installed in the building and which enable sewerage of a building, and includes any fitting, appliance or equipment connected therewith;

“drawing” means a document which contains graphical forms, sketches, drafts and measurements, which indicates the general intentions of the drawer;

“drencher system” means a system of piping and outlets which, when actuated manually or by the action of fire, releases a continuous curtain of water;

“duct” means an enclosing construction which enables the passage of air, gases, or the installation of cables, and pipes;

“dwelling” means a building or structure which is used, whether regularly or intermittently, for human habitation;

“dwelling house” means a single dwelling unit and includes a garage and any domestic outbuilding that is situated on a construction site;

“dwelling unit” means a building which contains at least one habitable room and adequate sanitary facilities for accommodation;

“dynamic load” means a load which is not static;

“earthed” in relation to a conductor, means being effectively connected to the general mass of the earth;

“earthquake loading” means the forces exerted on a structure by seismic activities;

“earthwork” means the excavation or construction of earth embankments;

“eaves” means the lower edges of a pitched roof or the edge of a flat roof overhanging a wall;

“eccentric load” means a load imposed on a structural member at a point other than at the centroid of a section;

“effluent” means water which has been combined with waste;

“electrical sanitary device” means a device which is connected to an electricity supply, a water supply system and a drainage system;

“electricity point” means the termination point of fixed wiring which is intended to be attached to a lighting fitting or a device, for connecting electricity supply to an appliance;

“elevation” means a vertical view of a building, structural element or building component;

“emergency lighting” means a system of artificial lighting designed to provide adequate illumination and indication of exit routes within a building under emergency conditions;

“emergency route” means the part of an escape route which provides fire protection to the occupants of the building and which leads to an escape door;

“engineer” means a person who is registered and licensed under the Engineers Act, 2011;

“entrance hall” means a large circulation space within a building situated immediately at the entrance;

“escalator” means mechanically operated moving stairs;

“escape door” means the door in an escape route which, at ground level, leads directly to a road or public place, or to any approved open space which leads to a road or public place;

“escape route” means the entire path of travel from the furthest point in any room in a building to the nearest escape door and may include an emergency route;

“excavation” means digging, lifting and removing earth or fill;

“exhaust gas” means the spent gas emitted from an internal combustion engine or gas turbine;

“existing building” means a building in respect of which a certificate of statutory completion or a temporary occupation permit has been issued;

“exit” means an opening or passage that enable an occupant to leave a building, and includes a protected passage that is used as a means of escape in the event of a fire;

“exit door” means a door that is a component of an escape route from a room;

“exit sign” means a fixed illuminated sign which indicates an approved exit route;

“expansion joint” means a joint between the parts of a structure which avoids distortion when subjected to temperature change;

“external panel wall” means a part of an external wall which forms an in-filling between structural members;

“external wall” means an outer wall or vertical enclosure of a building which is not a party wall even though the wall or enclosure may adjoin a wall of another building;

“extract fan” means a fan which extracts foul air, fumes or suspended particles, from a working area;

“fanlight” means a window that was originally a fan-shaped window with sash bars radiating like ribs of a fan located over a door;

“feeder route” means the part of an escape route which allows travel in two different directions to the access doors to at least two emergency routes;

“felt” means a fibrous, watertight heavy paper of organic fibres impregnated with asphalt and used as an overlining or underlining for roofs;

“fence” means a guard or stop to limit motion;

“fibre plaster” means gypsum plaster containing hair or wood fibre as a binder;

“fill” means material used for raising the level of the ground;

“finishing” means the final covering and treatment of surfaces and their intersections;

“fire alarm system” means an automatic or manually operated system designed to give a warning of fire;

“fire compartment” means an enclosed space in a building that is separated from all other parts of the building by enclosing construction providing a fire separation that may be required to have a fire-resisting rating;

“fire damper” means an airtight stopper to prevent the inflow of fresh air and the outflow of foul air, whose assembly is in accordance with relevant standards developed under the Standards Act;

Cap. 496.

“fire detection system” means a system designed to automatically detect the presence of smoke or heat;

“fire door” means a door which is designed to provide fire resistance for specific periods of time depending on its grading and includes the frame of the door;

“fire extinguisher” means a portable device used to extinguish a fire by the ejection of a fire-inhibiting substance, such as water, carbon dioxide, gas or chemical foam;

“fire hose reel” means a collapsible flameproof hose reeled on a drum attached to a water outlet to supply water to extinguish a fire;

“fire hydrant” means an installation of pipes, water tanks, pumps, hydrant outlets or hose reels, or a pipe of water from main with nozzle for hoses;

“fire load” means the theoretical amount of heat that may be released during the burning of combustibles in the building under fire conditions and is computed by the formula:

Calorific value of contents in mj/kg x weight of contents in kg per floor area m<sup>2</sup>;

“fire protected route” means a route protected from fire and smoke;

“fire resistance” in relation to an element of structure, means capability to resist the action of fire for a specified period as prescribed under the Standards Act;

“fire stop” means a form of passive fire protection that—

- (a) is designed to maintain the fireproofing of a wall or floor assembly allowing it to impede the spread of fire and smoke; and
- (b) used to seal around openings and between joints in a fire-resistant wall or floor assembly;

“firefighter’s lift” means a designated lift so designed as to allow fire services personnel safe access to at least all alternate floors of the building;

“fitment” means an article such as a sanitary appliance or kitchen unit that equips spaces for people’s use and is fixed to a building;

“fixture” means an item that is fixed to a building or land, and would cause damage if removed;

“fixture branch” means a horizontal fixture discharge pipe;

“fixture discharge pipe” means a discharge pipe that conveys the discharge from single sanitary fixture;

“fixture unit” means an arbitrary unit of measure for expressing the hydraulic loading on a drainage installation;

“fixture unit rating” means the value in fixture units assigned to a sanitary fixture from a consideration of the duration of its discharge, the interval between discharges and its mean discharge rate;

“flammable” means having a closed-cup flash point lower than 32°C;

“flashing” means a strip of sheet metal placed at the junction of exterior building surfaces to render the joint airtight;

“flash point” means the lowest temperature at which vapours from a volatile liquid will ignite momentarily upon the application of a small flame under specified conditions where the conditions can be either open- or closed-cup;

“flat” means a horizontal stratum of any building or part thereof, whether such stratum is on one or more levels or is partially or wholly below the surface of the ground, which is used or intended to be used as a complete and separate unit for the purpose of habitation or business or for any other purpose;

“flat roof” means a roof having no inclination or having an inclination of not more than 7.5°;

“flexure” in relation to the rigidity of structures, means the resistance to bending;

“flight” means the part of a staircase which is of consecutive steps;

“floor” means a base or structure between the surface of the ground or the surface of any hardware laid upon the ground and the upper surface of the floor;

“floor area” in relation to a building or a storey thereof, means the total area enclosed within its external walls, exclusive of the area occupied by any lift well;

“flooring” means the upper layer of a floor providing a finished surface;

“flue” means a passage which conveys the discharge of a heat generating appliance to the external air;

“flue pipe” means a pipe forming a flue but does not include a pipe as a lining to a chimney;

“footway” means a pedestrian walkway (whether open or covered) at the side of any road or a portion of right of way designated to accommodate pedestrians;

“foul water” means a water-borne human or animal excrement or industrial solids and includes waste water conveyed in underground pipes;

“foundation” means the part of a construction immediately below the footings of a building which is in direct contact with and through which the weight of a building is transmitted to the ground, and includes piling works;

“foundation wall” means a wall between the foundation and the lowest floor above such foundation;

“frame” means a structure principally composed of structural members; or the surrounding construction of members on to which a door leaf or window casement is hinged;

“framework” means the supporting skeleton of a structure;

“french drain” means a trench filled with suitable material which is used for the disposal of liquid effluent from a septic tank or waste water;

“fuse” means a device for opening a circuit by means of a conductor designed to melt when excessive current flows;

“gable” means the upper triangular portion of a terminal wall of building under the ridge of a sloped roof;

“gable wall” means a wall of which a gable forms a part;

“gallery” means a wide corridor, generally an upper storey, walled on one side only;

“galvanized mild steel” means steel of medium carbon content coated with zinc;

“gangway” means a principle underground haulage road; or a passageway into or out of an underground mine;

“garage” means —

- (a) a frame erected on side supports so as to span an area and support and hoist machinery and heavy materials;
- (b) premises or part thereof that is used for repairing, painting, washing, storing, housing or parking of motor vehicles; or
- (c) premises where a pump is maintained from which petrol or oil is supplied to motor vehicles;

“girder” means a primary beam which supports secondary beams as opposed to a joist;

“glass fibre” means a glass thread less than 25µm thick, used loosely or in woven form as an acoustic, electrical, or thermal insulating material and as a reinforcing material in laminated plastics;

“glazing bead” means a bead nailed instead of putty to secure a pane;

“glazing” means cutting and fitting panes of glass into frames;

“going” means the horizontal distance between the front of a nosing and the front of the next nosing or landing;

“granolithic” means a rendering of cement and fine granite clippings, used as a covering for concrete floors, on which it is floated in a layer of a thickness of between 25mm to 50mm and is used because of its hard-wearing properties;

“grating” means a support made of closely spaced bars within a small opening to hold up solid matter while allowing liquids to pass through;

“gravel” means naturally occurring deposits of unconsolidated sediment ranging from about 5mm to 75mm;

“grease trap” means a chamber in drainpipe to trap grease in wastewater;

“grille” means an open screen for division of space or within a comparatively large wall or ceiling opening, that is intended for burglar proofing;

“grinder” means a device or machine that grinds and includes a grinding wheel;

“gross floor area” means the total floor area contained within a building, that is measured to the external face of the external walls for each floor level;

“ground” means—

- (a) the solid land underlying an area of water;
- (b) the solid surface of earth;
- (c) the foundation;
- (d) in relation to painting a building, first coat of paint;
  - (i) the first coat of paint; or
  - (ii) to cover with a layer of plaster as basis for painting; or
- (e) an area of land attached to, or surrounding, a building;

“ground level” means a horizontal plane on the surface of the earth;

“ground storey” means a storey the floor level of which is not more than 1 m at any point below the level of the adjacent finished ground level, or, if there are at least two such storeys, the lower or lowest of the storeys;

“gully” means a pipe fitting incorporating a trap into which wastewater is discharged;



“gypsum” means the commonest sulphate mineral crystals that are monolithic, clear, white to grey, yellowish or brownish in colour with well-developed cleavages;

“habitable room” means a dwelling room which has a minimum superficial area of 7m<sup>2</sup> for a single room occupancy and an internal dimension of at least 2.1m;

“hazardous substance” means any chemical, waste, gas, medicine, drug, plant, animal or microorganism which is likely to be injurious to human health or the environment;

“headroom” means the minimum actual or required unobstructed vertical distance from a given reference point;

“heat island effect” means high temperature in the city centres than its’ surroundings known as the Urban Heat Island effect, which is causes discomfort to the urban dwellers;

“highway” means a main public road, particularly one connecting large towns or cities;

“high rise building” means a building of which the floor or the uppermost storey exceeds 30m above the point of staircase discharge at ground floor level;

“hopper” means a funnel shaped receptacle with an opening at the top for loading and a discharge opening at the bottom;

“horizontal” in relation to a discharge pipe or ventilating pipe, means inclined at less than a 45° slope;

“hostel” means a residence for students or for another group of persons;

“hotel” means a building used wholly or in part primarily for the purposes of accommodation on a commercial basis;

“house” includes any part of a building which is occupied or intended to be occupied as a separate dwelling, and includes a flat, a building or tenement wholly or partly constructed, adapted, or intended for human habitation and as a business premises;

“hydraulic cement” means finely ground inorganic material which forms, by addition of water, a binding paste which hardens both under water and in air, and binds together granular material;

“hydraulic lift” means a lift or elevator operated either directly by a long vertical ram working in a cylinder to which a liquid is admitted under pressure, or by a shorter ram through ropes;

“illuminate” in relation to any advertisement, signboard, or sky-sign means to illuminate by design or adoption by an internal or external artificial source of light directly or by reflection;

“imposed load” means the load assumed to be introduced by the intended occupancy or use, and includes distributed load, concentrated impact load and inertia;

“industrial effluent” means a liquid containing matter as a solution, a suspension or organic pollutant, discharged from an industry;

“inspection chamber” means a subterranean chamber not deeper than 750 mm and with a removable cover at ground level, usually located outside a building to provide open access for inspection and maintenance of a drainage or sewerage;

“insulating material” means a material for preventing or reducing the passage of heat, sound or electricity;

“insulation” means the prevention of the flow of an electric current, or the retardation of the flow of heat or the passage of sound;

“invert level” means a relative level of drainage to manhole;

“ironmongery” means a small component usually metal, that is used mainly for the operation or support of doors, windows and joinery fittings;

“jack” means a portable device for lifting heavy loads through a shorter distance, operated by a lever, a screw or hydraulic press; A connecting device into which a plug can be inserted to make circuit connections;

“joinery” means an assembly of worked timber components and panel products other than structural timber or cladding;

“joist” means one of a series of parallel beams, usually horizontal;

“kerb” means the stone, concrete or tile edging which separates a pavement or sidewalk from a road surface;

“landing” means a platform between two consecutive flights of a staircase;

“lantern light” means a sky light with flat, glazed vertical sides, rising from the roof of a building, as distinct from a skylight lying almost flush with the covering of a sloping roof;

“lateral boundary” means a boundary of a construction site other than a boundary between the construction site and any road or public place with a width of more than 6m measured at right angles to such boundary;

“lateral forces” means forces acting on a structure or structural member in a transverse direction;

“lath” means a sheet of material that is used in making a level base, in constructing a light framework or as a base for plaster;

“lavatory” means a room where a toilet, water closet, urinal or any other receptacle for foul water is installed;

“leaded lights” means a window consisting of relatively small pieces of glass often diamond shaped;

“lift” means a mechanical device that transports goods or people vertically from one floor to another within the same building;

“lift car” means a part of the lift designed to receive people or loads to be transported;

“lift well” means a space in which the lift car and counter weight, if any, move that is materially enclosed by the bottom of the pit, vertical walls and the ceiling;

“lining” means a dry covering to any internal building surface;

“linked switch” means a switch, the blades of which are linked mechanically so as to make or break all poles simultaneously or in a definite sequence;

“intel” means a beam supporting loads over an opening;

“live” in relation to a conductor, means an electrical cable that carries an electrical current;

“live wire” means a conductor which has a difference in voltage between the conductor and earth;

“load” means force to which a building is or may be subjected, and includes dead, imposed, wind and seismic loads and forces caused by dimension changes of materials;

“load bearing” in relation to a part of a building (including its foundation) means that part of a building which bears a load other than that due to its own weight and wind pressure on its surface;

“loading bay” means a raised construction work to facilitate the loading and unloading of vehicles at a factory, commercial establishment or warehouse;

“lobby” means a small enclosed circulation space giving access to rooms or spaces;

“loft” means an accessible space not intended for frequent habitation;

“louvres” means an arrangement of overlapping boards, laths or slips of glasses, admitting air and light but excluding rain, on a domed turret-line erection on the hall-roof;

“lux” means a unit of illumination, equal to the illumination on a surface 1m<sup>2</sup> in area on which there is a luminous flux of 1lm uniformly distributed, or the illumination on a surface all points of which are at a distance of 1m from a uniform point source of 1cd;

“macadam” means an aggregate or crushed rock compacted for use in road construction;

“main drain” means the longest run of drain from a building to a common drain, to a means of sewage disposal situated on the construction site concerned, or to a connecting sewer;

“maisonette” means a dwelling that exceeds one storey attached to other building;

“major road” means a road categorised as such by the approving authority;

“manhole” means a chamber of a depth greater than 750mm and of such dimensions that allows entry of a person into such chamber for the purpose of providing access to a drain;

“masonry” means a construction of stone or similar materials such as concrete blocks or bricks;

“mechanical” means relating to or concerned with machinery or tools;

“mezzanine floor” means an intermediate storey of lower height; usually a gallery between the main floor and the floor above, the floor area of which does not exceed 25% of the floor below it;

“mineral wool” means a natural fibre of mineral origin resembling wool or glass fibre and formed by blowing air or steam through molten rock or slag, used for insulation and fire proofing and as a filter medium;

“minor road” means a road categorised as such by the approving authority;

“mortar” means a pasty substance formed normally by mixing of cement, sand and water in varying proportions that hardens after application and is normally used for the binding of brickwork or masonry;

“moulding” means a continuous contour surface of rectangular or curved profile, used on a plane surface such as a wall to affect a transition or create a decorative effect by the play of shadow or light;

“mullion” means an intermediate vertical member in an opening or frame;

“multi-purpose room” means a one-roomed unit of accommodation typically consisting of combined bedroom and sitting room with cooking facilities;

“multi-dwelling unit” includes an apartment, flat, duplex and tenement;

“natural stone” means a stone which has been quarried and cut but not crushed into chips and reconstituted;

“natural ventilation” means the supply of outside air to a building or removal of inside air from a building by means of windows and other openings;

“noise rating number” means the number as a single index obtained from an octave band analysis of a noise;

“non-combustible” means a substance or material that is classified as non-combustible when tested in accordance with the relevant standards developed under the Standards Act;

“non-load bearing wall” means a wall which supports no load other than its own weight;

“non-structural wall” means a wall which does not form part of a structure but which may be subjected to forces other than its own weight;

“nosing” means the projection of a tread of a stair beyond the riser below it;

“nuisance” means what constitutes a nuisance in accordance with section 118 of the Public Health Act;

Cap. 242.

“obstruction” means a building or other object which partially or completely intersects any zone of space serving a window but does not include any narrow object such as a pole or railing which does not materially obstruct the entry of light and air to the opening concerned;

“occupancy” means the particular use or the type of use to which a building or portion thereof is normally put or intended to be put;

“occupant load” in relation to a public building means the total number of persons who may use or occupy the public building at any time;

“occupier” means the person in temporary or subordinate possession of a building or any part thereof;

“oil” means a petroleum product that has a flash point that does not exceed 34oC;

“one-pipe system” means a system of piping between sanitary fixtures and a drain in which both waste and soil water discharge down a common discharge stack and in which any trap venting or other venting that is required may be via a common vent stack;

“opening” means a window or door on an external wall;

“open space” means a part of a construction site that is accessible to the public and includes a green space (park, community garden or cemetery), foot path, road and open square, public open-air market, public toilet, public sport stadium, boulevard, roundabout, school playground, plaza, vacant lot and property frontage;

“operation” includes any act of construction or demolition of construction works on a construction site;

“outside air” means air which is drawn into the building from the outside which has not been circulated through the building;

“overflow” means a device or structure that conducts excess water or sewage from a conduit or container, and includes the excess liquid which overflows;

“overflow level” means the level at which an overflow is fitted;

“owner” means a person registered as the proprietor of a construction site and holds the legal ownership document over that construction site;

“paint” means a product in liquid, solid, powder or powder coating form that contains at least one pigment, that when applied to a surface forms, an opaque, hardwearing film having protective, decorative, or other specific technical properties;

“pane” means a sheet of glass cut to size for use as a window light;

“panic bolt” means a special form of door bolt which is released by pressure at the middle of the door; often used in fire escape doors;

“parapet” means a low wall, barrier or balustrade at the edge of a roof, balcony, terrace, bridge or embankment or a junction at which an external wall and a flat roof meet;

“parkland” means an open grassy land with scattered groups of trees;

“partition” means an interior wall that has a height of one storey or less, which divides a space into sections, and is generally made of a light construction material that is demountable;

“partition wall” means a non-structural internal wall extending to the ceiling and constructed for the purpose of subdividing a space;

“party wall” means a wall forming part of a building and used or constructed to be used for the separation of adjoining buildings or land belonging to different owners or intended or constructed or adapted to be occupied by different persons;

“passage” means an area in a building serving as a transit from one place to another;

“passive stack” means a ventilation system using ducts from the ceilings of rooms to terminals on the roof, which operate by a combination of the natural stack effect, such as the movement of air due to the difference in temperature between inside and outside, and the effect of wind passing over the roof of the dwelling;

“patent defect” means a defect which is detectable upon reasonable inspection and can be notified to the Contractor either before practical completion or during the defects’ liability period;

“pavement” means an external construction work providing the surfacing and base mainly for use by pedestrians;

“pelmet” means a built -in head to a window for hiding the curtain rail;

“perlite” means a volcanic glass usually with a higher water content than obsidian which can be expanded by heating and may be used as an insulating material and as lightweight aggregate;

“petroleum gas” means gas that has been subjected to pressure to keep it in a liquid state, used as fuel for domestic and industrial use;

“picture rail” means a moulding fixed to an interior wall from which a picture or decoration may be suspended by means of metal hooks which fit over the top of the moulding;

“pier” means a vertical load-bearing member between two openings;

“pile” means a columnar foundation element which is pre-manufactured and inserted into the ground by driving, jacking or another method; or cast-in-place in a shaft formed in the ground by boring, excavating or inserting a shell;

“pipe fitting” means a component fitted to a pipe for such purposes as connecting, controlling, supporting, or changing its direction or bore;

“pipeline” means a line of pipe connected to valves and other control devices, for conducting fluids, gases or finely divided solids;

“pitch line” means a theoretical projection produced if a line is strung across the tip of each nose on the treads of a staircase;

“pitched roof” means a sloping roof, usually has a pitch of at least 10o;

“plain concrete” means concrete in which no reinforcement is included for the structural purposes but in which reinforcement may be provided for the purpose of restraining shrinkage or other movement;

“plan” in relation to any building works, includes drawings, details, diagrams, calculations, structural details, and structural calculations showing or relating to the building works;

“plan area” in relation to a floor, ceiling or roof means the area thereof measured in plan;

“plant” means machinery and heavy equipment installed for operation of a service (for example, heating or ventilating service) and includes the implements, machines and other items employed in construction works;

“plaster” means a pasty material of mortar-like consistency based on lime, hydraulic cement or gypsum (calcium sulphate dihydrate), with or without the addition of aggregates, fibres or other materials, that is usually used for coating internal wall and ceiling surfaces and hardens after application;

“plaster board” means a building board made of a core of gypsum plaster and faced with two sheets of heavy paper;

“plate” means a metal structural element that is united to a tie beam, rafter and a post all in a compact and structurally sound manner;

“platform” means of a lifting gear and which is raised or lowered by lifting appliances, lifting gear, counter weights, ballast, outriggers and other supports, and includes the whole of the mechanical and electrical apparatus required in connection with the operation and safety of the platform;

“plenum system” means an air conditioning system in which the air propelled into the building is maintained at a higher pressure than the atmosphere and is usually admitted to rooms at the point of a wall

that is 2.5m to 3m above floor level, while the ventilated air is extracted at floor level on the same side of the room;

“plinth” means the sum total of the floor areas contained in all the storeys of a building the measurements for which shall be taken from the external faces of the enclosing walls or limits of such building;

“plywood” means a material consisting of at least two plies (layers) of wood with the grain of adjacent plies at right angles to one another;

“population” means the capacity of the population in a building as set out in this Code;

“porcelain” means a high-grade ceramic ware characterised by high strength, a white colour, very low absorption, good translucency and a hard glaze;

“portico” means a roofed space, open or partly enclosed, which forms the entrance to a building;

“potable water” means water which is suitable for human consumption;

“premises” means a building or structure which is subject to formal approval or consent, for construction, alteration, change of use or demolition;

“pre-stressed concrete” means concrete in which effective internal stresses are induced artificially, usually by Means of tensioned steel, prior to loading the structure;

“product” means an item manufactured or processed for incorporation in the construction works;

“proscenium” means the stage frame in a theatre, fitted with curtains and a fire proof safety curtain to cut off the stage from the auditorium;

“protected shaft” means a staircase, escalator, chute, duct, or other shaft which enables persons, things or air to pass between different compartments;

“public building” means a building used, constructed or adapted to be used as a shop, office, hospital or used for purposes of public entertainment or public assembly;

“public sewer” means a sewer provided, constructed or maintained by or vested in a public authority;

“pumice” means a vesicular glass-formed froth on the surface of gaseous lavas whose highly porous structure makes it suitable as a lightweight aggregate for concrete;

“purlin” means a beam parallel to the eaves giving support to roof cladding;

“quantity surveyor” means a person who registered as a quantity surveyor in accordance with the Architects and Quantity Surveyors Act;



“rafter” means a sloping timber joist extending from the wall plate to the ridge of the roof, directly or indirectly supporting the roofing;

“railing” means a barrier consisting of a rail and supports;

“ramp” means an inclined way or floor joining two surfaces at different levels;

“range” means a number of like sanitary fixtures closely spaced and discharging to a common branch discharge pipe which does not receive the discharge from any other sanitary fixture in the range;

“reflux valve” means a non-return type of valve used in pipelines at rising gradients to prevent water which is ascending the gradient from flowing back in the event of a burst lower down;

“refuse chute” means a channel for transporting solid waste materials by chute from the point of disposal in a high-rise building;

“reinforced concrete” means concrete which contains reinforcement, normally of steel, to improve its resistance to tension, the materials of which are approved in accordance with this Code;

“reinforcement” means rods, bars, fabrics, wires or cables embedded in a material for resisting particular stresses;

“remedial works” means construction works that are undertaken to repair, strengthen or replace construction works that are defective or have deficient structural elements;

“rendering” means the application of mortar or plasterwork by means of a float or trowel;

“repair” means the making good of a defective part of a building not amounting to a reconstruction thereof;

“reservoir” means a pond or lake built for the storage of water, usually by the construction of a dam across a river; and includes subsurface accumulation of crude oil or natural gas under adequate trap conditions;

“residential building” means a building or part thereof designed or adapted or used for human habitation such as a detached, semi-detached or terraced house or a residential flat, and includes any outbuilding and other covered structure which is intended for the enjoyment of the occupiers of the building or part thereof or are otherwise appurtenant to a residential building as such;

“residential flat” means a separate dwelling used or constructed or adapted to be used wholly or partially for human habitation for a single family, where the kitchen, lavatory, bathroom or water-closet are contained within or separately from that dwelling, and which is contained in a building comprising of at least two of the dwellings joint vertically;

“retaining wall” means a wall providing lateral support to the ground or to resist pressure from a mass of other material but does not

include a soil nailed wall, reinforced earth wall crib wall or tied back wall;

“retaining wall” means a vertical or near vertical structure designed to retain soil or other material on one side in order to prevent collapsing or slipping;

“return wall” means an interior wall of about the same height as the outside wall of a building, distinct from a partition or a low wall;

“reverberation” means the continuation of an audible sound in an enclosed space after the sound source has been cut off;

“reverberation time” means the time taken for reverberant sound energy in an enclosure to decay to one millionth of its equilibrium value, that is, by 60dB, after the source is turned off;

“ridge” means an intersection at the top of two slopes in a pitched roof forming its apex;

“rising main” means a water main for supplying various floors;

“rod” means a solid rigid round section with a cross-section area small in relation to its length;

“rodding” means an operation of clearing a stoppage in a pipe by inserting a rod to break down item causing the stoppage and remove it or descaling of encrusted pipe-work with scrappers attached to jointed rods;

“rodding eye” means an access opening in a drainage installation provided for the purposes of gaining full bore access to the interior of a drain for internal cleaning, and which remains permanently accessible after completion of the installation, but does include an inspection chamber manhole;

“roof assembly” means a building cover and its supporting structure including any ceiling attached to such a structure;

“roof gutter” means a trough along the edge of the eaves of a building to carry off rainwater;

“roofing” means an upper layer or layers of a roof providing weatherproof surface;

“roof truss” means a frame intended to act as a beam to support a roof;

“safety glass” means glass containing thin wire reinforcement or laminated with transparent plastic or toughened by heat treatment to prevent splintering if the glass is broken;

“safety glazing” means a material which is in accordance with the requirements for the performance of safety;

“sand” means a loose material consisting of small mineral particles, distinguishable by the naked eye varying in diameter from 0.0625mm to 2mm and is angular or rounded;

“sanitary” means a space containing at least one water closet or urinals;

“sanitary appliance” means a fitting that is used for water supply and collection or discharge of either soil or waste water;

“sanitary group” means a combination of sanitary fixtures comprising not more than one of each of a water closet pan, bath, shower and sink and either two washbasins, or one washbasin and one bidet;

“scaffolding” means a temporary erection of timber or steelwork, used in the construction, alteration, or demolition of a building, to support or to allow for the hoisting, lowering or provide a working platform for materials or equipment;

“section” means a view of the parts contained in an intersecting surface usually a plane surface;

“self-closing” in relation to a door or fire-door shutter, means equipped device to ensure immediate closing of such a door, fire-door, shutter or fire-shutter after having been opened;

“separating element” means a wall or floor, which has a specific fire resistance that is used between divisions, occupancies or tenancies in a building;

“septic tank” means a tank used for the natural treatment of sewage;

“service pipe” means a pipe which is part of a water installation and which is connected to any communication pipe;

“sewage” means waste water, soil water, industrial effluent and other liquid waste, either separately or in combination, but does not include stormwater;

“sewer” means a pipe or conduit which is the property of or is vested in the county government and which is used or intended to be used for the conveyance of sewage;

“sewerage system” means a system for removal of surface water and foul water usually from beyond the cartilage of more than one construction site;

“shell” means a thin curved structural membrane without intermediate or integral support;

“shingle” means a thin, flat, rectangular piece of wood laid in the manner of a slate or tile, and arranged in overlapping rows for covering roofs and walls;

“short-lived material” means building material which is, in the absence of special care, liable to rapid deterioration or is otherwise unsuitable for use in the construction of a permanent building, hence it is used wholly or principally, for the construction of the weather resisting part of a roof or external wall of a building, and includes—

- (a) tongued and grooved boarding that is fixed horizontally, and a boarding that is at least 16mm in thickness, or in the case of a feather edge boarding, a boarding that is less than 16mm in thickness at the thicker edge of the board;
- (b) a sheet of fibre building board, except super hard-board, as defined in KS 2706-1 (Fibreboards - Specification Part 1: General requirements) and KS 2706-2 (Fibreboards - Specification Part 2: Requirements for dry process boards);
- (c) a wood-wool building slab;
- (d) plywood consistent with the requirements of KS 301-1 (Wood - Specification Part 1: Interior and exterior use), except plywood suitable for external use;
- (e) plaster board;
- (f) fibre plaster;
- (g) lime or gypsum plaster consistent with the requirements of KS 2647 (Gypsum plasterboard - Specification) on wood or metal lath;
- (h) cement plaster not exceeding 40mm in thickness on wood or metal lath;
- (i) sheet iron or steel which is not galvanized, painted or otherwise protected by a bituminous or other not less suitable coating;
- (j) organic-based felt;
- (k) canvas or cloth;
- (l) palm leaves thatch or matting;
- (m) unprotected softwood boarding, so far as it is used wholly or principally for the construction of the weather-resisting part of the roof of a building; and
- (n) any other combustible material.

“shutter” means a fusible link which melts in a fire permitting the door to close, and thus delays or prevents the spread of fire by confining it to one compartment;

“signboard” means a display which exceeds 0.5m<sup>2</sup> in area, and in the form of a notice or sign, which is printed, painted, carved, engraved or otherwise delineated on, or affixed to, a construction site and which is visible from a road or building, of—

- (a) the name, registered trade mark or nature of the trade, business or profession of a person;
- (b) the particulars of any occupation carried on at the place or premises;
- (c) the directions or cautions as are usual or necessary relating to the construction site or any commercial activity carried out on the construction site;

(d) the particulars or notification required or permitted to be displayed by written law; or

(e) of particulars relating to any service provided at the place or premises;

“sill” means a horizontal timber or stone, at the footing of an opening for a door, window or embrasure;

“single-stack system” means a one-pipe system in which trap vents are not required;

“site plan” means a plan used to locate the position of buildings in relation to setting out point, means of access, general layout of a construction site and which may also contain information on services drainage network;

“skirting” means a finishing board which covers the joint between the wall and the floor of a room;

“slate” means a fine-grained metamorphic rock formed from clay, shale or volcanic ash, by high pressure;

“sleeper” means a timber, steel, or precast concrete beam placed under rails to hold them at the correct gauge;

“sleeper wall” means a low load bearing wall to provide intermediate support suspended floor at ground level;

“slop-sink” means a sink intended for receiving solid or liquid filth;

“small house” means a single-storey or two-storeyed dwelling house of a capacity of less than 567m<sup>3</sup> but does not include a flat;

“smoke detector” means a photo electric system for an alarm when smoke in a room, chimney or other location exceeds a predetermined density;

“socket outlet” means a device with protected current transmitting contacts intended to be mounted in a fixed position and permanently connected to the fixed wiring of the installation to enable the connection to it of a flexible cord or cable by means of a plug;

“sod” means the surface of the ground with grass growing on it; or turf;

“soft landscape” means vegetation cover and includes ground cover”

“soil branch pipe” means a branch discharge pipe which conveys soil water;

“soil drain” means a drain which carries sewage or industrial effluent to the sewer, as opposed to storm drain;

“soil fixture” means a sanitary fixture which receives and discharges soil water;

“soil pipe” means a vertical cast iron or plastic pipe for carrying sewage from a building into the soil drain;

“soil water” means water containing excreted matter, whether human or animal;

“solid floor” means a floor comprising a concrete slab without voids or fillers;

“span” means a structural dimension measured between certain extremities or supports;

“spigot” means the plain end of a length of pipe which is fitted into an enlarged socket or ball at the beginning of the next pipe;

“spiral staircase” means a succession of tapered treads forming a curved staircase which extends as a single flight from one floor to another and which has a minimum radius of curvature of less than 100mm;

“spot level” means a reading taken to determine the level, in comparison with an ordinance datum or construction site datum;

“sprinkler system” means a fire protection system of pipes and outlets in a mine or other enclosure by delivering a fire extinguishing liquid or gas and sounding an alarm, usually automatically by the action of heat on the sprinkler head;

“stability” means the ability of an element or unit to resist breakdown or collapse;

“stack vent” means a ventilating pipe connecting to a discharge stack above the highest connected discharge pipe;

“staircase” means part of a building which provides a route of travel between different levels in such building and is formed by a single flight or by a combination of at least two flights and at least one intervening landing and includes newel posts, handrails and balustrades;

“stairwell” means a space reserved for accommodating a stair where the faces of the walls limit the volume;

“storage tank” means a tank, other than any tank used for storage of hot water or cistern serving a water closet pan or a urinal, which forms part of a water installation and is used for the storage of water;

“storey” means a part of a building which is situated—

- (a) between the top of any floor and the top of the floor next above it;
- (b) if there is no floor above another floor, between a floor and the mezzanine floor, open work floor, catwalk, gallery or ceiling above the floor; or
- (c) in relation to a building, the entrance to the building from the level of the adjoining ground;

“stormwater” means water resulting from natural precipitation or accumulation and includes rainwater, surface water, or subsoil water;

“stratum” means a part of land consisting of a space of any shape below, on or above the surface of the land or partly below and partly above the surface of the land, the dimensions of which are delineated;

“road” means a road lined with buildings including avenues, crescents, cul-de-sacs, alleys, closes, courts, places, lanes and drives;

“road boundary” in relation to a construction site, means the boundary which abuts any road;

“strip foundation” means a foundation that is excavated and cast in long lengths, used to carry longitudinal loads;

“structural” means relating to or forming part of any structural system;

“structural elements” means the parts or elements of a building which resist forces and moments and include foundations, beams, shear cores slabs, roof trusses, stairwells, load bearing walls and all other elements designed to resist forces and exclude doors, windows, and non-load bearing;

“structural system” in relation to a building, means the system of constructional elements and components of any building which is provided to resist the loads acting upon it and to transfer such loads to the ground upon which the foundation of the building rests;

“stub stack” means a straight 100 mm diameter discharge stack that does not exceed one storey high with a rodding eye at its top;

“stud” means a vertical member in the walls of a framed building to which wallboards, lathing, or panelling is nailed or fastened;

“subsoil” means the stratum of earth beneath the surface soil;

“subsoil water” means the ground water naturally contained in the subsoil;

“surcharge” means the load supported above the level of the top of a retaining wall;

“surface fire index” means a classification awarded to a combustible surfacing material that exceeds a thickness of 1mm when tested in accordance with the relevant standards developed under the Standards Act;

Cap. 496.

“surface of the wall” means part of the wall that excludes the surface of any door, window, window frame, fire-place, mantle shelf, fitted furniture or trim;

“suspended ceiling” means a ceiling hung at a distance from the floor or roof above;

“suspended floor” means the floor that spans between supports;

“switch” means a mechanical device for non-automatically making and breaking a circuit-carrying current not greatly in excess of the rated normal current;

“tapered tread” means a tread which has a greater width at one side than at the other and a going which changes at a constant rate throughout its length;

“temporary building” means a building that is so declared by the owner to be used for a specified purpose for a specified period of time as determined by the approving authority;

“tenement house” means a building in the domestic part of which any habitable room is intended or adapted for the use of at least two occupants;

“test hole” means a drill hole to obtain soil samples to determine their structural and physical characteristics;

“threshold” means a piece of stone, wood or metal that lies under an outside door;

“tie” means a structural member intended to resist tension;

“timber” means sawn or unsawn logs and all other forms of wood, including furniture, that is deposited for purposes of trade or manufacture, other than timber intended for use as firewood;

“timber yard” means premises that has an area exceeding 65m<sup>2</sup> where timber is stored or deposited for purposes of trade, manufacture or otherwise, including the storage of contractor’s timber work but does not include a contractor’s store on a construction site where timber is prepared and fabricated for use in the erection;

“trade effluent” means a liquid, either with or without particles of matter in suspension, which is wholly or in part produced in the course of any trade, industry or research, but does not include soil water or waste water;

“transom” means a horizontal member across an opening or frame of a window or door;

“trap” means a plumbing fitting that holds water to prevent air, gas, and vermin from backing up into a fixture;

“trap vent” means a ventilating pipe connecting an individual trap to the open air or to another ventilating pipe;

“travel distance” in relation to any point, means the distance to be covered between that point and the nearest protected doorway measured from where the floor is divided by fixed seating or any other obstruction, by way of the shortest route along an open gangway; or where the floor is not divided, by way of the shortest route;

“tread” means the upper surface of a step;

“trim” means the edging of an opening in a colour or material different from that of the wall surface and which covers open joints;

“trunk sewer” means a sewer receiving sewage from many tributaries serving a large territory;

“truss” means a frame generally of steel, built from members in tension and compression;



“tunnel” means a long narrow horizontal or near horizontal underground passage that is open to the atmosphere at both ends, used for aqueducts and sewers, carrying railroad and vehicular traffic, various underground installations, and mining;

“two-pipe system” means a system of piping between sanitary fixtures and a drain in which waste water and soil water discharge through separate discharge pipes and in which any trap venting or other venting that is required is via separate ventilating pipes for the waste and soil water systems;

“underpinning” means an introduction of support under an existing structure;

“unprotected steel” means structural steel which is not protected with fire resistant material against the effect of fire;

“unsuitable surrounding” means an area without access to fresh air despite being free from pollution or any other environmental or health hazards;

“utility room” means a room designed to or likely to be used to contain clothes washing and equipment such as a sink, washing machine, tumble drier or another feature or equipment which may reasonably be expected to produce water vapour in significant quantities; and includes a room that is used for storage, within the roof space of building;

“valley” means a meeting line of two slopes in a pitched roof forming a re-entrant angle;

“valve” means a device to control flow of fluid;

“vent stack” means a main vertical ventilating pipe of any part of a drainage installation;

“vent valve” means a one-way air valve specifically designed and constructed to be fitted near the crown of the trap serving a waste fixture to protect the water seal of such trap against excessive negative air pressure arising in the fixture discharge;

“ventilating pipe” means a pipe which leads to the open air at its highest point and which provides ventilation for the purpose of preventing the destruction of water seals, but does not include a discharge pipe;

“ventilation” means a provision for the movement, circulation and quality control of air in an enclosed space; and the process of supplying or removing air to or from a building or part thereof by mechanical means or devices;

“ventilator” means a device with an adjustable aperture for regulating the flow of fresh or stagnant air and includes a mechanical apparatus for producing a current of air as a blowing or exhaust fan;

“veranda” means an open portico or roofed gallery extending along the front and occasionally, other sides of a dwelling or other building, erected chiefly as a protection or shelter from the sun or rain;

“verge” means a projecting sloping edge of a pitched roof that portion of the surface of finished pavement earthworks not covered by the carriage way or footpath;

“vermiculite” means a generic name for hydrous silicates of aluminium, magnesium and iron, which occurs as a mineral in a plate form, and shows marked exfoliation on heating which is used for thermal insulation and fire protection, often as an aggregate in plaster or concrete;

“vestibule” means a hall or chamber between the outer door and the interior rooms, of a building;

“volatile matter” means organic chemicals that vaporise when they are at room temperature;

“wall” means each of the portions between a vertical load or non-load carrying building element that serves to demarcate or enclose a space;

“wall plate” means a structural member along the top of a wall or built into its length, that distributes the forces from joists, rafters or roof trusses;

“waste appliance” means a sanitary appliance for the collection and discharge of water used for ablutionary, culinary or other domestic purposes;

“waste branch” means a branch discharge pipe which conveys waste water only;

“waste pipe” means a pipe which receives the waste from appliances such as baths, sinks (not being slop-sinks), bidets, or lavatory basins;

“waste stack” means a waste pipe which receives the waste from at least two appliances such as baths, sinks (not being slop-sinks), bidets, or lavatory basins fixed in at least one storey of a building;

“water fitting” means a component, other than a pipe of any water installation, through which water passes or in which it is stored;

“water installation” means an installation used or intended to be used for the conveyance or storage of water in any building or on any construction site on which such building is situated and includes any pipe or any water fitting other than any water meter vested in the local authority;

“water seal” means the water in a trap which acts as a barrier against the flow of any foul air or gas;

“water supply system” means a system of structures, aqueducts, pipes, valves, pumps, meters or other appurtenances relating thereto which are vested in the county government and are used or intended to be used by it in connection with the supply of water;

“water works” means the whole system of supply and treatment utilized in acquisition and distribution of water to consumers;

“wearing course” means the topmost layer of material laid down in the construction of a road that deteriorates due to material removal caused by relative motion between it and another part;

“weep hole” means a hole in a wood sill, retaining wall or other structure to allow accumulated water to escape;

“weld” means a technique for joining of pieces of metals in which actual melting of the pieces to be joined occurs in the vicinity of the bond;

“wind load” means a load due to the effect of wind pressure or suction;

“winder” means a tapered tread that has a minimum going of less than 50mm and which is used in conjunction with non- tapered treads in a single flight;

“wired glass” means annealed glass containing a wire mesh which is completely embedded in the body of the glass during manufacture;

“wood wool slab” means a slab made from long wood shavings with a cementing material; and

“zone of space” means the volume of open air outside an opening relating to an external wall or a portion of such an opening.

3. The purpose of this Code is to promote order and safety in construction works, and the health and safety of persons in or about construction works.

Purpose of Code.

4. (1) The scope of this Code is to provide—

Scope of Code.

- (a) standards for the design, construction, operation, inspection and maintenance of a building;
- (b) standards for design, building materials, products, elements, systems and building services;
- (c) standards for infrastructure services;
- (d) standards for the operations and works at a construction site;
- (e) standards for disaster management at a construction site; and
- (f) standards for the safety and security of the users and occupants of a building.

(2) This Code shall not apply to the construction and maintenance of a single storey residential building which is occupied by the owner and is constructed of locally available materials whose design is influenced by the culture and traditions of the area where the building is sited.

5. (1) A person who engages in construction works, or a person who owns or occupies a building shall comply with this Code.

Compliance with applicable laws.

(2) A person who intends to undertake any construction works shall obtain—

- (a) a development permission in accordance with the Physical and Land Use Planning Act, 2019; No. 13 of 2019.
- (b) an environmental impact assessment licence issued in accordance with the Environmental Management and Coordination Act, 1999; No. 8 of 1999.
- (c) a compliance certificate issued in accordance with the Act; and
- (d) any other applicable approval.

6. (1) The preparation of the design and supervision of the works in a building shall only be undertaken by a professional in the respective fields of specialisation. Supervision of construction works.

(2) A professional under sub-paragraph (1) includes a physical planner, architect, engineer, land surveyor, building surveyor, quantity surveyor, accredited site supervisor and accredited skilled worker, duly registered under the relevant law.

#### PART II—SITING AND SPACE ABOUT BUILDINGS

7. (1) An owner engaging in construction works shall comply with the conditions as may be imposed by the approving authority regarding the siting, size, height, shape and appearance of the building to safeguard, maintain or impose the dignity or preserve the amenity and general appearance of a road, square, public place. Compliance to basic physical planning requirements.

(2) A building, an out-building, latrine and all drain and sanitary apparatus of any kind pertaining to the building, shall be situated on the construction site so as to—

- (a) ensure hygienic and sanitary conditions; and
- (b) avoid, as much as possible, any form of nuisance from the position of the latrines or buildings.

(3) Where a building may be situated so as to form a terminal feature to a road or which may otherwise be prominently displayed, the owner shall—

- (a) situate the building in the approved position; and
- (b) comply with the conditions imposed by the approving authority.

8. An owner shall not erect a building on a construction site which has been— Siting of building.

- (a) made up or filled up by offensive or unsanitary materials;
- (b) used for the deposit of filthy or offensive matter, unless the filthy or offensive matter has been removed, and the construction site has been remedied; or
- (c) zoned as being prone to hazardous substances unless consideration has been made in compliance with Kenya wind speeds, Kenya seismic zoning and local flood maps.

9. (1) An owner shall construct at least one access of the construction site to a road. Access to construction site.

(2) Where access to a construction site requires the crossing of an open space, a culvert constructed in accordance with KS 548 (Specification for precast concrete pipes and fittings for drainage, sewerage and culverts) shall be provided for the full width of the entrance or for a length of 4m, whichever is the greater.

(3) An owner may construct a temporary culvert for the period of the construction of a building for purposes of the flow of the drain.

(4) An owner shall ensure that every access road allows for an accelerating and decelerating lane at the junction of the access road with another road.

10. (1) The design of a frontage shall be as provided for under this Code. Frontage.

(2) An owner shall develop and maintain the frontage of the building.

(3) A building shall not have a frontage abutting on to a road of a width of less than 10m.

(4) An owner shall not erect a building on a construction site with a frontage to a road that is a sanitary lane or passage.

(5) An owner shall not erect a building whose principal access or frontage abuts to a service lane, alley or passage.

(6) A means of access from a service lane for use by the public, in any premises, shall not be permitted to be used for retail trade coverage.

11. An owner shall ensure that—

Service area.

(a) an open area is left on each construction site for purposes of servicing a building thereon; and

(b) the means of access to the area is of the approved dimensions.

12. (1) An owner shall provide a boundary wall, screen wall, fence, vegetative fence or other means of an enclosure. Means of enclosure of building.

(2) Sub-paragraph (1) does not apply to an enclosure of a residential building whose height does not exceed 1.35m.

(3) An owner may increase the height of the enclosure referred to in sub-paragraph (2) to a height that does not exceed 2.4m.

(4) In erecting an enclosure for a residential building, an owner shall not use a razor wire, except at a height of at least 2m above ground level.

(5) If an owner uses electric fencing, it shall be installed in accordance with—

(a) KS 2112-1 (Electrical security installations - Part 1: General);

- (b) KS 2112-2-1 (Electrical security installations - Part 2-1: Access control systems - General characteristics);
- (c) KS 2112-2-2 (Electrical security installations - Part 2-2: Access control systems - Central processor);
- (d) KS 2112-2-3 (Electrical security installations - Part 2-3: Access control systems - Card readers);
- (e) KS 2112-2-4 (Electrical security installations - Part 2-4: Access control systems - readers controllers);
- (f) KS 2112-2-5 (Electrical security installations - Part 2-5: Access control systems - Biometric readers);
- (g) KS 2112-2-6 (Electrical security installations - Part 2-6: Access control systems - Access cards);
- (h) KS 2112-2-7 (Electrical security installations - Part 2-7: Access control systems - Barriers);
- (i) KS 2112-2 (Electrical security installations - Part 2: Access control); or
- (j) KS 2112-3 (Electrical security installations - Part 3: Electrical security fences (non-lethal)).

13. The formation, laying out, material widening of a means of access or an erection, shall not be constructed so as to obstruct the view of a person using a road used by vehicular traffic, at or near a bend, corner, junction or intersection in a manner that is likely to cause danger to the person.

Obstruction of view.

14. (1) A construction site on which a residential building is constructed shall have an open space at the rear, or partly rear and at the side, of the building.

Space around residential building.

(2) Subject to paragraph 166 (1) (e), a part of a building shall not be erected within 1.5m of the rear boundary and at least 1.5m from the side boundary which space shall be counted as part of the open space referred to in sub-paragraph (1).

(3) Subject to paragraph 166 (1) (e), the open space referred to in sub-paragraph (1) shall be such that no building bounds the open space at a level that is less than 2.4m in height from the ground of the open space.

(4) A residential building that bounds the open space referred to in sub-paragraph (1) shall have a level of at least 150mm at the floor of the lowest storey.

(5) An existing residential building which has an open space of equal or less area than that required by this paragraph, shall not be altered in such a manner as to reduce the open space.

(6) An existing residential building which has a greater area of open space than that required by this paragraph, shall not be altered in such a manner as to reduce the area of the open space to less than that required under this paragraph.

(7) Where an open space is at a level that exceeds 600mm below the level of an adjoining open space, safe parapet walls, railings or fences, shall be provided by the owners of the adjacent open spaces.

(8) Access shall be provided to every open space.

15. (1) In addition to an open space required under paragraph 14, a residential building shall have a service lane at the rear or side of the building. Service lane.

(2) A service lane may not be required—

- (a) where a public lane that is at least 3m wide, or a road already exists;
- (b) for a detached or semi-detached building; and
- (c) where exempted by the approving authority.

(3) A service lane shall be accessible from an existing road but where the access is not possible, this paragraph shall be considered to have been complied with if access would be obtained in the event of future development or redevelopment of other construction sites within the area.

(4) The alignment, width and levels of a service lane shall be determined by the approving authority who may grant a modification if a lane exceeding 1.5m in width is required.

16. Where the width of an existing road in front of a new building is less than 6m, a part of the building shall be within 6m from the centre line of the road. New building on existing road.

17. (1) The protection of the edge of any balcony, bridge, flat roof or similar place shall be designed to prevent any person from falling from the balcony, bridge, flat roof or similar place. Protection edge above ground floor.

(2) The edge of any balcony, bridge, flat roof or similar place, that is more than 1m above the adjacent ground or floor level, shall have a balustrade or parapet wall, that is at least 1m in height, unless access by persons thereto has been excluded by a physical barrier.

(3) Where a building has an interior balcony, or a mezzanine floor, the balcony or mezzanine floor shall have a balustrade or wall of a height of at least 1m.

(4) Where a balcony or mezzanine floor is used for public seating in rows, the height referred to in sub-paragraph (3) may be reduced to at least 800mm opposite the seating in the front row.

(5) A balustrade or wall that is provided as a protective edge at a change in level in an occupancy classified as E2, E3, H1, H2 or H3 specified in Table 1 set out in the First Schedule, shall not have any opening that permits the passage of a 100mm diameter ball.

(6) The protective edge of an occupancy, not being an occupancy classified as E2, E3, H1, H2 or H4 specified in Table 1 set out in the First Schedule, shall consist of at least a handrail and one other rail midway between the handrail and the floor.

18. (1) A residential building shall be situated so as to leave an open space immediately in front thereof which extends along the whole width of the front of the building and is at least 6m wide measured at right angles from the building.

Space in front of building.

(2) If a building fronts a road whose width does not exceed 6m, the width of the open space in front of the building shall be at least the sum of the width of the road and half of the difference between the actual width of the road and 6m.

(3) Any part of the open space which lies within the construction site, shall be free from any building thereon above the level of the ground, except a fence, wall or gate, which does not exceed a height of 1.35m, or a portico, porch, staircase or similar projection, from the building.

19. (1) A building which is designed, either wholly or in part, for residential purposes, shall be provided, on at least one side, with an open space of at least 1.5m in width, measured from the boundary of the nearest construction site facing that side, at right angles, to the nearest point of the building.

Side space.

(2) The open space referred to in sub-paragraph (1) shall extend along the entire length of the building for a width of 1.5m and a height of 2.4m.

20. Where a building contains more than one dwelling, and is designed to have an internal courtyard or open space, there shall be in the courtyard or open space, an area free from obstruction of at least 35m<sup>2</sup> which has a dimension of at least 4.5m.

Measurement of courtyard.

21. (1) Except a residential building which does not exceed five storeys in height, every building shall have a secondary means of access.

Means of access.

(2) A residential building shall have an independent access to a road where the road is not a sanitary lane or passage.

(3) A dwelling unit contained in a block of flats, or separate offices and occupancies within a building, shall have a common access to the road.

(4) Every building shall be accessible from a road.

(5) A person erecting a building shall provide a service area for the building and the means of the access to the service area shall be of a width of at least 3m.

22. A passage between buildings erected on the same construction site, or between a building and the boundaries of the construction site, shall have a width of at least 1.2m and a height of at least 2.4m.

External passage.

23. (1) An eave, cornice, moulding or another architectural projection shall not project over a road for more than 500mm, or at a height below 2.4m above the level of the ground.

Eave, cornice or moulding.



(2) A pipe (including a water-pipe or a drain-pipe), gutter, or the appurtenances of a pipe or gutter, shall not project over a road for more than 300mm or at a height below 2.4m above the level of the ground.

24. (1) A canopy erected within 600mm of the outer edge of a footpath, or projecting over a road, shall have a clear space of at least 5.5m beneath every part thereof.

Balcony or canopy over road.

(2) A canopy erected over a footpath shall have a clear space of at least 3.3m beneath every part thereof.

(3) A canopy shall have a drainage pipe that shall have a diameter of at least 50mm.

(4) The maximum projection of a canopy (including a cornice, moulding or another feature) erected over a road shall be a tenth of the width of the road or 3m, whichever is less.

(5) A portion of a canopy shall not be within 4.5m measured horizontally, of a line drawn vertically from a point in the centre line of the road nearest to the portion of the canopy.

(6) Where it is considered desirable that a canopy be erected in front of a new building, the owner shall provide, in the design of the building, for the canopy and the structures that shall conform to the conditions or design and materials recommended by the engineer.

(7) The owner of a building shall construct a canopy which projects over a road in such a manner that the activities below the canopy does not interfere with the movement of pedestrians.

25. The external wall of a building shall not have a door that gives direct access to the top of a canopy.

No door on to canopy.

26. Where a veranda or balcony has been built over or upon a road, the veranda or balcony shall not be used, or adapted to be used, as a factory, workshop, storeroom, kitchen, lavatory, bathroom, water-closet, urinal or latrine, restaurant or any other activity that interferes with pedestrian movement.

Use of veranda or balcony.

27. (1) Subject to sub-paragraph (2), a gate or opening, on or over a road, shall be located in such a manner that the gate or opening does not project over the road at a height below 2.4m above the ground.

Door, window and gate not to open over road.

(2) A door to an emergency exit, electrical transformer room, plant room, refuse storage chamber or leading to a similar type of utility room, or chamber, may open outwards over a road if the door, when fully opened, does not cause an obstruction to a person or vehicle using the road.

(3) Where a revolving door or turnstile is used, an alternative means of exit shall be provided in close proximity.

(4) Turnstiles, if used, shall not be installed in an emergency exit.

28. (1) A tenement house may be constructed with a depth—

Tenement house.

(a) from the front main wall to the nearest rear main wall; or

- (b) from the front of a balcony is projecting from the front main wall to the nearest rear main wall,

that does not exceed 10m.

(2) A storey of a tenement house shall have a window in the rear main wall of the storey.

(3) The window referred to in sub-paragraph (2) shall be so constructed that—

- (a) the aggregate superficial area of the glass in the window is at least 1.5m<sup>2</sup>; and
- (b) the window can, to an extent of at least 1.5m<sup>2</sup>, be opened into the open air in such a manner that the top of the opening is at least 2m above the level of the floor.

(4) A window in a tenement house shall not be obstructed by the erection of a structure either inside or outside the building.

(5) The internal area of every kitchen in a tenement house shall be—

- (a) at least 3.75m<sup>2</sup>, where the total area of the domestic premises which the kitchen forms part of, does not exceed 45m<sup>2</sup>;
- (b) at least 4.5m<sup>2</sup>, where the total area of the domestic premises which the kitchen forms part of, exceeds 45m<sup>2</sup> but does not exceed 70m<sup>2</sup>;
- (c) at least 5.5m<sup>2</sup>, where the total area of the domestic premises which the kitchen forms part of, exceeds 70m<sup>2</sup>; and
- (d) the smaller dimension of the kitchen shall be at least 1.5m.

29. (1) A place used, or adapted to be used, as storage for combustible construction materials which is situated within 15m of any building, shall be enclosed on all sides for a height of at least 2m by—

Enclosure and storage for combustible material.

- (a) a fence constructed of incombustible material;
- (b) a brick wall or a wall constructed of building blocks made of cement mortar—
- (i) of at least 100mm in thickness; and
- (ii) provided with buttresses or piers, of at least 215mm<sup>2</sup> in the horizontal section at all ends and angles of the walls and not more than 3m metres apart, centre to centre;
- (c) a concrete wall of at least 150mm in thickness; or
- (d) a wall or a fence made of any other approved material.

(2) A storage for combustible construction materials shall not be built within 2m of the boundary.

(3) The space referred to in sub-paragraph (2) shall not be used for storage or be obstructed by the erection of any structure.

(4) A pile, stack or store of combustible construction material shall not—

- (a) exceed a height of 5m; and
- (b) be formed to provide any room or other space to be used for habitation, or any other purpose except access and ventilation.

30. A place used, or adapted to be used, as a timber yard, which is within 15m of a building, shall be enclosed on all sides for a height of at least 2m by—

Enclosure for timber yard.

- (a) a fence constructed of incombustible materials; or
- (b) a brick wall or a wall constructed of building blocks made of cement mortar—
  - (i) of a thickness of at least 100mm; and
  - (ii) provided with buttresses or piers of at least 215mm<sup>2</sup> in the horizontal section at all ends and angles of the walls and not more than 3m apart, centre to centre; or
- (c) a concrete wall which is not less than 150mm in thickness.

31. (1) A temporary building may be constructed of short-lived material.

Temporary building.

- (2) A temporary building shall not be erected within 3m of—
  - (a) another building; or
  - (b) the boundary.
- (3) The space referred to in sub-paragraph (2) shall be kept clear.

32. (1) An owner of a building shall erect a hoarding, covered walkway or gantry, prior to the commencement of the construction works, and shall maintain the hoarding, covered walkway or gantry in good repair during the continuance of the development permission.

Maintenance of hoarding, covered walkway or gantry.

(2) Except on isolated construction sites, a hoarding shall be close boarded.

(3) A hoarding, covered walkway or gantry, shall not be constructed so as to obstruct any drainage channel.

33. A building or a fixture shall be constructed in such a manner that it does not—

Building not to obstruct, endanger or cause nuisance.

- (a) obstruct a neighbouring parcel of land or a public open space;
- (b) endanger the users of any adjacent footpath or road;
- (c) create a nuisance; or
- (d) permit the escape into, or over, an adjacent footpath or road, at a height below 2.4m, of a noxious gas or exhaust, from a ventilating system.

34. A building shall not be erected in such a manner that it reduces the quantity of light and ventilation to another building, which has been erected in accordance with this Code.

Light and ventilation not to be diminished.

### PART III—PARKING SPACES

35. An owner of a commercial building shall provide the minimum parking spaces specified in Table 2 set out in the First Schedule.

Parking requirements.

36. Vehicular circulation shall take into account vehicular types, types of garages access ramps, barrier control types, columns guard types and signage.

Vehicular circulation.

37. (1) Basic garage dimensions shall be as specified in the Figure 1 set out in the Second Schedule.

Garage dimensions.

(2) Minimum dimensions for garages shall be as specified in Figure 2 set out in the Second Schedule.

(3) Turning circles or vehicular circulation shall be as specified in the Figure 3 set out in the Second Schedule.

38. (1) An owner of a commercial building or multi-dwelling unit shall designate at least 5% of the parking spaces for charging electric vehicles.

Charging port for electric vehicle.

(2) The parking spaces referred to in sub-paragraph (1) shall be clearly marked and be equipped with charging infrastructure installed in accordance with IEC 62196 (Plugs, sockets-outlets, vehicle connectors and vehicle inlets – conductive charging of electric vehicles).

39. (1) A pedestrian guarding shall be provided where it is necessary to guard the edges of any part of—

Pedestrian guarding.

- (a) a floor;
- (b) a window that opens outwards;
- (c) a gallery;
- (d) a balcony;
- (e) a roof;
- (f) any other place to which people have access, unless it is only for the purpose of maintenance or repair; and
- (g) a light well, basement area or a sunken area next to a building.

(2) A guardrail shall be provided in a vehicle parking area, but not on a ramp used only for vehicle access.

(3) A guardrail need not be provided in the places used as loading bays where it would obstruct the usual use of the place.

40. (1) Any wall, parapet, balustrade or similar obstruction may serve as a guardrail.

Design of guarding.

- (2) A guarding shall be—
- (a) of at least the height specified in Figure 4 set out in the Second Schedule; and
  - (b) resist, at a minimum, the horizontal force specified in Figure 4 applied at the height shown.

41. (1) If a vehicle has access to a floor, roof or ramp which forms part of a building, a barrier shall be provided on an edge which is level with, or above the floor or ground, or another route for vehicles to a height of between 375mm and 610mm above the ground.

Vehicle barrier.

(2) A wall, parapet, balustrade or similar obstruction may serve as a vehicle barrier.

(3) Every vehicle barrier shall resist the forces set out in KS EN 1991 (Actions on Structures).

42. Where a vehicle ramp or driveway is constructed in a building which is not classified as H4 specified in Table 1 set out in the First Schedule, or on a construction site, —

Vehicle ramp or driveway.

- (a) the vehicle ramp or driveway shall have a gradient that does not exceed 1 in 25 within a distance of 5m from a road which is crossed by the ramp or driveway;
- (b) the ramp used by pedestrians shall have a gradient that does not exceed 1 in 12; and
- (c) the ramp designed for use by both vehicles and pedestrians shall have a walkway that is at least 1.2m wide and a kerb that is at least 150mm high.

43. (1) To permit safe passage, the steepest slope of a pedestrian ramp shall have a gradient of 1 in 12.

Pedestrian ramp.

(2) A pedestrian ramp or landing shall have clear headroom of at least 2.1m.

(3) A pedestrian ramp shall at all times be clear of permanent obstructions.

(4) The width of a pedestrian ramp which forms a means of escape shall be designed in accordance with Part XXI, while ramps which provide access for persons living with disabilities shall be designed in accordance with Part XX.

(5) The handrails on a pedestrian ramp shall be installed in accordance with KS ISO 21542 (Building construction - Accessibility and usability of the built environment).

- (6) A handrail shall—
- (a) be at a height of between 850mm and 1000mm;
  - (b) shall give firm support;
  - (c) allow a firm grip; and

(d) form the top of the guardrail.

(7) A pedestrian ramp shall have a landing after every 9m of travel distance.

(8) A pedestrian ramp and its landing shall be provided with a guarding in the same manner as a staircase.

44. An access ramp shall have—

Access ramp.

(a) a maximum slope of 12.5%;

(b) for one-way directional traffic, a width of at least 3m; and

(c) for two-way directional traffic, a width of at least 6m.

45. The design for a ramp on a sharp curve in accessing a shopping centre loading dock and maximum gradients, shall be 10% on a straight and 7% on an inner kerb.

Maximum curved gradient.

46. Parking spaces shall be provided as follows—

Parking spaces.

(a) for housing—

(i) for residents, 1 parking space off the road; and

(ii) for visitors, 1 parking space off the road;

(b) for shopping—

(i) for staff, 1 parking space for each 50m<sup>2</sup> of gross floor area; and

(ii) for customers, one parking space for each 35m<sup>2</sup> of gross floor area;

(c) for large lorries or buses, 5m x 15m as specified in Table 3 set out in the First Schedule and Figure 5 set out in the Second Schedule.

#### PART IV—PREPARATION OF CONSTRUCTION SITES

47. (1) Before the erection, alteration, scaffolding or demolition of a building, an owner shall install a boundary to prevent the public from entering the construction site and to protect the public from the activities on the construction site.

Protection of construction site.

(2) The boundary install under sub-paragraph (1) shall be retained for as long as is necessary and maintained by the owner in a safe condition and any access to the construction site shall be subject to approval of the owner.

(3) No part of a boundary shall be removed until the construction works have been completed.

(4) A person who undertakes an erection or demolition on a construction site shall—

(a) confine all operations in connection with the erection or demolition within the boundaries of the construction site; and

(b) not encroach upon or over any road or public place abutting the construction site.

(5) An owner shall indemnify the approving authority against any expenses, loss, claims or suits arising out of or in connection with the boundary.

48. (1) Where any work connected with the demolition or erection of any building is likely to cause or have any detrimental effect on the strength, standard, safety, quality or position of any public facility or utility owner shall pay a deposit or give security to the approving authority, to cover any costs of the repair or any damage which may be caused by the work.

Damage to public facility or utility.

(2) In the event of damage to a public facility or utility, the approving authority may appropriate the amount of the deposit or security referred to in sub-paragraph (1), towards the costs of repairing the damage.

(3) If the amount of the deposit or security referred to in sub-paragraph (1) exceeds the costs of repairing the damage, the surplus shall be refunded to the owner, and if such costs exceed the amount of the deposit or security issued by the owner, the owner shall be liable to the approving authority for the deficit.

(4) In the event of damage to a public facility or utility, where the deposit or security referred to in sub-paragraph (1) has not been lodged, and the approving authority repairs the damage, the owner shall pay the cost of repairing the damage to the approving authority on demand, failing which the approving authority shall repair the damage at the cost of the owner.

49. (1) The approving authority shall inform the owner where there is reason to believe that there may be unstable soil or an unstable slope in the area or on a construction site upon which a building is to be erected or is situated.

Unstable soil or slope.

(2) Where the owner is informed under sub-paragraph (1), and if any unstable soil or unstable slope is evident within the construction site, the owner shall submit to the approving authority a statement prepared by an engineer specifying the measures necessary to provide for any differential movements or other effects on the construction site referred to in sub-paragraph (1), which may be detrimental to the building.

50. (1) Before a foundation is laid, the space intended to be occupied by the building shall be cleared of vegetation, tree stumps, timber or other cellulose material, debris or refuse or any material contaminated with faecal matter.

Preparation of construction site.

(2) Where a construction site upon which a building is to be erected is waterlogged or saturated, or water naturally drains into the space intended to be occupied by a building, a drainage shall be provided to direct the water away from the construction site, space or building, to a storm water drain or to dispose of it in another safe approved manner.

(3) Site grading shall be carried out in accordance with a landscaping plan developed by an architect in liaison with an engineer.

51. The soil in a construction site defined as in KS ISO 11074 (Soil quality vocabulary) shall be treated in accordance with the recommendations of KS 999 (Methods of tests for soils for civil engineering purposes). Quality of soil.
52. (1) Where excavation work is in progress, or a building is being erected or demolished, the owner shall take precautions in relation to the working area, on the surrounding roads and footways, to limit to a reasonable level the amount of dust arising from the construction works in accordance with the Environmental Management and Coordination (Air Quality) Regulations, 2014. Control of dust and noise.  
L. N. 34/2014.
- (2) During the periods specified in sub-paragraph (3), an owner shall not carry on an activity, or use or permit to be used in the course of any construction works, a machine, machinery, engine, apparatus, or tool, which may unreasonably disturb or interfere with the amenity of the neighbourhood.
- (3) The periods referred to in sub-paragraph (2) are—
- (a) national public holidays and Sundays;
  - (b) before six o'clock in the morning and after five o'clock in the evening on Saturday; and
  - (c) before six o'clock in the morning and after six o'clock in the evening on a day other than the days stated in sub-paragraph (3) (a) and (b).
- (4) The prohibition in sub-paragraph (2) shall not apply in a circumstance where the use of a machine, machinery, engine, apparatus, or tool—
- (a) is necessary in order to preserve the life, safety or health of a person;
  - (b) is necessary to preserve property; or
  - (c) has been authorised in particular cases by the approving authority.
53. (1) Where the approving authority considers that the construction works are not in accordance with this Code, it may order an investigation, and may by notice in writing, order the owner of the building to— Cutting into, laying open or demolishing construction works.
- (a) provide proof that the construction works are in accordance with this Code, to the satisfaction of the approving authority;
  - (b) cause a test of the construction works to be carried out within the time, to the extent and by the person specified in the notice; or
  - (c) cause the construction works to be cut into, laid open or demolished to the extent required by the approving authority.
- (2) Where the approving authority issues an order under sub-paragraph (1) (b), the owner shall submit a written report with regard to the test to the approving authority.



(3) The report referred to in sub-paragraph (2) shall be signed by the person who carried out the test and shall contain details relating to—

- (a) the testing apparatus, methods and materials used in the test;
- (b) the conditions under which the test was carried out; and
- (c) the results obtained during the test and at the conclusion thereof.

(4) Where after receipt of the report under sub-paragraph (2), the approving authority is not satisfied that the construction works concerned are in compliance with this Code, the approving authority may, by notice served on the owner—

- (a) order the owner to take the necessary measures within the period stated in the notice to ensure compliance; or
- (b) cause the construction works to be cut into, laid open or demolished.

(5) An owner who has been ordered to cause construction works to be cut into, laid open, demolished or tested, under this paragraph, shall not continue with any other work affected unless authorised by the approving authority.

(6) Where a cutting into laying open, demolishing or testing reveals a contravention of this Code, or of any approval granted, or if the necessity for the cutting into, laying open, demolishing or testing is attributable wholly or partly to a contravention of this Code, the cost of the works shall be borne by the owner.

54. Where excessive rubble, rubbish, other debris or combustible waste material accumulates on a construction site before or during construction works, the approving authority may, by written notice, order the owner of the site to have the rubble, rubbish, other debris or combustible waste material removed within the period specified in the notice.

Waste material on construction site.

55. (1) An owner engaging in construction works shall remove surplus material or unused matter resulting from the construction works, from the construction site and from any other construction site or public space, during or after the completion of the construction works.

Cleaning of construction site.

(2) If an owner fails to clean up a construction site after completing construction works, the approving authority may, by written notice, order the owner to have the surplus material and matter removed within a period specified in the notice.

56. (1) A person engaging in construction works, shall construct a temporary contractor's shed on the construction site.

Contractors' shed.

(2) A contractor's shed shall only be used for a purpose connected with the construction works.

(3) Where a contractor's shed is erected near a live wire, the owner shall ensure that the live wire is rendered safe in accordance with KS 662 (Electrical installations).

(4) On completion or cessation of the construction works, or where a contractor's shed is no longer necessary for the purpose for which it was erected, the contractor's shed shall be removed from the construction site by the owner.

(5) Security personnel employed on the construction site may be accommodated in a contractor's shed, subject to fulfilling the requirements and conditions as may be necessary for safeguarding public health and the health of the personnel and for avoiding nuisance or inconvenience to persons in the vicinity of the building.

57. (1) An owner carrying out construction works shall provide—

Facilities at construction site.

- (a) sanitary facilities for the use of the personnel on the construction site;
- (b) for the disposal of drainage into a public drain, or sewer where a drain or sewer exists on or near a construction site; and
- (c) changing rooms for the use of the construction workers on the construction site.

(2) An owner shall not engage in construction works without providing sanitary facilities for all personnel employed on or in connection with the construction works.

(3) Where the sanitary facilities have not been provided in accordance with sub-paragraph (2), the approving authority shall direct the suspension of the construction works until the required facilities are made available.

(4) Sanitary facilities shall be situated in a manner that is not offensive and shall at all times be maintained in a clean and hygienic condition.

(5) Unless the sanitary facility is of a permanent nature, the owner shall remove the facility immediately the construction works have been completed.

(6) Sanitary facilities shall be provided—

- (a) at the rate of not less than one sanitary facility for every thirty persons; and
- (b) separately for each of the different sexes.

#### PART V—BUILDING MATERIALS

58. (1) A person shall not use or permit to be used, in any construction works, any material which is not—

Building materials.

- (a) of a suitable nature and quality for the purpose for which it is used;

- (b) adequately mixed or prepared for the functions for which it is designed; or
- (c) applied, used or fixed in such a manner as to adequately perform the functions for which it was designed.

(2) The use of any type of material, any method of mixing, preparing materials, applying, using or fixing materials, shall conform to the standards and codes of practice developed under the Standards Act.

Cap. 496

(3) Compliance with this paragraph shall be deemed sufficient where—

- (a) in the event of more than one standard having been issued, the type of material or method used conforms with the latest edition of the standard or code and any published amendments; and
- (b) the use of that type of material or method is appropriate for the purpose and conditions for which it is used.

59. Used material shall only be used on construction works if the material meets the performance requirements of the corresponding relevant standard issued under the Standards Act.

Used material.

Cap. 496.

#### PART VI—STRUCTURAL DESIGN

60. (1) Every building, structural element or component of a building and an incidental structure shall be designed to be safe and serviceable.

Structural design requirements.

(2) A design of a building shall provide adequate structural resistance, serviceability, durability and reliability.

(3) A building shall be designed—

- (a) to withstand wind, seismic and accidental loading;
- (b) to withstand flood action for a defined flood event;
- (c) to resist floatation, collapse or significant movement from hydrostatic hydrodynamic scour, caused by a defined flood event;
- (d) to comply with elevation requirements,
- (e) to comply with material requirements and utilities; and
- (f) to enable occupant egress.

(4) A structural design shall be governed by ultimate limit state design requirements and pass serviceability limit state design checks.

(5) A building shall be designed to withstand actions during execution in accordance with KS EN 1991-1-6 (General Actions, Actions During Execution).

(6) An appropriate detailing shall be incorporated in the design to be in accordance with KS EN 1991-1-7 (General Actions, Accidental Actions).

(7) Appropriate execution of the design shall be carried out and the building shall be adequately maintained and used in accordance with the design.

61. The design of the structural system of a building shall be carried out in accordance with— Structural design.

- (a) KS EN 1990 (Basis of Structural Design);
- (b) KS EN 1991 (Actions on structures);
- (c) KS EN 1993 (Design of steel structures);
- (d) KS EN 1992 (Design of concrete structures);
- (e) KS EN 1994 (Design of composite steel and concrete structures);
- (f) KS EN 1995 (Design of timber structures);
- (g) KS EN 1996 (Design of masonry structures);
- (h) KS EN 1997 (Geotechnical design);
- (i) KS EN 1998 (Design of structures for earthquake resistance);  
and
- (j) KS EN 1999 (Design of aluminium structures).

62. (1) Where an owner is constructing a structural element, the material used in the construction of the structural element, or any component of the structural element, shall comply with the relevant Kenya Standard. Structural material.

(2) Where a material specified in a Kenya Standard is not available, an alternative material of equal or better performance may be used.

(3) The alternative material referred to in sub-paragraph (2) shall demonstrate suitability through laboratory testing using a sample sufficient to give a statistically conclusive result.

(4) The test referred to in sub-paragraph (3) shall be carried out at the cost of the owner.

(5) Where the alternative material referred to in sub-paragraph (2) is used in a building, the design of the building, structural elements and a component of the structural element, shall be in accordance with the safety method applicable to the structural use.

63. (1) A design of a structural system shall be prepared by an engineer. Professional obligations in structural design.

(2) The engineer referred to in sub-paragraph (1) shall confirm that the structure has been erected in accordance with the approved design, and shall furnish to the approving authority a certificate to that effect.

64. (1) The foundation of a building shall be designed to safely transmit all the loads from the building to the ground. Design for foundation.

(2) The requirement in sub-paragraph (1) shall be deemed to be satisfied where the design and construction of a foundation is in accordance with—

- (a) KS EN 1992 (Design of Concrete Structures); and
- (b) KS EN 1997 (Geotechnical Design).

(3) In every instance, the width of the foundation shall not be less than the width of the wall.

65. (1) A foundation of a building shall not be used to support a wall forming part of the building's structural system, except where— <sup>Empirical rules for foundation.</sup>

- (a) the wall is placed centrally on the foundation;
- (b) the soil supporting the foundation is not a heaving soil, shrinkable clay, or a soil with a collapsible fabric; or
- (c) the foundation is designed in such a manner that supports an eccentrically placed wall.

(2) The width of a continuous strip foundation shall be not less than—

- (a) 600mm where a foundation is for a load-bearing wall, a free-standing masonry wall, or for a timber framed wall which is supporting a roof with a Class B covering specified in Table 4 set out in the First Schedule; or
- (b) 400mm where a foundation is for a non-load-bearing internal masonry wall or for a timber framed wall supporting a roof with a Class A or Class C covering specified in Table 4 set out in the First Schedule.

(3) Where any strip foundation is laid at more than one level, the higher portion of the foundation shall extend over the lower portion for a distance that is at least equal to the thickness of the foundation.

(4) A void between the top of the lower portion of a strip foundation and the underside of the higher portion shall be completely filled with concrete of the same strength as that required for the foundation.

(5) Where a concrete floor slab is thickened to form a foundation—

- (a) the thickness, including that of the floor slab, shall be not less than that required for a continuous strip foundation; and
- (b) the width of the thickened portion below the floor slab shall be not less than that required for a continuous strip foundation.

(6) Despite sub-paragraph (5) (b), a thickening shall not be required under a non-load-bearing timber-framed wall.

(7) Where a pier is built into or forms part of a wall, the thickness of a foundation to the pier shall be the same as that required for the wall, and —

- (a) the length and width of the foundation to the pier shall project by 200mm at all points on the perimeter of the pier;
- (b) the thickness of the foundation to a sleeper pier or sleeper wall shall be at least 300mm;
- (c) the length or width of the foundation to a sleeper pier shall be at least 450mm; and
- (d) the width of the foundation to a sleeper wall shall be at least 300mm.

66. (1) Where an excavation related to a building is carried out, or proposed to be carried out on a construction site, and the excavation is likely to impair the safety or stability of any property or service, the owner shall take adequate precautionary measures to ensure that the safety and stability of the property or service, is maintained.

General stability requirements for excavation.

(2) While an excavation remains open or during the construction of a foundation in an excavation, the owner shall maintain the excavation in a safe condition.

(3) Where the safety or stability of a property or service is likely to be impaired by an excavation, or where the depth of the excavation is likely to exceed 3m, an owner shall—

- (a) obtain approval for the excavation; and
- (b) take the precautionary measures specified in the approval.

(4) An owner shall, at least seven days prior to the commencement of an excavation, notify the approving authority, in writing, of an intention to excavate.

(5) There shall be no excavation undertaken within 1m of an underground utility cable unless the—

- (a) excavation is done under the control of the operator of the utility system; and
- (b) excavation method is carried out in accordance with the approved work method statement.

67. (1) An excavation that exceeds a depth of 3m shall be designed by an engineer.

Excavations for foundation.

(2) An excavation for a foundation shall be taken down to firm natural ground.

(3) Despite sub-paragraph (2), it is permissible to cast a foundation in a filled ground if approved design measures are taken to ensure the stability and the serviceability of the building.

(4) The bottom of an excavation in the ground shall be horizontal.

(5) Where a foundation is placed on a solid continuous rock, the bearing area shall be cleaned and, where necessary, stepped or doweled to prevent lateral movement of the foundation.

(6) Except where the foundation for an external masonry wall is

placed on solid rock, the bottom of the excavation for a foundation shall not be less than 300mm below the level of an adjoining finished ground.

68. An engineer shall supervise and provide quality control at all stages of the design and construction of structural works. Structural works supervision.

69. Welding in the fabrication of structural steel work shall be undertaken only if approved in the design. Welding.

70. (1) A person shall not erect a canopy without approval. Canopy.

(2) A canopy shall—

- (a) be of an approved design and construction;
- (b) be at least 3.2m above the level of the footway; and
- (c) not extend outwards from the building to be nearer the vertical plane of the kerb line of the footway by a distance exceeding 0.7m.

(3) The upper surface of every canopy, shall be impervious to moisture and drained in the approved manner, and designed to prevent the discharge of water directly into a road.

(4) Where a canopy is to be erected in a building, the owner shall provide for it in the structural design.

71. (1) The dead load of a building or any part of the dead load shall be calculated from the unit weights given in KS EN 1991-1-1 (Actions on Structures, General Actions – Densities, Self-weight, Imposed Loads on Buildings), or from the actual known weights of the materials used. Dead load.

(2) In making the calculations referred to in sub-paragraph (1)—

- (a) where permanent partitions are shown in the plans, their actual weights shall be included in the dead load;
- (b) when partitions are indicated on the plans, their weight shall be included in the dead load acting as concentrated loads in their actual positions;
- (c) the weights of tanks and other receptacles, and of their contents, shall be considered as dead loads; and
- (d) the loads shall be calculated for the cases when a tank or receptacle is full and when it is empty.

72. (1) Imposed load shall be in accordance with the requirements of KS EN 1991-1-1 (Actions on Structures, General Actions, Densities, Self-weight, Imposed Loads on Buildings). Imposed load.

(2) The general requirements under sub-paragraph (1) are not applicable to certain unusual uses particularly where mechanical stacking, plant or machinery are to be installed, and in these cases the designer shall determine the loads from a knowledge of the equipment

and processes likely to be employed.

(3) Where partitions are not determined on the plans, the additional load on the beams and floors (for effective lateral distribution of the load) may be taken as a uniformly distributed load per 1m<sup>2</sup> of not less than a third of the weight of the partitions per 1m run of the finished partitions.

(4) The following loads shall be adopted in the design of frames coverings of access hatches (other than glazing), the supports of ceilings and similar structures—

- (a) without access, no imposed load; or
- (b) with access, 0.25kN/m<sup>2</sup> uniformly distributed over the whole area or the area supported and a concentrated load of 0.9kN placed to produce maximum stresses in the affected members.

73. A reduction in the total imposed load shall be in accordance with KS EN 1991-1-1 (Actions on Structures, General Actions, Densities, Self-weight, Imposed Loads on Buildings).

Reduction in total imposed load.

74. (1) The calculation for the imposed load on a roof shall be in accordance with KS EN 1991 (Actions on Structures).

Imposed load on roof.

(2) A roof slope shall be measured from the horizontal when a load is applied vertically.

75. The load for actions induced by cranes and machinery shall be in accordance with KS EN 1991-3 (Actions on Structures, Actions Induced by Cranes and Machinery).

Imposed crane gantry girder.

76. A building that is susceptible to swaying or activities that could introduce vibrations at resonance frequency, dynamic loading shall be designed in accordance with KS EN 1991 (Actions on Structures).

Dynamic loading (excluding wind).

77. The design for a live load for a vehicular bridge shall be in accordance with KS EN 1991-2 (Actions on Structures, Traffic Loads on Bridges).

Vehicular bridge live load.

78. The design for a parapet or balustrade shall be in accordance with KS EN 1991-1-1 (Actions on Structures, General Actions).

Parapet and balustrade.

79. (1) The design of a structure exposed to fire shall identify suitable fire scenarios that are appropriate to the building, depending on—

Action on structure exposed to fire.

- (a) the fire risk assessment;
- (b) likely ignition sources; and
- (c) the available fire detection or suppression systems.

(2) The scenario identified under sub-paragraph (1) shall inform the design choice for a structure exposed to fire.



(3) Construction works shall be designed and built in such a way that in the event of a fire outbreak, the load bearing resistance of the construction works shall be in accordance with the period of time specified in KS EN 1991-1-2 (General Actions – Actions on Structures Exposed to Fire).

80. (1) A design of a building, structure or any component thereon shall take into account thermal action. Thermal action.

(2) For purpose of this paragraph, thermal action refers to variable indirect actions resulting from changes in the temperature of structural elements exposed to daily and seasonal changes.

(3) The design against thermal action shall be in accordance with KS EN 1991-1-5 (General Actions, Thermal Actions).

(4) Where necessary, a check that thermal movement shall not lead to overstressing shall be done by—

- (a) provision of movement joints; and
- (b) designing for the future effects of thermal movement.

81. (1) A design of a building, structure and any component thereon shall take into account a wind load. Wind load.

(2) A calculation of a wind load shall—

- (a) be in accordance with KS EN 1991-1-4 (General Actions – Wind Actions Suitable Wind Pressures); and
- (b) factor in the varying heights or different structural shapes and other factors that may be involved.

82. (1) The design for an earthquake load shall be in accordance with KS EN 1998 (Design of Structures for Earthquake Resistance). Earthquake load.

(2) The seismic zoning map of Kenya as provided by the Ministry responsible for Mines and Geology shall be used to determine earthquake intensities.

83. Where the eccentric load of a foundation to a wall occurs, the wall shall be designed such that the resulting force shall pass through the middle third of the foundation. Eccentric load of the foundation.

84. Where a cantilever or similar structural element projects from a wall of a building the supervising engineer shall provide for the stability of the structure. Cantilever resistance to overturning.

85. (1) The foundation of a building shall be— Foundations generally.

- (a) designed and constructed so as to sustain the combined dead load of the building and imposed loads, and to transmit these loads safely to the ground such that the pressure on the ground does not cause any settlement impairing stability of the building, adjoining works or structures;
- (b) of such depth as to safeguard the building against damage by swelling, shrinking or erosion of the subsoil; and

- (c) take into consideration lateral displacement limits in accordance with KS EN 1991-1-4 (General Actions – Wind Actions Suitable Wind Pressures).

(2) If a building has a heavily loaded foundation, the substrata formation shall be proved when tested according with KS EN 1997 (Geotechnical design).

(3) The dead load and imposed loads, including wind and earthquake loads, shall be calculated in accordance with KS EN 1991 (Actions on Structures).

(4) A design of a foundation for a building of more than four storeys shall be preceded by a geotechnical report determining the critical design parameters including—

- (a) allowable bearing pressure;
- (b) cohesion of the soil; and
- (c) content of chlorides and sulphates in the soil.

86. (1) The foundation of a load bearing structure of a single storey building, where constructed as a strip foundation of plain concrete situated centrally under the walls or piers, shall be constructed in such a manner—

Strip foundation for single storey building.

- (a) that a wide variation in the type of subsoil over the loaded area and no weaker type of soil exists below that on which the foundation rests within a depth as may impair the stability of the structure;
- (b) that can withstand pressure according to the type and condition of the soil as specified in Table 5 set out in the First Schedule;
- (c) that the concrete is composed of cement and well-graded aggregate in the proportion of 50kg of cement to not more than 0.35m<sup>3</sup> of well-graded aggregate; and
- (d) that ensures the thickness of the concrete is at least that of its projection from the base of the wall or footings, and is at least 250mm, except that where the foundation bed is of hard rock only, sufficient concrete is needed to level the foundation in masonry courses.

(2) If a single storey residential building is constructed with external walls of a thickness of 150mm, the thickness of the concrete used in the strip foundation may be reduced to at least 150mm if the bearing capacity of the subsoil is at least 75kN/m<sup>2</sup>.

(3) Where the strip foundation is laid at more than 1 level, at each change of level, the higher level of the foundation shall extend over and unite with the lower level of the foundation for a distance that is not less than the thickness of the levels of the foundation, and is at least 300mm.

(4) Where there is a pier or buttress forming part of a wall, the strip foundation shall project beyond the pier or buttress on all sides, and at least to the same extent as they project beyond the wall.

(5) The conditions of the subsoil for the purposes of Table 5 set out in the First Schedule, shall be determined by the results of a soil test certified by an officer authorised by the approving authority.

#### PART VII—SPACES WITHIN BUILDINGS

87. (1) A room or space within a building shall have the dimensions that will ensure that the room or space is fit for the purpose for which it is intended.

Space requirements for room or space within a building.

(2) A habitable room shall be a dwelling room which has a minimum superficial area of 7.0m<sup>2</sup> for a single room occupancy and a minimum internal dimension of 2.1m.

(3) The number of persons to be accommodated in a habitable room shall be determined on the basis of 3.5m<sup>2</sup> per person.

(4) A residential building, and a part of a residential building which is intended to be separately let for dwelling purposes, shall have a kitchen and sanitary facility.

(5) The internal surface of every kitchen, to a height of at least 1.2m from floor level shall be faced with tiles, or rendered in cement mortar, of at least 12.5 mm in thickness, or other approved non-absorbent material.

(6) A kitchen shall have—

- (a) a properly constructed fireplace, or cooking slab, with an extraction flue; and
- (b) a sink and fittings for the supply of water.

88. (1) The plan dimensions of a room or space shall be the horizontal dimensions between un-plastered internal wall surfaces.

Plan dimensions.

(2) The floor area shall be based on the plan dimensions but shall not include an area occupied by a built-in cabinet, cupboard, a dividing wall or partition.

(3) The floor area of a room shall be at least that specified in Table 6 set out in the First Schedule and as specified in Figure 6 set out in the Second Schedule.

(4) At least two spaces shall be deemed to be one room if a dividing wall or partition, including a door, erected between the spaces, occupies less than 60% of the area of the separating plane.

89. (1) The height of a room or space, shall be at least that specified in Table 7 set out in the First Schedule and in Figure 7 set out in the Second Schedule.

Room height.

(2) The height referred to in sub-paragraph (1) shall be measured from the top of the finished floor to—

- (a) the underside of the ceiling;
- (b) the underside of the roof covering where there is no ceiling;  
or
- (c) the underside of a structural member where the structural member projects below the ceiling or to a roof covering and the plan area of the projections exceed 30% of the plan area of the room.

(3) Despite the specifications in Figure 7 set out in the Second Schedule, where a structural member projects below the level of the ceiling, or where there is no ceiling, below the level of the roof covering, the height to the projection shall be at least 2.4m.

90. The overall plan area of a multipurpose room shall be not less than 10.5m<sup>2</sup>.

Floor area of multipurpose room.

91. A balcony projected from an upper storey of a building shall have a clear height from the floor of the balcony, of at least the height of the storey from which it projects.

Protection of balcony or veranda.

92. (1) An opening placed on an external wall above the ground floor of a building shall be protected by a barrier which shall be at least 1.1m high.

Protection of opening.

(2) The lowest 150mm of the barrier referred to in sub-paragraph (1) shall be a wall.

(3) The barrier referred to in sub-paragraph (1) shall be designed to minimize the risk of a person or objects falling, rolling, sliding or slipping through a gap in the barrier, or persons climbing over the barrier.

93. (1) A room used, or intended to be used, as an office or for habitation, shall have a height of at least 2.4m measured from the floor to the ceiling:

Height of storey.

Provided that where there is no ceiling, the height of the room shall be measured from the floor to the underside of a beam.

(2) Where a room has a sloping ceiling, the height referred to in sub-paragraph (1) shall be measured as the mean height of the ceiling above floor level:

Provided that no portion of the room shall have a height of less than 2.1m.

94. The minimum dimension of a landing, lobby or passage shall not be less than the width of the staircase to which it leads.

Landing, lobby or passage.

95. The distance from a part of a building intended for habitation, a school or a building used as a place of public assembly, shall not exceed 30m from a staircase, passage or other normal means of exit.

Distance from staircase.

96. Where an owner intends to install a swimming pool the installation shall be conducted in accordance with KS 2793 (Swimming pool equipment).

Swimming pool.

## PART VIII—FLOORS

97. (1) The floor of a building shall—
- Requirements for floor.
- (a) be strong enough to safely support its own weight and any load to which it is likely to be subjected; and
  - (b) have a fire resistance appropriate to its use and where required, be non-combustible.
- (2) The floor of a laundry, kitchen, shower-room, bathroom or room containing a water closet pan or urinal, shall be water-resistant and non-slippery.
- (3) A suspended floor made from timber shall have under-floor ventilation.
- (4) Where a concrete floor slab is supported on the ground or filling, the floor shall be constructed in a manner that ensures that the moisture present in the ground or filling is prevented from penetrating the concrete floor slab.
- (5) A floor on the ground or on a filling, shall be constructed of—
- (a) an impervious floor unit of at least 40mm thick and consists of slate, bricks, natural stone or other approved material; or
  - (b) a concrete slab of a compressive strength of between 16N/m<sup>2</sup> to 20N/m<sup>2</sup> at twenty-eight days, and of a thickness of at least 75mm.
98. (1) Where a floor is to be constructed on a construction site consisting of black cotton soil, the black cotton soil shall be entirely removed down to rock level or removed to such other level as may be approved by an engineer.
- Floor constructed on black cotton soil.
- (2) Subject to sub-paragraph (3), the area excavated in accordance with sub-paragraph (1) shall be filled with suitable hard core consolidated and blinded with fine material to a level finish.
- (3) Where, the depth of the black cotton soil referred to in sub-paragraph (1) does not exceed 1.8m—
- (a) the soil shall be removed to a depth of at least 0.9m;
  - (b) a construction site overlay of 100mm thick of consolidated murrum, or 75mm thick of concrete of a strength of at least 1:4:8 shall be laid; and
  - (c) the remaining excavation shall be filled in the manner described in sub-paragraph (2).
- (4) Where the floor referred to in sub-paragraph (1) is a suspended floor—
- (a) the level of the black cotton soil shall not exceed 150mm below the level of the underside of the floor; or
  - (b) if the floor is a timber floor, the level of the black cotton soil shall not exceed 50mm below the level of the underside of the floor.

99. (1) A floor shall be constructed in accordance with the requirements for fire safety and fire installations specified in Part XXI. Construction of floor.
- (2) An under-floor membrane shall be of at least 1000gauge and shall be laid on a surface which shall not contain any sharp object.
- (3) The membrane referred to in sub-paragraph (2) shall be turned up around the perimeter for the full thickness of any slab.
- (4) A joint in the membrane referred to in sub-paragraph (2) shall be double-lapped by at least 150mm and shall be effectively sealed.
- (5) A filling material shall—
- consist of suitable material approved by an engineer; and
  - be applied in well compacted layers whose thickness does not exceed 150mm.
- (6) A floor finishing detail shall be made of non-slippery material and shall be approved by an engineer.
- (7) In a building where the structural parts are made of timber the structural parts shall be properly protected against termites in accordance with KS 1002 (Anti-termite measures in buildings – Pre-constructional chemical treatment measures) and KS 1003 (Anti-termite measures in buildings – Treatment for existing buildings).
100. (1) Timber design shall be in accordance with KS EN 1995-1-1-2004 (2006) (Design of timber structures – Part 1-1 – General Common rules and rules for buildings). Timber floor.
- (2) Timber grading shall be in accordance with KS 771 (Specification for softwood timber grades for structural use) and the performance of structural cross laminated timber shall be in accordance with ISO 16696-1 (Timber structures – Cross laminated timber – Part 1: Component performance, production requirements and certification schemes).
- (3) Where the timber species used in a building is cypress, the general grade and the timber used for the construction of joists of the floors of a residential building, shall be in accordance with the sizes specified in Table 8 set out in the First Schedule.
- (4) To secure due stability of a floor, trimming and trimmer joists may be of such additional thickness as may be necessary.
- (5) In flooring—
- where joists are placed within 400mm of each other, centre to centre, the flooring boards shall be at least 25mm thick;
  - where the spacing does not exceed 450mm, the flooring boards shall be at least 30mm thick; and
  - where the spacing does not exceed 600mm, the flooring boards shall be at least 40mm thick.

## PART IX—WALLS

101. A wall shall—
- (a) safely sustaining any loads to which it is likely to be subjected; and
- (b) in the case of a structural wall, transferring any loads to the foundation.
102. (1) Where a roof truss, rafter or beam is supported by a wall, the truss, rafter or beam shall be fixed to the wall to enable the wall to withstand any force that is subjected to the roof.
- (2) The roof shall be fixed in such a manner as to direct rain water away from the walls.
103. A wall shall be constructed in accordance with the requirements for fire safety and fire installations specified in Part XXI.
104. (1) A masonry unit used in a wall shall be constructed in accordance with—
- (a) KS 547 (Specification for burnt clay building blocks);
- (b) KS 625 (Specifications for Precast Masonry Units);
- (c) KS 2023 (Natural stone masonry units – Specification); or
- (d) KS EAS 54 (Burnt building bricks – Specification).
- (2) The material used in a wall of a timber framed construction shall be in accordance with KS 771 (Specification for softwood timber grains for structural use).
- (3) The compressive strength requirements specified in Table 9 set out in the First Schedule shall be used for all walls.
- (4) Mortar used in the erection of the wall of a building shall be prepared in accordance with Table 10 set out in the First Schedule.
105. (1) The height and unsupported length of a masonry wall shall be constructed in accordance with the dimensions specified in Table 11 set out in the First Schedule.
- (2) The height and unsupported length of a timber framed construction, shall not exceed the dimensions specified in Table 12 set out in the First Schedule.
- (3) The engineer supervising construction works shall ensure that a gable wall has adequate lateral support.
- (4) Where effective lateral support is to be provided to a masonry wall by an intersecting masonry wall, the intersecting wall shall—
- (a) be constructed of a masonry unit or mortar of the strength that is not less than that of the masonry unit or mortar, respectively, that is used in the wall it supports;
- (b) intersect the supported wall at an included angle of between 60° and 120°;
- (c) have a height of at least 80% of the height of the supported wall;
- (d) have a thickness of at least—
- (i) the supported wall, or a load-bearing leaf of the supported wall, where the supported wall is a structural wall;

Structural strength and stability.

Roof fixing.

Fire resistance.

Empirical regulation for wall.

Wall dimensions and opening.

- (ii) 45% of the thickness of the supported wall, or 90mm, whichever is the greater, where the supported wall is a non-structural wall and the thickness, in the case of a cavity wall is deemed to be the sum of the thickness of the leaves of the wall; and
- (e) have a length of at least—
  - (i) ten times the thickness of the supported wall, or load-bearing leaf of the supported wall, where the supported wall is a structural wall; or
  - (ii) one-fifth of the height of the wall panel to be supported, or one-eighth of the greatest distance between the intersecting wall and another intersecting wall providing lateral support, whichever is the greater, where the supported wall is a non-structural wall and the length shall not include the thickness of the supported wall.
- (5) Where an integral masonry pier is used in a non-structural masonry wall to provide resistance to flexure in the vertical plane, the pier shall—
  - (a) have a depth perpendicular to the length of the wall, of three times the thickness of the wall where the depth includes the thickness of the wall;
  - (b) have a width along the length of the wall of twice the thickness of the wall; and
  - (c) be effective only if the height of the pier is at least 80% of the height of any of the walls.
- (6) The storey height is measured from floor level to floor level of the next storey and, in the case of the topmost storey, from floor level to eaves and the maximum height of any wall panel shall be equal to the relevant storey height specified in Table 11 set out in the First Schedule.
- (7) In determining the distance between intersecting walls, a concrete column, or any other member providing effective lateral support to a wall, and to which it is securely bonded or anchored, and if the wall panel is supported at one end only, the unsupported length shall not exceed half of the tabulated length.
- (8) The exterior leaf a cavity wall may be constructed as a masonry wall of a nominal thickness of 90mm in accordance with Table 11 set out in the First Schedule, where the exterior leaf is tied to the interior leaf of the cavity wall, and the interior leaf of the cavity wall is a structural concrete wall.
- (9) A lintel shall be provided where there is an opening and designed based on the span of the opening.

106. (1) An external masonry cladding or infilling panel in a framed building shall be horizontally and vertically anchored to the structure of the building.

External masonry cladding or infilling panel in framed buildings.



(2) Where the area of an opening in the infilling panel referred to in sub-paragraph (1) exceeds 20% of the face area of the infilling panel, the top of the infilling panel shall be anchored to the structure of the building in such a manner that provides for vertical movement of the wall but restrains the wall against lateral movement.

(3) The cladding referred to in sub-paragraph (1) shall be supported on beams, slabs or nibs at each storey and a provision shall be made for relative vertical movement between the cladding and the structure frame at the underside of the supports.

(4) Movement joints shall be provided in the cladding at intervals not exceeding 10m to allow for relative horizontal movement.

107. (1) A masonry column or pier between openings in a wall shall have a height that does not exceed twelve times the least lateral dimension.

Column and pier  
in wall.

(2) The strength and stability of a column or pier shall be substantiated by calculation and performance tests.

108. (1) A cavity formed in an external masonry cavity wall shall be at least 50mm wide and shall not exceed 110mm wide.

Cavity wall.

(2) A wall tie shall be installed in a cavity wall in an evenly distributed pattern, at a rate of 2.5 ties per 1m<sup>2</sup> of the face area of the wall where the cavity does not exceed 75mm in width, and at a rate of three ties per 1m<sup>2</sup> of the face area where the cavity exceeds 75mm in width.

(3) A wall tie shall be installed in accordance with EN 845 (Specification for ancillary components for masonry – Wall ties, tension straps and brackets).

109. (1) The height of a foundation wall that does not act as a retaining wall shall not exceed 1.5m.

Foundation wall.

(2) Where a difference in ground level including backfill exists between the two sides of a foundation wall that is acting as a retaining wall, the difference shall not exceed 1m.

(3) A foundation wall shall have the minimum thickness specified in Table 13 set out in the First Schedule.

(4) Despite sub-paragraph (3), the thickness of a foundation wall shall not be less than—

- (a) the thickness of the wall carried by the foundation wall; or
- (b) in the case of a cavity wall, the sum of the thicknesses of the leaves of the cavity wall where the wall carried by the foundation wall is a cavity wall.

110. (1) A residential building shall not be erected against a retaining wall which exceeds 4.5m in height.

Building abutting  
retaining wall.

(2) A space of at least 1.5m in width shall be left between a residential building and a retaining wall which exceeds 4.5m in height.

111. A retaining wall, which forms part of a residential building shall be—
- Retaining wall forming part of building.
- (a) waterproofed to prevent dampness in the building; and
  - (b) insulated to prevent condensation on the internal face of any room intended for habitation within the building.
112. In a building—
- Balustrade wall.
- (a) a solid masonry balustrade wall shall—
    - (i) be tied to reinforced concrete, a block column or bonded into a return wall or a reinforced brick pier; and
    - (ii) where deemed necessary, have expansion joints spaced not more than 8m apart where the wall is supported by reinforced concrete, a brick column or reinforced brick pier, and the expansion joints shall be formed in the column or pier;
  - (b) a return wall or reinforced brick pier shall be bonded into the structural beam or slab, and the return wall shall not be spaced further apart than 6m for a 230mm thick wall, or 5m for a 180mm thick wall, or 4m for a 110mm thick wall;
  - (c) a brick balustrade wall shall be reinforced in the highest four bed joints with a reinforcement which consists of two strands of a galvanized steel wire of at least 3.5mm in diameter, or two flat galvanized strips of an equivalent area and the reinforcement shall have a lap of at least 150mm with the anchors to the supporting columns or piers.
113. (1) Where a free-standing wall is a masonry wall—
- Free-standing wall.
- (a) the courses of the wall shall be laid in an acceptable fully-bonded pattern; and
  - (b) the height, thickness and pier size of the wall shall be according to the dimensions specified in Table 14 set out in the First Schedule and any cavities in piers in a wall constructed of hollow units shall be filled with concrete.
- (2) In the case of a precast concrete fence, the fixing of posts shall be in accordance with KS 1186 (Specification for reinforced concrete posts and struts).
- (3) A damp-proof course shall not be installed in a free-standing wall.
- (4) Where moisture is likely to be encountered from ground water, high density bricks with a water absorption not exceeding 7% shall be used in a free-standing wall up to 150mm above ground level.
- (5) Where a wall consists of at least two sections of different thicknesses—
- (a) the thickness of the top section shall be less than that of a lower section;

- (b) the height of the top section shall not exceed 80% of the maximum height specified in Table 14 set out in the First Schedule for the thickness in question;
- (c) the sum of the heights of the various sections of the wall shall not exceed the prescribed height for the thickest section of the wall; and
- (d) any piers used in the thickest section of the wall shall extend, without reduction in size, to the top of the wall.

114. (1) A masonry retaining wall, not being a basement or foundation wall of a building, shall not be erected in a position where the ground or fill which it retains may be subject to a superimposed load, other than that from pedestrian traffic within a distance equal to the height of the fill retained by the wall.

Retaining wall of masonry.

(2) Where a structure is to be erected on top of a masonry retaining wall, the wall shall not be regarded as a structure, unless a wire fence not exceeding 1.5m in height is installed above the wall.

(3) There shall not be a surcharge of fill behind a masonry retaining wall within a distance equal to the height of the wall.

(4) Movement joints shall be provided at distances not exceeding 10m.

(5) A subsoil drainage shall be provided behind a masonry retaining wall together with sufficient weep holes in the wall to prevent the accumulation of water.

(6) A horizontal damp-proof course of sheet material shall not be used in a masonry retaining wall.

(7) A masonry retaining wall shall—

- (a) be constructed of solid masonry units laid in a fully-bonded pattern;
- (b) not exceed the height, wall thickness and pier size specified in Table 15 set out in the First Schedule and where piers are indicated in the table, the length of a wall shall be supported at each end by a pier and all the piers in the wall shall project from the edge of the wall which is not in contact with the fill, and be bonded with the wall and extend the full height of the wall.

115. (1) In the case of a wall erected using masonry units or concrete, a galvanized steel strap or wire, or any other material approved by the approving authority, shall be embedded in the wall at positions that ensure the anchoring of a timber roof truss, rafter or beam to the wall.

Roof anchoring.

(2) The strap or wire referred to in sub-paragraph (1) shall extend into the wall to a depth of at least 300mm, if it is for a heavy roof comprising of concrete or clay tiles or slate, or at least 600mm, if it is for a sheet roof, except that where the depth of a masonry unit is less than 300mm, or in-situ concrete is less than 600mm, the strap or wire shall extend as far as possible into the masonry unit or concrete.

(3) A galvanised steel strap anchor shall be taken up over the top of the rafter or tie beam, bent down on the other side and nailed down from both sides.

(4) A galvanised roof tie shall be made up of two strands of wire which shall be taken up on either side of the rafter or tie beam, twisted together so as to have no slack, but not to overstrain the wire and the free ends, then nailed down to prevent untwisting.

(5) In the case of a building of timber framed construction, the provision for anchoring of a timber roof truss, rafter or beam to the wall shall be in accordance with KS EN 1995-1-1 (Design of timber structures – General Common rules and rules for buildings).

(6) The anchor used in the construction of any roof truss, rafter or beam shall be in accordance with Table 16 set out in the First Schedule.

116. (1) A contractor shall construct a wall which resists the penetration of water into any part of the building where it may be detrimental to the health of the occupants or to the durability of the building.

Water penetration.

(2) The external wall of a building shall satisfy the relevant requirements of the rain penetration test specified in paragraph 117.

(3) The external wall of a building may be—

- (a) a single leaf externally plastered block wall that is at least 140mm thick, or a single leaf brick wall that is at least 190mm thick;
- (b) a cavity wall built of masonry;
- (c) a precast concrete wall that forms part of a garage or garden store and has a nominal thickness of at least 40mm and the joints in the wall are sealed; or
- (d) a timber framed wall built in accordance with KS EN 1995-1-1 (Design of timber structures – General Common rules and rules for buildings).

(3) In an area prone to prolonged heavy wind-driven rain, an external masonry wall shall be a cavity wall, or a double leaf wall with the inner face of the outer leaf bagged and painted with two coats of an approved sealer.

117. (1) An owner shall ensure that a wall is thoroughly air-dried before it is tested.

Rain penetration test for wall.

(2) In the case of a masonry or similar wall—

- (a) the inner surface may be lime washed, or other means may be adopted to facilitate the detection of moisture which has penetrated through the wall;
- (b) the portion of the outer surface under test shall then be continuously sprayed with water in the form of a finely

divided spray distributed over the whole area under test at the rate of 40mm to 50mm depth of water per hour; and

- (c) spraying shall be conducted in a still atmosphere and shall be continued for the minimum period specified in Table 17 set out in the First Schedule, depending upon the mean annual rainfall and the hourly mean wind speed for the locality concerned specified in the table relative to the period in each case, or until the first signs of dampness appear on the inner surface of the wall if the signs appear before the expiry of the period.

(3) In the case of any timber framed wall the covering of the wall shall be removed after the required test period in order to ascertain whether any moisture has penetrated to the interior of the wall and if so, whether water has been retained within the interior.

(4) The test criteria applicable shall apply to the test wall, with regard to rain penetration, and shall be considered to have complied with the requirements of paragraph (2) where—

- (a) no moisture has penetrated to the inner surface of the wall within the relevant minimum test period in column 3 of Table 17 set out in the First Schedule; and
- (b) in the case of a timber framed wall, there is no evidence of water having been retained within the cavity in the wall.

(5) For a test period specified in Table 17 set out in the First Schedule—

- (a) KS EN 1991-1-4 (Actions on structures – Part 1-4: General actions – Wind actions) may be adopted for the general procedures and loadings for the design of buildings;
- (b) if the annual rainfall exceeds 1000mm<sup>3</sup>, the test shall be conducted based on the criteria for an area which receives a maximum annual rainfall of 1400mm<sup>3</sup>; and
- (c) where the actual annual rainfall is known to exceed 1400mm<sup>3</sup>, the period for the duration of the test may be linearly extrapolated.

118. (1) A wall or sleeper pier of a building shall have damp-proof courses in such position and to such an extent as to protect the wall against rising damp and the interior of the building against ingress of moisture from the abutting ground.

Damp-proof course.

(2) Material used as a damp-proof course shall be in accordance with BS 6398 (Specification for Bitumen).

- (3) A damp-proof course shall be installed in a masonry wall —
  - (a) at the level of the top of a concrete floor slab resting on the ground; or
  - (b) where applicable, below any ground floor timber beam or joist.

(4) In a timber framed wall, a damp-proof course shall be installed between the bottom plate of the wall and a foundation wall or concrete floor slab.

(5) In the case of a solid masonry wall or a timber framed wall, a damp-proof course shall extend over the full thickness of the wall.

(6) In the case of a masonry cavity wall—

- (a) each leaf of the wall shall have its own damp-proof course which shall extend over the full thickness of the leaf, in which case the cavity shall extend 150mm below the damp-proof course; or
- (b) each leaf of the wall shall be covered by a membrane which extends across the cavity.

(7) The position of the membrane referred to in sub-paragraph (6)(b) at the inner leaf shall be higher than at the outer leaf.

(8) Where necessary, weep holes spaced at intervals not exceeding 1m apart, shall be provided in the external leaf of every cavity wall, in the masonry unit course—

- (a) that is immediately below the damp-proof course referred to in sub-paragraph (6)(a); or
- (b) that is immediately above the membrane contemplated in sub-paragraph (6)(b).

(9) A horizontal damp-proof course shall not be installed below 150mm above the level of the adjacent finished ground.

(10) Transverse joints in the damp-proof course shall be overlapped to a minimum distance of 150mm and at junctions and corners to a distance equal to the full thickness of the wall or the leaf, as the case may be.

(11) Where a part of a wall of a room is such that the ground is in contact therewith, it shall be protected by a vertical water-proof membrane or by a drained cavity which shall extend below the level of the floor of the room; and drainage shall be provided at the base of the wall to prevent water accumulating there.

119. An external wall of a residential or public building, or a building whose occupancy is classified as F4 specified in Table 1 set out in the First Schedule, or a parapet wall, shall be constructed so as to resist the penetration of rain.

External wall weather resistance.

120. An owner shall ensure that a wall, pier or column of a building, does not permit the passage of moisture from the ground to the inner surface of a storey of the building, or to a part of the building that may be affected by the moisture.

Protection against moisture from the ground.

121. (1) The cavity in a cavity wall, built of bricks or blocks or any other approved material, shall extend downwards to at least 150mm below the level of the lower damp-proof course in that wall.

Prevention of dampness in cavity wall.

(2) In every cavity wall wherever the cavity is bridged, a damp-proof course, or flashing shall be arranged, so that moisture is directed away from the inner leaf of the wall, shall be inserted unless the bridging occurs at a place protected by the roof.

122. (1) The dimensions of a non-load-bearing wall shall not exceed the dimensions specified in Table 18 set out in the First Schedule.

Non-load-bearing wall.

(2) This paragraph shall not apply to the construction of—

- (a) a load bearing structure or wall;
- (b) a pier;
- (c) a column;
- (d) a brick wall; or
- (e) a stone wall.

(3) Where blocks which are up to 1m thick are used in a non-load-bearing wall, alternate courses shall be reinforced in an approved manner.

(4) A concrete block used in a non-load bearing external panel wall shall be constructed in accordance with KS 625 (Specifications for precast masonry units).

123. An un-faced stone, brick, block or slab used in an external wall shall be faced externally by a rendering of at least 15mm thick or similar treatment where the permeability of the blocks requires.

Rendering.

124. A hollow block shall not be used in a sub-structure foundation wall or in the construction of chimneys.

Hollow block not to be used in foundation wall or chimney.  
Sealing of cavity wall.

125. A cavity wall shall be sealed at the point where the cavity wall joins the structural frame or another wall, or at the end of the cavity wall.

126. For a load bearing or a non-load bearing wall, the mortar shall be in accordance with the classes specified in Table 10 set out in the First Schedule.

Mortar.

127. (1) A chase shall not be cut so as to weaken the structural strength of the building below the design limit.

Chase.

(2) In a solid block, the depth of horizontal chases shall not exceed one-sixth of the thickness of the block and for vertical chases, a third of the thickness of the block.

(3) In the case of load bearing structures, chases shall be cut under the supervision of an engineer.

128. (1) This paragraph shall apply to an external wall of a residential building.

External wall in residential building.

(2) If the height from the level of the floor of the storey to that of the ceiling does not exceed 3m, and the floor, if not the ground floor, is

constructed of reinforced concrete throughout and extends over the walls of the storey below, the wall of the top or only storey may be—

- (a) reduced to 200mm in thickness with a tolerance of 2mm, if built of square dressed stone, bricks or concrete blocks; and
- (b) supported at intervals not exceeding 4m by a buttressing wall, or at a position of the wall that is at least 300mm thick for a length of 4m.

(3) The wall referred to in sub-paragraph (2) may be 3.3metres in height and buttressed at intervals not exceeding 5m if the bearing stresses thereof are not thereby exceeded, and—

- (a) where a timber roof construction is used, a ring beam shall be provided at a ceiling level of at least 200mm in both breadth and depth reinforced with two 12mm bars evenly distributed in the bottom that has a cover of at least 20mm, and the roof is tied thereto; or
- (b) a reinforced concrete flat roof is imposed.

(4) A partition wall shall not be deemed to be a buttressing wall unless the length thereof is at least 200mm bonded into the outer wall for its full height and it is at least 200mm thick with a tolerance of 2mm.

129. (1) A party wall or separating wall, built of bricks, blocks or stone, shall have a thickness of at least 200mm.

Party and separating wall.

(2) A party wall or separating wall for a residential building constructed with an external wall which is 200mm thick, shall be constructed in accordance with paragraph 128.

- (3) A wall, which is continuous with a boundary, shall—
  - (a) be constructed in accordance with the requirements of a party wall under in subparagraphs (1) and (2);
  - (b) be constructed in accordance with the requirements of an external wall under paragraph 128; and
  - (c) have e notional period of fire resistance for the structural design of the building in accordance with KS EN 1991 (Actions on Structures).

130. (1) A boundary wall shall be constructed of approved building materials and shall be erected with sufficient supports fixed to ensure the stability of the wall or fence.

Boundary wall.

(2) A boundary wall shall be erected in a vertical plane or as designed and approved, and a fence shall be finished with an approved preservative.

(3) A boundary wall shall be of a height that does not exceed 2.4m.

(4) A boundary wall shall be consistent with the character of the road.



131. A parapet wall shall have a coping that is designed and installed so as to prevent vertical water penetration. Coping to parapet wall.

132. Subject to paragraph 394, where a finished surface of a wall is to be painted, the paint applied shall comply with— Painting of wall.

- (a) KS EAS 849 (Silk (sheen) emulsion paint interior use-Specification);
- (b) KS 1985-1 (Marine paints – Specification – Part 1: Two-pack epoxy primer marine paint);
- (c) KS 1985-6 (Marine paints – Specification – Part 6: Two-pack full gloss polyurethanemarine paint);
- (d) KS 1985-10 (Marine paints – Specification – Part 10: Hydrolysing organosylil polymer-based antifouling marine paint);
- (e) KS EAS 850 (Matt solvent-borne paint for interior and exterior use – Specification);
- (f) KS EAS 851 (Matt emulsion paint for interior and exterior use – Specification); or
- (g) KS EAS 852 (Air-dried roofing paint – Specification).

#### PART X—LIGHTING AND VENTILATION

133. (1) A room shall have a means of lighting and ventilation which shall enable the room to be used for the purpose for which the room is designed without detriment to the health or safety, or causing nuisance. Lighting and ventilation of room.

(2) The requirement of sub-paragraph (1) shall be deemed to be satisfied where the room is provided with—

- (a) at least one opening for natural light and ventilation; or
- (b) artificial lighting and ventilation in accordance with paragraph 135.

(3) Despite sub-paragraph (2) (a), a corridor, lobby or staircase serving the room shall have a means of artificial lighting.

(4) A room for which natural ventilation is not possible shall have a means of artificial ventilation.

134. (1) A window, vent or any other part of a building shall be constructed so as to face or ventilate, directly or otherwise, into the external air, open air, an aperture, airshaft, or communicate with the open air. Window and vent to face or ventilate into open air.

(2) A window, vent or other part of the building, shall only face or ventilate into an aperture, or airshaft, or communicate with an open veranda, balcony or any other open place, if in doing so, the window, vent or other part of the building, shall not prejudice the standards of lighting or ventilation or the health of the occupiers of the building.

135. (1) Where an owner installs an artificial ventilation system in a building, the design of the artificial ventilation system shall be prepared by an engineer.

Artificial ventilation system.

(2) The engineer referred to in sub-paragraph (1) shall confirm that the ventilation system has been installed in accordance with the approved design, and furnish the approving authority with a certificate to this effect.

(3) A plant that forms part of an artificial ventilation system shall be designed, located and protected to ensure that—

- (a) condensate from the plant does not pose a danger or nuisance to the public;
- (b) inspection and servicing can be undertaken; and
- (c) a person cannot tamper with the plant.

(4) An owner shall conduct a test annually to ascertain whether the artificial ventilation system installed is operating in the designed manner and shall submit the test reports to the approving authority.

136. (1) Where a room is provided with at least one opening, the opening shall be situated in an external wall, or in a suitable position in the roof of the building, for the purposes of natural lighting.

Natural lighting.

(2) The use of an approved tubular daylight device to bring in natural lighting in a space that does not have an opening on the external walls or roof lighting, such as basements, is permissible and recommended, where the light intensity achieved is sufficient for the intended use of the space.

(3) Where the opening referred to in sub-paragraph (1) is glazed, the opening shall be glazed with transparent or approved translucent glazing material.

(4) The area of the opening referred to in sub-paragraph (1), or the total area of the openings, inclusive of frames and glazing bars, shall be at least 10% of the floor area of the room or rooms served by it or them, respectively, or 0.2m<sup>2</sup>, whichever is the greater.

137. (1) The opening referred to in paragraph 136 (1) shall have a zone of space outside it.

Zone of space for natural lighting.

(2) Where the opening referred to in paragraph 136 (1) is divided into portions, each portion shall have its own zone of space with lines that determine the zones as specified in Figure 8 set out in the Second Schedule.

(3) The zone of space referred to in sub-paragraph (2) shall be limited by a parallel plane passing through and extending from the highest and lowest points of the opening and by parallel planes passing through and extending from the points of the opening that are furthest apart in the lateral direction.

(4) The parallel plane referred to in sub-paragraph (3) may extend from the building at an angle to the plane of the opening.

(5) Where the plane bounding the zone of space referred to in sub-paragraph (2) is not at right angle to the plane of the opening referred to in sub-paragraph (1), the area shall, for the purpose of sub-paragraph (3) be deemed to be—

A x B

Where—

- (a) A is the shortest distance between the planes bounding the top and bottom of the zone of space; and
- (b) B is the shortest distance between the vertical planes bounding the sides of the zone of space.

(6) The available length of a zone of space shall be calculated either as half the sum of the lengths of the vertical planes or as half the sum of the length of the planes passing through the highest and lowest points of opening referred to in paragraph 136 (3) as specified in Figure 9 set out in the Second Schedule.

(7) Where the zone of space referred to in sub-paragraph (2) extends across a road reserve, the building line and the boundary referred to in sub-paragraph (6) (b) and (c) respectively, shall be taken to mean the building line and road boundary of the parcel of land that is situated opposite the construction site.

(8) The available length of a zone of space referred to in sub-paragraph (2), when calculated in accordance with sub-paragraph (6), shall be at least 0.5m when measured to a boundary line, or at least 1m when measured to a building line, and notwithstanding the requirements in sub-paragraphs (9) and (10), shall not exceed 8m.

(9) Where none of the planes bounding a zone of space referred to in sub-paragraph (2) intersects an obstruction on the construction site, the minimum available length of the zone of space shall be that specified in Table 19 set out in the First Schedule.

(10) Where at least one of the planes bounding a zone of space referred to in sub-paragraph (1) intersects an obstruction on the construction site, the minimum available length of the zone of space shall be that specified in Table 19 set out in the First Schedule, where H represents the height of the obstruction above the level of the head of the opening concerned:

Provided that the shortest horizontal distance between the opening and the obstruction shall be at least 1m.

(11) Where a projection from the surface of the wall above an opening referred to in paragraph 136 (1) is likely to significantly reduce the amount of light reaching the opening—

- (a) at least two-thirds of the plan area of the zone of space referred to in sub-paragraph (2) outside the opening shall

have an unrestricted vertical shaft extending upwards from the plane bounding the top of the zone of space; and

- (b) an opaque projection over the zone of space shall not extend to a line that is closer than 1m from any obstruction or lateral boundary intersecting the zone.

138. (1) Where for the purposes of natural ventilation a room has at least one opening—

Natural ventilation.

- (a) the position of an opening in relation to another opening, and to any internal doors to a room shall enable the room to be ventilated; and
- (b) the arrangement and size of the openings in a garage shall ensure that the quantity of noxious fumes or gases in the garage does not exceed a safe limit.

(2) The opening referred to in sub-paragraph (1) shall be—

- (a) an opening or door in an external wall;
- (b) a glazed window which is designed to be opened, in an external wall or in a position in the roof; or
- (c) an opening in the ceiling or at the top of an internal or external wall, connected directly to a vertical ventilating flue.

(3) The total area of an opening referred to in sub-paragraph (2)(a) and (b) shall be at least 5% of the floor area of the room, or 0.2m<sup>2</sup>, whichever is greater.

(4) The total area of an opening referred to in sub-paragraph (2) shall be at least 2% of the floor area of the room.

(6) An air inlet in a non-habitable room shall be provided in the form of a 10mm gap under the door.

(7) The recommended ventilation rates in air changes per hour for a naturally ventilated room shall be as specified in Table 20 set out in the First Schedule.

139. (1) A room with an opening to a roofed and enclosed balcony, gallery or veranda, shall have—

Natural lighting and ventilation of room opening onto an enclosed balcony, gallery, veranda or court.

- (a) a portion of the outer wall of the balcony, gallery or veranda consisting of an opening which is constructed in accordance with paragraph 136(3) and the area of the opening is at least 10% of the combined floor area of the room concerned and the balcony, gallery or veranda;
- (b) a door or other openable areas having an area of at least 5% of the combined floor area of the room concerned and the balcony, gallery or veranda; and
- (c) the portion of the outer wall of the balcony, gallery, or veranda in which the opening is formed provided with a zone of space referred to in paragraph 137.

(2) A room having an opening which opens onto an enclosed and covered, or partially covered court, shall be in accordance with paragraphs 136, 137 and 138 if—

- (a) the cover to the court is adequately translucent;
- (b) the plan area of the cover does not exceed a third of the plan area of the court; or
- (c) the plan area of the cover exceeds a third of the plan area of the court but additional openings from the court of the outside air have been provided to the extent that the total area of all the openings is equal to at least two-thirds of the plan area of the court.

(3) Where the court is to be occupied for any purpose, whether or not any room has an opening which opens onto the court, the cover referred to in sub-paragraph (2) (c) shall be translucent with compliant additional openings and court provided with artificial ventilation.

140. Where in a building lighting is to be installed by a system of artificial lighting, the lighting shall be installed in accordance with—

Artificial lighting.

- (a) ISO 8995-1: (Lighting of Work Places - Part 1: Indoor); and
- (b) ISO 8995-3 (Lighting of Work Places - Part 3: Lighting requirements for safety and security of outdoor work places).

141. (1) Where natural ventilation of a habitable or a non-habitable room cannot be achieved, artificial ventilation may be achieved through mechanical extraction, open flued heating appliances and passive stack ventilation.

Artificial ventilation.

(2) Passive stack ventilation shall be either natural stack, wind assisted by use of ventilation cowls, roof ventilators or mechanical extract ventilation.

(3) Passive draught evaporative cooling shall be applicable in hot arid climates and it shall use pre-cooled air to flush out heated air within a space and where there are limitations in the use of spaces where moisture content is critical.

(4) Where the variants to natural ventilation specified in this paragraph are used, the passive ventilation design shall be justified through an air changes per hour calculation, which shall be prepared by, or under the supervision of, an engineer.

(5) The recommended ventilation rates in air changes per hour referred to in sub-paragraph (4) are in Table 22 set out in the First Schedule.

(6) For the air changes per hour for spaces specified in Table 22 set out in the First Schedule and for other spaces, references can be made to the Institution of Heating and Ventilation Engineers Guide B or the Chartered Institute of Building Services Engineers, Guide B.

(7) Outside air used in an artificial ventilation system shall be introduced in to the system from an inlet positioned to ensure that the air is free from local contamination.

(8) Where it is not possible to position the inlet in accordance with sub-paragraph (7), a filter to reduce contamination of the air to an acceptable level and prevent discharge of dust or fluff that has accumulated in ducts.

(9) The exhaust outlets for air which has been used in an artificial ventilation system shall be located and arranged to ensure that the air does not cause a nuisance nor contaminate air which is likely to be drawn into or ventilate an existing building.

(10) Exhaust outlets or air inlets forming part of an artificial ventilating system shall be protected by a substantial grille or screen, through which a 12mm diameter sphere cannot pass.

(11) Where an artificial ventilation system has been connected to a room—

- (a) designed to be occupied by persons suffering from infectious or contagious diseases;
- (b) containing a water closet pan or urinal;
- (c) used as a sauna;
- (d) used as a darkroom; or
- (e) used as refuse storage room,

air from the room shall not be re circulated to or be permitted to pass into any other room, whether or not the room falls into the same occupancy category, and all the air shall be discharged or exhausted to the outside air.

(12) In a room where heat, dust, gas, vapour or volatile matter is liberated in at least one localised area, the area shall have an extract facility which shall exhaust air from the area at a rate that shall ensure that the heat, dust, gas, vapour or volatile matter, is removed through the facility and discharged to the outside air.

(13) An extract facility shall be constructed so that condensate deposited upon the internal surface of the facility does not run or drip from the surface back onto the area.

(14) An artificial ventilation system serving any parking garage shall be separate from another artificial ventilation system within the building.

(15) Contaminated air exhausted from the garage may be circulated through a transformer or a similar service room in order to dissipate heat and contaminants before passing to the outside air.

(16) The arrangement and size of an air inlet or outlet in a garage shall ensure that the level of noxious or toxic fumes or gases in the garage does not exceed a safe limit.

(17) Where a kitchen contains an extraction facility for extracting heat or vapour, the facility shall, where it is to be subjected to an

atmosphere containing grease in suspension, be fitted with a filter for the air entering the facility in order to prevent grease being carried into the system.

(18) Where a filter cannot be fitted in accordance with sub-paragraph (17), an easily accessible trap or settling chamber shall be installed in the duct leading from the facility.

(19) A provision shall be made at every change in direction of the duct referred to in sub-paragraph (18) for easy inspection and for cleaning of the interior of the duct.

(20) An extraction facility and an artificial ventilation system that is fitted in a kitchen shall be constructed or lined throughout with a non-combustible material.

(21) The extraction facility that is fitted in a kitchen shall not be connected to another extraction facility or artificial ventilation system in the building.

(22) A self-contained artificial ventilation unit installed in the wall of a building where the wall abuts on a public road or place shall be installed and operated to ensure that condensate formed by the operation of the unit is prevented from dripping onto the road or place by means of—

- (a) using a unit which disposes of all condensate by evaporation; or
- (b) arranging for the condensate from the unit to be collected and disposed of into a drain or stormwater drain.

(23) The arrangement and size of an air inlet or outlet in a room which is artificially ventilated shall ensure even and uniform distribution and circulation of air throughout the occupied zone of the room, without the creation of an air velocity that exceeds 0.5m/s.

(24) A room or space which is required to be artificially ventilated and is used for a purpose specified in the first column of Table 21 set out in the First Schedule shall be supplied with outside air at a rate not less than that specified in the second and third columns:

Provided that—

- (a) where the rate of the minimum air requirement is not specified in the second column, the rate given in the third column shall be used;
- (b) where air has been recirculated through an approved filter which removes tobacco smoke particles, or smoking does not take place in the room or space, or in a room or space from which the air has been re-circulated, the rate may be reduced to that given in the second and third columns;
- (c) where airborne toxic substances are released into the room or space concerned, extract ventilation which is able to remove the substances shall be provided;

- (d) in relation to a kitchen or a room containing a bath, shower, water closet pan or urinal, in a dwelling unit, residential building or any room serving a bedroom, borrowed air may be used instead of outside air and the system shall supply the required quantity of air under conditions of intermittent use;
- (e) in relation to a motor vehicle repair garage, darkroom, working area in a commercial dry-cleaning establishment, private or central kitchen in a hotel, motel, resort, dormitory or a similar facility or a wash-room or room containing a water closet pan or urinal located in a building whose occupancy is classified as G1 specified in Table 1 set out in the First Schedule or intended for use by the public, the extract ventilation quantity shall exceed the supply air quantity to ensure negative pressure in the area concerned;
- (f) in relation to a laboratory, a fume cupboard provided shall remove all fumes, gas, vapour or volatile matter likely to be generated in the cupboard shall be provided; and
- (g) in relation to a ticket kiosk situated in a parking garage, the air supply to the kiosk shall be sufficient to create positive pressure within the kiosk.

142. A residential building shall have a means of ventilation and shall have windows that are positioned to directly open to the external air.

Window.

143. (1) A habitable room shall have at least one window or opening directly into the external air, which shall have, for the purpose of daylight, a total area inclusive of frames, equal to at least one-tenth of the floor area of the room.

Area of window.

(2) For a window in a wall abutting on to an open veranda, or immediately beneath a balcony or canopy, the minimum area required under sub-paragraph (1) shall be increased by 5% for each 300mm that the veranda, balcony or canopy, projects from the wall.

(3) In a habitable room, a window shall be of an area of at least 1/20 of the floor area of the room and shall be designed so as to open to the external air, and part of the area so required to open shall be situated at least 1.75m above the floor.

(4) A window which opens from a habitable room on to an enclosed veranda, conservatory or similar place, shall be considered to open directly into the external air—

- (a) if that room and the enclosed verandah, conservatory or similar place, have windows which open directly into the external air; or
- (b) if the window is for a room that has a floor area equivalent to the combined floor area of the habitable room and the enclosed verandah, conservatory or similar place.

144. (1) A window of a habitable room shall be deemed to have direct communication with the external air if opposite to the window,

Space opposite window.



and for its entire area, there is an unobstructed open space distant from—

- (a) the boundary facing the window;
- (b) where the boundary abuts on to a road or on to land, designated as a public open space, the boundary on the opposite side of the road or land; or
- (c) where the window faces an internal open space contained entirely on the same construction site as the building in which the window is situated, the window is installed in the manner specified in Figure 10 set out in the Second Schedule.

(2) If adjoining construction sites are developed to allow for an internal open space, part of which is situated on each construction site, the open space referred to in sub-paragraph (1) may be projected from the wall on the opposite side of that open space.

(3) The distance across an open space opposite a window of a habitable room shall be at least 2.4m.

(4) A balcony or other projection from the face of a wall containing a window of a habitable room shall not intersect the open space referred to in sub-paragraph (1).

145. All back-to-back dwellings shall ensure that every room shall have cross ventilation and adequate lighting.

Back-to-back dwellings.

146. (1) An owner of a building, shall ensure that a habitable room has at least one permanent air vent that is so located as to ensure cross or through ventilation to the external air.

Ventilation of habitable room.

(2) An air vent shall be placed at a height above the floor of at least two-thirds of the average height of the room.

(3) Communication with the external air shall be obtained through a ventilated corridor or passage which has an external wall through which adequate ventilation to the external air is provided.

(4) A flue communicating with a room directly to the external air may be accepted as part of the means of providing through-ventilation:

Provided that in all cases, permanent ventilation shall be provided in an external wall.

147. A pantry shall be ventilated to the external air by an opening fitted with a fly-proof cover to allow adequate flow of air.

Ventilation of pantry.

148. A common staircase or common passage shall be adequately cross ventilated, and for a common staircase, sufficient natural and artificial lighting shall be provided for a common staircase.

Ventilation and lighting of staircase or passage.

149. Where the ventilation of a shop to the external air is restricted to one wall, the width of the shop shall be at least half the depth of the shop and an approved through-ventilation shall be provided.

Ventilation of shop.

150. (1) There shall be no communication between a habitable room and a garage except through a passage which is ventilated. Garage connected to dwelling.
- (2) A garage connected to a habitable room through a passage shall have external permanent through-ventilation by means of vents at a height of 450mm above the floor level and at the ceiling level of the garage.
151. (1) Every part of a building whose occupancy is classified as F4 specified in Table 1 set out in the First Schedule, shall be provided with the ventilation that is required for a habitable room. Ventilation and lighting of building of the warehouse class.
- (2) The lighting of a building whose occupancy is classified as F4 specified in Table 1 set out in the First Schedule shall be in accordance with ISO 8995-1 (Lighting of work places).
152. (1) A public building shall be provided with the lighting in accordance with ISO 8995-1 (Lighting of work places). Lighting and ventilation for a public building.
- (2) In a foyer, shopping mall or other place where large numbers of people are expected to gather, not being a space, which is principally used for the movement of persons, ventilation shall be achieved through natural ventilation by appropriately located openings to external walls with a total area of 2% of the floor area.
- (3) In the public space referred to in sub-paragraph (2), mechanical ventilation shall be designed to provide a ventilation rate of 1litre per second per square metre of the floor area.
153. (1) A system of space heating in a building shall be designed, constructed and installed so as to ensure that a flue, flue pipe or chimney used in the system can remove smoke or noxious gases produced by the system. Design, construction and installation of space heating.
- (2) A flue pipe shall not be—
- (a) designed or installed in such a manner that it may cause a fire hazard to an adjacent material;
  - (b) connected to a shaft or duct which forms part of a ventilation system; and
  - (c) installed in a shaft or duct in which a service which may be adversely affected by heat is situated.
154. (1) A chimney which is within or is attached to a building shall— Chimney.
- (a) be designed and erected of non-combustible materials and in such a manner as not to cause a fire hazard to an adjacent material;
  - (b) not be installed in a shaft or duct in which a service which may be adversely affected by heat is situated; and
  - (c) not consist of combustible material at the timber floor joist, trimmer or roof truss built within 200mm of the inside of the chimney.

(2) Where in a dwelling house or dwelling unit the walls of a chimney are erected of masonry units, the walls shall be of solid masonry, and where the walls are less than 190mm thick, the chimney shall be lined in accordance with sub-paragraph (4):

Provided that the walls shall not be reduced to less than 90mm thick.

(3) Notwithstanding sub-paragraph (2), the thickness of any chimney wall in a building covered by a combustible roof shall be at least 190mm.

(4) Where a chimney is provided with a flue lining, the lining shall extend throughout the full height of the chimney and shall be made of material which can withstand an action of the flue gases and resist, without cracking or softening, the temperatures to which it may be subjected.

(5) Where a chimney has either a laterally unsupported height that exceeds 4m or a laterally unsupported height that exceeds six times its minimum lateral dimension, the chimney shall be designed in accordance with the requirements for the design of structural systems specified in Part VI.

(6) The height of a chimney outlet shall be at least—

(a) 1m above the highest point of contact between the chimney and the roof:

provided that where a roof has an angle of slope on both sides of a ridge of at least 10% from the horizontal and the centre line of the flue of the chimney does not exceed 600mm from the ridge, the height of the chimney outlet shall be at least 600mm above the ridge;

(b) 1m above the highest point of a window or roof light, that opens, or a ventilation inlet situated in a roof or external wall where the horizontal distance from the nearest point of the window, roof light or opening to a vertical line through the centre of the chimney outlet is less than 2.3m; or

(c) 1m above the eaves level in relation to a chimney which does not pass through the roof of a building but is within 1.5m of the nearest wall of the building:

provided that at the gable end of the building the chimney shall extend for at least 600mm above the highest point of the gable end.

155. (1) Every fireplace used for the burning of solid fuel shall have a hearth made of non-combustible material of adequate thickness.

Hearth or  
fireplace for solid  
fuel appliance.

(2) The hearth shall extend for at least 500mm in front of the grate or fire basket and at least 300mm beyond each side of the grate or fire basket.

(3) A timber floor joist or trimmer or other combustible material shall not be built into a hearth.

156. Ventilation design for a space designated for a specialised activity shall be as follows—

Ventilation design for space designated for specialised activity.

- (a) in relation to a school or education institution—
  - (i) provision for ventilation shall be made in accordance with the specifications in Table 23 and Table 24 set out in the First Schedule, except for sanitary accommodation where six air changes per hour are required; and
  - (ii) in a space where noxious fumes may be generated additional ventilation shall require the use of fume cupboards;
- (b) in relation to a hospital, the ventilation needed for various types of accommodation depending on the functional use of the space in accordance ISO 5636-5:2003 (Paper and Board, Determination of Air Permeance and Air Resistance (Medium Range) Gurley Method);
- (c) in relation to a building services plant room, provision shall be made for emergency ventilation to control dispersal of contaminating gas releases and enhanced air conditioning and ventilation;
- (d) in relation to a rest room where smoking is permitted—
  - (i) natural ventilation, for an air supply for the room in accordance with Table 21 set out in the First Schedule and the removal of tobacco smoke particles through local extract ventilation; or
  - (ii) a mechanical ventilation is provided to prevent the recirculation of air contaminated with tobacco smoke and which extracts the smoke-laden air to the outside at a rate of at least 16L per second per person;
- (e) in relation to a commercial kitchen, ventilation designed in accordance with ISO 5636-5:2003 (Paper and Board, Determination of Air Permeance and Air Resistance (Medium Range) Gurley Method); and
- (f) in relation to a car park that is situated below six levels or a multi-storey car park—
  - (i) if the car park is naturally ventilated, the provision of a well distributed permanent natural ventilation which includes openings at each garage level with an aggregate area of at least 5% of the floor area at that level, at least half of which shall be in two opposing walls;
  - (ii) if the car park is mechanically ventilated—
    - (A) the provision of both permanent natural ventilation which includes openings of at least 25% of the floor area and a mechanical ventilation system

which performs at least three air changes per hour;  
or

(B) for basement car parks, the provision of a mechanical ventilation system which performs at least six air changes per hour; and

(iii) for exits and ramps where cars queue inside the building with running engines, provision to ensure a local ventilation rate of at least ten air changes per hour.

157. (1) In every design of a mechanical ventilation or air conditioning plant, provision shall be made to protect the fresh air supplies.

Mechanical ventilation and air-conditioning plant.

(2) Air inlets for ventilation systems shall not be installed where they may draw in contaminated air.

(3) In a design of a mechanical ventilation or air conditioning plant, measures shall be put in place to avoid contamination.

158. All roof spaces shall be adequately ventilated.

Ventilation of roof space.

159. For a public performance space, the reverberation time shall be as specified in Table 25 set out in the First Schedule.

Allowable mid frequencies reverberation time.

160. (1) Natural lighting, natural cooling and natural ventilation shall be provided for a building.

Energy efficiency and thermal comfort.

(2) An electrical appliance in a building shall maximize energy efficiency in accordance with the relevant laws currently in force.

(3) Environmental design concepts shall be followed in the prevention of heat gain and the provision for cooling as part of the overall energy efficiency in a building.

(4) An external glazed area including a window, a wall, an atrium, or a roof, shall mitigate against solar heat gain by use of design devices.

(5) Prevention of heat gain shall include the planning and design of a building layout, landscaping and the choice of appropriate construction materials and sun shading devices of heat gain or loss.

(6) Provision of cooling includes the natural removal of any heat gains from outside, internally generated heat from people, lighting, equipment and any other processes within the building through the various forms of natural ventilation.

(7) Natural lighting shall be provided in a habitable space by allowing for a day light factor as specified in Table 26 set out in the First Schedule.

(8) Where natural lighting cannot be provided for as specified under sub-paragraph (7), energy efficiency lighting fittings shall be installed.

161. An owner designing a building may conform to the sustainable design strategies derived from independent green building certification organisations.
162. The installation and use of renewable energy in a building shall be in accordance with the Energy Act, 2019.
163. (1) A building shall be constructed so as to meet the following requirements regarding indoor air quality—
- (a) good ventilation of both habitable and non-habitable spaces;
  - (b) for artificial ventilation, air intakes located so as to prevent cross contamination from building exhausts;
  - (c) control of use of chemicals on premises to prevent an adverse effect on indoor air quality;
  - (d) the construction material used does not adversely affect the indoor air quality; and
  - (e) the use of low solvent or water-based paints, varnishes and glues.
- (2) Indoor landscaping shall be considered to improve indoor air quality.
164. (1) A storey of a building which is used, or intended to be used, as a building whose occupancy is classified as G1 specified in Table 1 set out in the First Schedule, or for habitation, shall have effective means of lighting and ventilation.
- (2) An owner shall not erect a building that provides back-to-back dwelling unless the owner can provide adequate cross ventilation.
- (3) A dwelling shall be deemed to be a back-to-back dwelling where—
- (a) the dwelling has only one opening situated on only one external wall;
  - (b) the dwelling has at least two parallel walls with no openings; and
  - (c) approved cross-ventilation cannot be achieved in every habitable room in the dwelling.
165. (1) A room used for habitation, or as an office, or as a kitchen shall have natural lighting and ventilation.
- (2) Natural lighting and ventilation shall be provided by means of at least one window which shall be constructed so that—
- (a) the aggregate superficial area of glass in the window is at least one-tenth of the area of the floor of the room;
  - (b) the window can, to an extent at least equal in the aggregate to one-sixteenth of the area of the floor of the room, be

Sustainable building design strategy.

Renewable energy source.  
No. 1 of 2019.

Indoor air quality.

Lighting and ventilation.

Lighting and ventilation for habitation, office or kitchen.

opened in the manner that the top of the opening of each window is at least 2.1m above the level of the floor; and

- (c) the aggregate superficial area of glass in the window of at least one-tenth of the area of the floor of the room, faces directly into the external air.

166. (1) A window shall not be deemed to provide natural lighting and ventilation unless—

Minimum requirements for window.

- (a) it faces into a road that is at least 6m wide;
  - (b) it faces into a space uncovered and unobstructed above the area delineated by the rectangular horizontal plane;
  - (c) it is placed such that if another rectangular plane—
    - (i) the base of which, if equal to and common with the base of the rectangular horizontal plane, is inclined, above the rectangular horizontal plane, at an angle of 71.5° from the horizontal where the window is in a room used for habitation; or
    - (ii) is at an angle of 76° from the horizontal where the window is in a room used for the purposes of an office or as a kitchen;
  - (d) no part of the building, or of any other building protrudes above the plane; or
  - (e) where the window opens on to an area bounded on the side opposite the window by a boundary, the window is placed in the manner specified in Figure 11 set out in the Second Schedule.
- (2) The rectangular horizontal plane shall—
- (a) have an area of at least 21m<sup>2</sup>;
  - (b) have a length at the base of at least 2.3m;
  - (c) have a length of the sides, at right angles to the base, between the wall in which the window is situated and any other wall or building opposite thereto within the boundary, of at least 4.5m;
  - (d) where the window opens on to an area bounded on the side opposite to the window by a boundary, the length of the sides at right angles to the base between the wall in which the window is situated and the boundary, be at least 2.3m; or
  - (e) be at least 2.3m, where the window opens on to an area bounded on the side opposite to the window by a boundary and there is a service lane or road that is less than 4.5m wide adjacent to and parallel with the boundary—
    - (i) the minimum length of the sides at right angles to the base, between the wall in which the window is situated and a line 1.5m beyond the boundary; or

- (ii) where the service lane or road does not exceed 3m wide, between the wall in which the window is situated and a line drawn along the center line of the service lane or road.

(3) In this paragraph—

- (a) “base”, when used in relation to the rectangular horizontal plane, means that side of the rectangular horizontal plane common with the line of the sill of the window;
- (b) “rectangular horizontal plane” means a rectangular plane at the level of the sill of the window having the minimum area and minimum dimensions;
- (c) “window” includes a french window; and
- (d) the sill of a prescribed window shall be deemed to be at a level 1m above the level of the floor of the room for which the window is provided, whether or not the sill is at the level.

167. The distance of a wall of a room used for habitation shall not exceed 9m, measured perpendicularly within the room—

Distance of wall of a room from window.

- (a) from a window which opens directly to the external air;
- (b) from a window which opens on to an enclosed verandah, balcony, conservatory or on to an adjacent room, in accordance with paragraph 139; or
- (c) where the wall is permitted to open on to an un-enclosed verandah, balcony or another un-enclosed place, from the outer edge of the verandah, balcony, conservatory, or enclosed or un-enclosed place, as the case may be.

168. Where a room used, or intended to be used, for habitation, or as an office, has a window which opens on to an enclosed veranda, balcony, conservatory or a similar enclosed place, within the boundary the window shall be deemed to be installed in accordance with this paragraph if—

Windows opening on to enclosed veranda.

- (a) the verandah, balcony, conservatory or similar enclosed place has a window which would be sufficient if it were a window of a room having a floor area equivalent to the aggregate of the areas of the floors; and
- (b) the area of glass and the opening of the window of the room is such that, the window would be sufficient if it was the window of a room having a floor area equivalent to the aggregate of the areas of the floors of the room and the verandah, balcony, conservatory or similar enclosed place.

169. (1) A room shall be naturally lit and well ventilated unless where this cannot be achieved due to the position, level or unsuitable surroundings of the room, in which case such a room shall be provided with artificial ventilation in accordance with paragraph 141.

Mechanical ventilation and artificial lighting of an office.



(2) Where the provision of artificial ventilation in accordance with paragraph 141 cannot be complied with in respect of the room, there shall be provided a mechanical means of ventilation which shall supply fresh air to all parts of the room at a rate of at least five air changes per hour and artificial lighting.

170. (1) Where based on the use of a room, unsuitable surroundings or any other cause, additional ventilation is required, the ventilation may be supplied by means of—

Additional ventilation.

- (a) an aperture or airshaft communicating directly with the open air, having an unobstructed sectional area of at least 0.015m<sup>2</sup>;
- (b) a fanlight which opens to a ventilated lobby or corridor; or
- (c) any other suitable means of ventilation.

(2) A laundry room shall be deemed to be a habitable room.

171. (1) A room containing a soil water fitment or waste fitment shall have a window or lantern light.

Room containing soil water or waste fitment.

(2) A window or lantern light shall be such that—

- (a) the aggregate superficial area of its glass is at least one-tenth of the area of the floor of the room; and
- (b) a part thereof is at least one-tenth of the area of the floor of the room, and can be opened directly into the open air.

(3) The top of that part of a window which is designed to open shall be at least 2.1m above the level of the floor of the room.

(4) A room containing a soil fitment shall not open directly into a room used, or intended to be used, for the manufacture, preparation or storage of food for human consumption.

(5) In this paragraph—

- (a) “soil water fitment” means a water-closet fitment, a trough water-closet or a urinal; and
- (b) “waste water fitment” means a sink, wash hand basin or shower.

#### PART XI—GLAZING AND CLADDING

172. (1) Material used in glazing a building shall be secure and durable and shall be fixed in such a manner and position that shall ensure its capacity to—

Type and fixing of glazing.

- (a) safely sustain wind loads to which it is likely to be subjected;
- (b) not allow penetration of water to the interior of the building; and
- (c) be visually manifest in the case of clear glazing, to any person approaching the glazing.

(2) Glass, plastic and organic coated glass shall have a degree of safety appropriate in relation to—

- (a) the position of the glazed area; and
- (b) the number and likely behaviour pattern of persons expected to be in close proximity to the glazed area.

(3) This paragraph shall be satisfied where the glazing material is selected, fixed and marked in accordance with BS 8000-0:2014: (Workmanship on General Sites, Introduction and General Principles).

173. (1) In a vertical glazing installation, the pane of glass and the fixing of the pane—

Installation of glazing.

- (a) where the pane is to be exposed to the effect of wind, the thickness of the pane in relation to its area shall be in accordance with BS 8000-0:2014 (Workmanship on General Sites, Introduction and General Principles); and
- (b) shall be in the frame in accordance with one of the methods described in BS 8000-0:2014 (Workmanship on General Sites, Introduction and General Principles) and the frame shall be so installed that sustains the total wind load for which the pane was designed.

(2) Despite sub-paragraph (1) (a), the nominal thickness of a pane of glass shall at least that specified in Table 27 and Table 28 set out in the First Schedule.

(3) A pane of glass, not being a door leaf, which is to be installed without the support of a frame, shall be in accordance with BS 8000-0:2014: (Workmanship on General Sites, Introduction and General Principles).

(4) A door leaf made entirely of glass which is not fully contained in a frame shall be in accordance with BS 8000-0:2014: (Workmanship on General Sites, Introduction and General Principles).

(5) Where clear glazing is used and is not likely to be visually manifest to a person approaching it, the glazing shall bear markings which shall render the glazing apparent.

174. (1) A pane of glass installed in a door shall, unless it is a safety glass, not exceed 1m<sup>2</sup> in area and shall have a nominal thickness of at least 6mm.

Safety glazing.

(2) Where the area of the glass referred to in sub-paragraph (1) exceeds 1m<sup>2</sup>, a safety glass or other suitable safety glazing material shall be used.

(3) Where a window is not guarded by a barrier to reduce the possibility of a person coming into contact with the glass installed in the window—

- (a) the sill of the window shall be at a level of at least 300mm from the floor; or
- (b) the glass used in the window shall be designed in accordance with sub-paragraph (1).

(4) Where the window referred to in sub-paragraph (3)(b) is so placed that persons on normal traffic routes are likely to move directly towards the window, the sill shall be at a level of at least 800mm from the floor, or the glass installed in the window shall be designed in accordance with sub-paragraph (1).

(5) A glass installed in a window with an area that exceeds 1m<sup>2</sup> and at a level below 800mm from floor level shall be safety glass.

(6) A window installed in accordance with sub-paragraph (3), shall be installed at a level of 300mm from the floor level.

(7) Where a bath enclosure or shower cubicle is constructed of glass, the glass shall be safety glass.

(8) Glass used in a shop front that has an area exceeding 1m<sup>2</sup> shall be safety glass.

(9) Where glass is used in a wall or balustrade, of a staircase or ramp, and is less than 1.8m above the pitch line of the staircase, the surface of the ramp, or the surface of a landing that forms part of the staircase or ramp, shall be safety glass.

(10) Where a window is located at a level below 1800mm above the pitch line of a staircase or landing, it shall be glazed with safety glass.

175. (1) In order to mitigate risk and enhance safety, the glazing installed at the space referred to in sub-paragraph (2) shall—

Location for safety glazing.

- (a) break safely, in case of breakage upon impact;
- (b) be robust;
- (c) be installed in small panes; or
- (d) be permanently protected.

(2) An owner may install glazing may at the space between a finished floor level and—

- (a) 800mm above the floor level, in an internal, external wall or partition; or
- (b) 1500mm above the floor level, in a door or side panel, close to either edge of the door.

176. (1) Safe breakage shall meet the standards set out in KS 1535-8 (Glass for use in buildings - Part 8: Specification for safety glazing) based on an impact test which requires the result of the impact to be limited to creating—

Safe breakage of glass.

- (a) a small clear opening only, with a limit to the size of the detached particles;
- (b) disintegration, with small detached particles; or
- (c) breakage resulting in separate pieces that are not sharp or pointed.

(2) Glazing material suitable for installation in a critical location, shall satisfy the test requirements of Class C of KS 1535-8 (Glass for use in buildings - Part 8: Specification for safety glazing) or, if it is installed in a door, or in a door side panel which has a pane width exceeding 900mm, the test requirements of Class B of the same standard.

177. Glass thickness and dimension limits for annealed glass and strength of other types of glass shall conform to the thickness and dimension limits specified in Table 27 and Table 28 set out in the First Schedule.

Robustness of glass.

178. (1) A small pane includes an isolated pane, or one of a number of panes contained within glazing bars, traditional leaded lights or copper-lights.

Glazing of small pane.

(2) A small pane shall have a width that does not exceed 250mm and an area not exceeding 0.5m<sup>2</sup> measured between glazing beads or similar fixings.

(3) Annealed glass in a small pane shall be at least 6mm in nominal thickness, except in traditional leaded or copper-lights in which case, a 4mm thick glass is acceptable, when fire resistance is not a factor.

(4) The dimensions and areas of small panes in a typical installation shall be as specified in Figure 12 set out in the Second Schedule.

179. (1) If, as part of a design solution, glazing in a space referred to in paragraph 175 is installed behind permanent screen protection, the screen shall —

Permanent screen protection.

- (a) prevent a sphere of a diameter of 75mm from coming into contact with the glazing; and
- (b) be robust and, if it is intended to protect glazing that forms part of protection from falling, be difficult to climb.

(2) Glazing in a critical location which is afforded permanent screen protection, does not need to be in accordance with the requirements of sub-paragraph (1).

180. (1) Permanent manifestation of a large uninterrupted area of transparent glazing shall only be used when other means of indicating the presence of the glazing which include a mullion, transom, door framing or large pull or push handle, is not used.

Permanent manifestation.

(2) Where manifestation is necessary, it may take the form of broken or solid lines, patterns or company logos at appropriate heights and reasonable intervals.

181. Manifestation shall be required in the installation of glazing in the following circumstances —

Alternative indication of glazing.

- (a) the door which has transparent glazing is less than 400mm in width;
- (b) the door which has transparent glazing with a rail is at a height of between 600mm and 1500mm above a finished ground or floor level;
- (c) a single pane glazed door has substantial framing; or
- (d) a single pane glazed door, which is not framed or which has a very narrow frame, but is provided with large easily seen push or pull, plates or handles.

182. (1) A glass louvre blade shall have a thickness of at least 4mm and the exposed edges shall be polished.

Adjustable glass louvre blade.

(2) The span of a louvre glass blade shall not exceed 600mm.

(3) An adjustable glass louvre blade may only be used on the ground and first floor of a building.

183. (1) Architectural glazing and cladding may take the form of—

Architectural glazing or cladding.

- (a) glass curtain walling;
- (b) rain screen cladding using modular composite panels or fixing system;
- (c) stone cladding using modular composite panels or fixing system;
- (d) aluminium cladding using modular composite panels or fixing system; or
- (e) profile sheeting steel using modular composite panels or fix.

(2) Curtain walling shall be in accordance with EN 13830 (Curtain walling - Product Standard) and EN 13119 (Curtain walling – Terminology).

(3) A glazing unit shall be fitted with suitable sound insulating seals.

(4) An engineer or architect shall certify that architectural glazing and cladding conform to the required standards.

184. (1) The supervising architect or engineer shall receive from the specialist manufacturers, a warranty that a full thermal movement safety check has been carried out related to unbroken areas of glazing.

Thermal safety check.

(2) The responsible architect or engineer shall issue a certificate of guarantee and compliance for the curtain walling system.

185. A glazing gasket, sealing tape, silicones or mastic shall be in accordance with ASTM C7-6-06 (Standard

Gasket sealing.

Specification for Installing Lock-Strip Gaskets and Infill Glazing Materials).

186. (1) A cleaning cradle system shall be in accordance with BS 2830 (Specification for Suspended Access Equipment (Suspended Chairs, Traditional Steeplejack's Seats, Work Cages, Cradles and Platforms) for use in the Building, Engineering Construction, Steeplejack and Cleaning Industries) for a building where a fixed curtain walling system applies.

Cleaning system of curtain walling.

(2) If a cleaning cradle is not used, a glazing unit which is openable and is designed by an architect shall be provided within the curtain walling system.

(3) The maximum dimension from one point of a glazed opening shall not exceed 3m from the next glazed opening along the same façade.

187. (1) An owner shall install curtain walling glazing in a building that exceeds two storeys in height in accordance with BS 6262 (Glazing for buildings).

Glazed curtain walling.

(2) Shop drawings for the glazing referred to in sub-paragraph (1) shall be prepared by the architect, in consultation with a manufacturer who specialises in glazed curtain walling.

188. A mechanical fixing of a glazing system that exceeds 20m in height shall be of stainless steel or another non-corrosive material and installed in accordance with ASTM C7-6 - 06(2020) (Standard Specification for Installing Lock-Strip Gaskets and Infill Glazing Materials).

Glazing system.

189. (1) A sound insulating seal of a glazing unit shall be provided in accordance with—

Sound insulation glazing.

- (a) EN 13022-1 (Glass in building structural sealant glazing Part 1: Glass products for structural sealant glazing systems supported and unsupported monolithic and multiple glazing);
- (b) EN 13022-2 (Glass in building structural sealant glazing Part 2: Assembly rules);
- (c) EN 14188-1 (Joint fillers and sealants - Specification for hot applied sealants); or
- (d) EN 14188-2 (Joint fillers and sealants - Specification for cold applied sealants).

(2) The seal referred to in sub-paragraph (1) shall be installed consistently around a frame, in a manner that ensures a sound reduction of 10dB can be achieved.

(3) Sound insulation shall be provided for by a thick glass or a sealed insulated air gap.

190. A glazing for curtain walling shall be at least 6mm thick.

Glazing thickness.

191. (1) Glazing curtain walling installation shall take into consideration all the climatic aspects based on data from the meteorological department; and ventilation.

Climatic consideration.

(2) The supervising architect and engineer, shall furnish information to a glazing specialist to ensure that the specifications of a material meet the safety requirements and BS 6262 (Glazing for buildings).

192. (1) A stone cladding installation shall be in accordance with BS 8298 (Code of Practice for the Design and Installation of Natural Stone Cladding and Lining) for a building that exceeds two storeys.

Stone cutting wall cladding.

(2) Precast concrete panelling, granite, marble, stone and aluminium profiled sheet steel panelling, shall have a mechanical stainless-steel fixing that exceeds a height of 20m from the ground floor as specified in Table 29 set out in the First Schedule.

193. The Cladding system shall be made of non-combustible material at a height in accordance with requirements of fire safety and fire installation specified in Part XXI.

Fire performance of cladding systems.

#### PART XII—STAIRCASES, LIFTS AND ESCALATORS

194. (1) A building which exceeds one storey in height shall have at least one staircase to access the upper floors.

Provision for staircase.

(2) The main staircase of a building which exceeds four storeys in height, shall be continued to the roof of the building unless a staircase for use as a fire escape is provided.

(3) The main staircase of a building which exceeds one storey in height shall—

- (a) have a clear height of at least 2m;
- (b) have a clear width of at least 900mm in the case of a residential building, or of 1200mm if it is not a residential building;
- (c) have not more than sixteen stairs in a flight without a landing;
- (d) be provided on both sides with handrails which, shall be—
  - (i) if tubular, between 38mm and 50mm in external diameter;
  - (ii) if rectangular, between 40 mm and 50mm wide with an overall depth, or depth to a deep groove, that does not exceed 50mm; and
  - (iii) in any other case, afford to the user thereof, grip that is analogous to that specified in the case of

either a tubular or rectangular handrail, whichever may be more appropriate, having regard to the shape of the section;

- (e) be arranged to provide access to a road or to an open space; and
- (f) if continued to the roof of the building as a means of escape have a door at the roof and the door shall be glazed in the upper panels.

(4) A staircase in a building shall be constructed in accordance with KS ISO 21542 (Building Construction - Accessibility and usability of the built environment).

195. In a building intended for separate occupation the staircase intended for common use shall have natural lighting at each storey above the ground floor and shall be ventilated.

Staircase in buildings intended for separate occupation.

196. Where an owner installs an escalator in a building, the owner shall ensure that a staircase is also constructed in the building.

Staircase constructed in addition to escalator.

197. (1) An unrestricted area shall be provided at each landing of an escalator to accommodate passengers.

Step or landing of escalator.

(2) The unrestricted area referred to in sub-paragraph (1) shall have—

- (a) a width of at least the distance between the handrail centre lines of the escalator; and
- (b) a depth, measured from the end of the balustrade, of at least 2.5m, or at least 2m if the width of the unrestricted area is increased to at least double the distance between the handrail centre lines.

(3) A clear height of at least 2.3m shall have—

- (a) the nosing of a step of an escalator at all points; and
- (b) the unrestricted area referred to in sub-paragraph (1).

198. (1) A building shall have a means of escape in case of an emergency as may be required by the intended use of the building.

Means of escape.

(2) A building which exceeds one storey in height shall, in addition to the main staircase, have an additional staircase which shall be a means of escape in case of an emergency.

199. (1) A building that exceeds one storey in height shall have a staircase that is so designed and constructed as to allow a fireman safe and unobstructed access to all floors of the building in the event of a fire.

Access staircase for firefighter.



(2) In determining the adequate number of access staircases, regard shall be had to the intended use of the building and the size of each floor.

(3) The staircase referred to in sub-paragraph (1) shall be so designed and constructed that, in the event of a fire—

- (a) firemen with equipment, may reach the fire; and
- (b) firemen using the staircase or staircases are adequately protected from fire and smoke.

(4) This paragraph does not apply to a building that does not exceed three storeys in height, that is used, or intended to be used, solely for residential purposes and constitutes a single household unit.

200. A staircase, including a wall, screen, railing or balustrade to the staircase, shall sustain a load to which it is likely to be subjected and shall permit the movement of persons from floor to floor.

Load and dimensions of staircase.

201. (1) Where a pedestrian entrance is provided to a parking space in a building, the entrance shall be so positioned, marked or protected that no pedestrian can walk into the path of a moving vehicle.

Pedestrian entrance to parking space in building.

(2) Sub-paragraph (1) shall not apply to a building classified as H4 specified in Table 1 set out in the First Schedule.

202. A staircase shall be constructed in accordance with the fire and safety requirements specified in Part XXI.

Compliance with fire safety requirements.

203. (1) The headroom at any point on a staircase shall be at least 2m measured vertically from the pitch line, and the width of the staircase, measured to an enclosing wall or balustrade, shall be at least 900 mm.

Dimensional requirement for staircase.

(2) A landing that serves two flights in the same straight line shall—

- (a) have a length of at least 900mm; and
- (b) have a width of not less than that of the flights.

(3) A flight of stairs shall have a vertical rise that does not exceed 3m between landings.

(4) A door shall not open onto a staircase unless the door opens onto a landing and the width of the landing is not less than that of the door.

(5) Where a staircase does not have a solid riser, each tread shall overlap the next lower tread by at least 25mm.

(6) The dimensions of a riser and tread in a flight shall be uniform.

(7) The requirement in sub-paragraph (6) shall not be construed as prohibiting the use of tapered treads in the same flight as treads that are not tapered.

(8) A tapered tread that is not a winder and does not form part of a spiral staircase shall—

- (a) be designed, such that in respect of the part of the tread which is 400mm from the narrower end of the tread, that the treads are equal;
- (b) in the case of a flight containing both tapered and non-tapered treads, be designed, such that the non-tapered treads and have a minimum tread of 125mm;
- (c) be constructed such that the angle between successive risers, measured in the horizontal plane, shall be constant; and
- (d) be installed in accordance with the requirement for variation in a tread where the variation is in each case measured at the same distance from the narrower end of each tread.

(9) A staircase incorporating a winder shall be permitted only in a dwelling house, or within an individual dwelling unit, and at any point on the staircase—

- (a) there shall be not more than three successive winders; and
- (b) the winders shall turn through an angle that does not exceed 90°.

(10) A spiral staircase shall have a width of at least 900 mm and the staircase shall be used as part of an emergency route, or in an occupancy classified as specified in Table 1 set out in the First Schedule.

(11) A staircase that has a winder shall not turn through more than 900 mm.

(12) No more than three winders to be used at any one point.

(13) Sets of winders shall be separated by a staircase.

204. (1) An owner shall ensure that a staircase which contains more than three risers shall be provided by a secure wall, screen, railing or balustrade, which shall be at least 1m high and be erected in a manner that ensures that the wall, screen, railing or balustrade for an occupancy classified as E2, E3, H1, H2 or H3 in Table 1 set out in the First Schedule, shall not have an opening that permits the passage of a 100mm diameter sphere.

Protection for  
users of staircase.

(2) A staircase in an occupancy that is not an occupancy classified as E2, E3, H1, H2, H3 and H4 in Table 1 set out in the First Schedule, shall consist of handrails installed in accordance

with KS ISO 21542 (Building Construction-Accessibility and usability of the built environment).

(3) A staircase which contains more than five risers shall have at least one continuous handrail extending the full length of the flight.

(4) Sub-paragraph (3) shall not apply to a building that is classified as H3 in Table 1 set out in the First Schedule within individual dwelling units of an occupancy classified as H4 in Table 1.

(5) A handrail shall be—

- (a) fixed to the wall, screen, railing or balustrade at a height of between 850 mm and 1m measured vertically from the pitch line to the upper surface of the handrail; and
- (b) be of a design and fixed in such a manner that ensures there are no obstructions on, above or close to it which may obstruct the movement of any hand moving along it.

(6) A staircase which does not exceed 1.1m wide shall have a handrail on at least one side and where the width of a staircase exceeds 1.1m, a handrail shall be provided on both sides of the staircase.

205. (1) In a staircase, the stairs shall all have the same risers and the same treads in accordance with the dimensions specified in sub-paragraph (3).

Steepness of riser and tread.

(2) The categories of staircases are—

- (a) private, which are intended to be used for only one dwelling;
- (b) institutional and assembly, which serve a place where a substantial number of people gather; and
- (c) any others, which are used, or intended to be used, in all other buildings.

(3) An indication of the practical limits for a riser and a tread, for the categories of stairs specified in sub-paragraph (2) are—

- (a) for a private staircase, where a riser is—
  - (i) between 155mm and 180mm, the tread shall be between 250mm and 265mm; or
  - (ii) between 165 mm and 180mm, the tread shall be between 250mm and 300 mm;
- (b) for an institutional and assembly staircase, where a riser is between 135 mm and 180 mm, the tread shall be between 280 mm and 340 mm; and

- (c) for any other staircase, where a riser is between 150mm and 180mm, the tread shall be between 250 mm and 320 mm.

(4) The normal relationship between the dimensions of the rise and tread is twice the rise plus the tread (2R+T) which shall be between 550 mm and 700 mm, the most comfortable being 640 mm + or – 20 mm.

(5) A staircase shall have level treads.

(6) Where a staircase has open risers, the treads shall overlap each other by at least 16 mm and shall be constructed so that a 100 mm diameter sphere cannot pass through the open risers.

206. (1) A headroom of 2m shall be provided on the access between levels.

Headroom on staircase.

(2) For a loft conversion, where there is not enough space to achieve the height specified in sub-paragraph (1), the headroom may have its height measured at the centre of the staircase as 1.9m and reduced to 1.8 m at the side of the stair.

207. (1) The width of an auxiliary staircase shall be at least 900mm.

Width of flight of staircase.

(2) A designer shall ensure that a staircase which—

- (a) forms part of a means of escape, is constructed in accordance with Part XXI; and  
(b) provides access for persons living with disabilities.

(3) A staircase in a public building which is wider than 1800 mm shall be divided into flights which are not wider than 1800 mm.

208. (1) A number of risers in a flight of a staircase shall not exceed 16.

Length of flight of staircase.

(2) Despite paragraph (1), a staircase that has more than 36 risers in consecutive flights shall make at least one change of direction of at least 30° between flights.

209. (1) A landing on a staircase shall be provided at the top and bottom of every flight.

Landing on staircase.

(2) The width and length of a landing shall be at least the smallest width of the flight.

(3) A landing may include part of the floor of the building.

(4) A landing shall be clear of permanent obstruction.

(5) A door may swing across a landing at the bottom of a flight but only if it will leave a clear space of at least 400mm across the full width of the flight.

(6) A door, cupboard or duct may open in the manner referred to in sub-paragraph (5) over a landing at the top of a flight.

(7) A landing shall be level unless it is formed by the ground at the top or bottom of a flight.

(8) The maximum slope of the landing referred to in sub-paragraph (8) shall be 1 in 20, provided that the ground is paved or otherwise made firm.

210. For a staircase with tapered treads, the treads shall be measured as follows—

Staircase with tapered treads.

(a) if the width of a flight is less than 1m, the tread shall be measured from the middle; and

(b) if the width of a flight is at least 1m, the tread shall be 270 mm from either side of the flight.

211. (1) Where a fixed ladder is installed in a building, the ladder shall be used for access to only one habitable room.

Fixed ladder.

(2) A retractable ladder shall not be used as a means of escape.

212. (1) A staircase shall have handrails on both sides in accordance with KS ISO 21542 (Building Construction-Accessibility and usability of the built environment).

Handrail for a staircase.

(2) A handrail shall be provided beside the two bottom stairs in a public building where the staircase is intended to be used by persons living with disabilities.

(3) The height of a handrail shall be between 850mm and 1000mm measured to the top of the handrail from the pitch line or floor, and may form the top of a guarding if the heights are matched.

(4) A flight or a landing shall be guarded at the sides in—

(a) a dwelling, when there is a drop that exceeds 600 mm; and

(b) a building that is not a dwelling, when there are at least two risers.

(5) The guarding to a flight of a staircase which is likely to be used by children under eight years, shall be constructed so as to prevent a child from being held fast by the guarding.

(6) The construction of the staircase referred to in sub-paragraph (5) shall be such that a sphere of a diameter of at least 100mm cannot pass through an opening in the guarding, and a child is not able to climb the guarding.

(7) The guarding referred to in this paragraph shall withstand a horizontal force.

213. (1) The construction and position of a lift in a building, shall be in accordance with the requirements of this paragraph. Enclosure and position of lift and motor room.
- (2) A motor room shall be impervious to moisture and fully enclosed with incombustible material and separated from the lift well, except, for an opening necessary for the passage of the requisite wires and cables.
- (3) In an enclosed lift well, a smoke outlet to the open air shall be provided, at or near the head of the shaft.
- (4) The smoke outlet referred to in sub-paragraph (3) shall be at least 0.04 m<sup>2</sup> in area and fitted with an openwork metal grille or widely spaced louvers, water and shall be water and vermin proof.
- (5) A motor room, shall be cross-ventilated and, shall have an approved window space, which shall open directly into the external air.
- (6) A motor room shall be of such a size as to permit an unobstructed circulating passage between the lift motor equipment and the external walls.
- (7) In a residential or public building, where a floor exceeds 14m above the adjacent ground level, and there is only one stairwell, the lift well shall—
- (a) be wholly enclosed in fire-resistant material that has a notional fire resistance equal to that of the walls of the building in which the lift is installed; and
  - (b) have a thickness of at least 100 mm, and the doors to the opening shall be of solid timber, steel shielded gates or any other material with a resistance to fire of not less than half of that required for the walls enclosing the lift well.
- (8) In a building that does not exceed 14 m in height, if the motor room is situated at the bottom of the lift well, the lift well may be within the stairwell if protected by solid fire-resistant enclosures and solid timber type doors or steel shielded gates.
- (9) If the motor room is situated at the head of a lift well, the enclosure to the lift, may consist of metal grills with collapsible lattice gates at the openings.
214. A lift and a hoist shall be installed and maintained in accordance with the Occupational Safety and Health Act, 2007. Compliance with No. 15 of 2007.
215. A building comprising of at least six storeys above the ground level shall have at least one passenger lift. Provision of a lift.
216. The installation and operation of a passenger lift, or a service or good lift shall be in accordance with KS ISO 4190 Installation and operation of a lift.

(Lift (Elevator) installation) and KS 2169-1 (Safety rules for the construction and installation of lifts - Part 1: Electric lifts).

217. The installation and operation of an escalator shall be in accordance with KS 2291-1 (Safety escalators and moving walls - Part 1: construction and installation). Provision of an escalator.

218. The minimum dimensions of a lift well, entrance pit, machine room or headroom shall be as in Table 30 set out in the First Schedule. Dimensions for lift installation.

219. (1) Each lift well shall meet the structural design requirements to carry the lift car and the maximum load safely. Lift well enclosure.

(2) The dimensions in Table 30 set out in the First Schedule for a lift well enclosure shall be applied together with the dimensions of a lift well enclosure specified in Figure 13 set out in the Second Schedule.

220. (1) Access to an inspection door, emergency door or inspection trap, to a lift well, shall not be permitted. Lift well inspection, emergency door and inspection trap.

(2) Where an inspection door is provided, it shall have a minimum height of 1400mm and a minimum width of 600mm.

(3) Where an emergency door is provided, it shall have a minimum height of 1.8 m and a minimum width of 500mm, and shall—

- (a) be located in a position readily accessible to a rescuer; and
- (b) bear on its outside face a notice in English and in Kiswahili in letters and characters that are at least 25mm high as follows—
  - (i) “DANGER” and “HATARI”;
  - (ii) “UNAUTHORISED ACCESS PROHIBITED” and “HAKUNA KUINGIA BILA IDHINI”; and
  - (iii) “LIFT WELL RESCUE DOOR, IF OPEN CLOSE AND LOCK THIS DOOR” and “MLANGO WA KUOKOLEA KISIMA CHA LIFTI, IKIWA WAZI, FUNGA MLANGO HUU”.

(4) Where an inspection trap is provided, it shall have a maximum height of 500mm and a maximum width of 500 mm.

(5) When the distance between consecutive landing door sills exceeds 11m, an intermediate emergency door shall be provided, such that the distance between the sills does not exceed 11m.

(6) Where an inspection door, emergency door or an inspection trap is provided, it shall be imperforated and shall not open towards the interior of the lift well.

(7) Where an inspection door, emergency door or an inspection trap is provided, it shall have a key-operated lock, which is closable and lockable without a key.

(8) Where an inspection door or an emergency door is provided; it shall be openable from the inside of the well without a key, even when locked.

221. (1) A lift well shall be suitably ventilated.

Ventilation of lift well.

(2) The ventilation of a lift well shall not be used to provide ventilation to another room other than a room used for the service of the lift.

(3) An opening shall be made at the top of a lift well, with a minimum area of 1% of the area of the horizontal cross section of the well, ventilating to the open air either directly, via a duct, the machine room or the pulley room:

Provided that the opening shall be at least 0.15 m<sup>2</sup> net free area.

222. (1) The structure of a lift well shall support any load which may be applied by the machine, by the guides at the moment of safety gear operation, or in the case of off-centring of the load in a car, by the action of buffers, or the load which may be applied by an anti-rebound device.

Wall, floor or ceiling of lift well.

(2) In the case of a hydraulic lift, the structure of a lift well shall support any loads which may be applied—

- (a) by the machine, the jacks and guides; or
- (b) by the buffers, safety gear, clamping device or other devices, at the moment of application and due to off-centring of loads in the car.

(3) The walls, floor and ceiling of a lift well shall be constructed of non-combustible and durable materials which do not attract or retain dust and shall have sufficient structural strength.

(4) The inner surface of all the walls of a lift well shall form a continuous vertical surface composed of smooth and hard elements unless the surface is inaccessible from the top of a car via its adjacent installation as a counterweight and structural support.

223. (1) A wall of the lift well facing the car entrance shall—

Construction of wall of lift well facing car entrance.

- (a) have an inner surface of the wall form a continuous vertical surface composed of smooth and hard elements;
- (b) have a smooth surface which extends at least 25 mm on both sides beyond the full car entrance width; and



(c) not be plaster faced or have glass walls.

(2) Where it is not practicable to provide a continuous smooth surface as required under sub-paragraph (1), a projection that exceeds 5 mm shall be—

- (a) connected to the lintel of the door opening below; or
- (b) extended downward and splayed, on its underside, to an angle of not less than 75° from the horizontal plane for a distance of at least 20 mm, by means of metal plates, concrete or other similar material.

224. (1) A lift well shall not be situated above a space that is accessible to persons.

Protection of space located below car or counterweight.

(2) If an accessible space exists beneath a car or a counterweight, the base of the pit shall be designed for an imposed load of at least 5kN/m<sup>2</sup>, and—

- (a) there shall be installed below the counterweight buffer a solid pier extending down to solid ground; or
- (b) the counterweight shall be equipped with safety gear.

225. (1) There shall be a partition between the moving parts (car or counterweight) of different lifts or service lifts in the lower part of a lift well.

Well containing car and counterweight belonging to several lifts or service lifts.

(2) The partition referred to in sub-paragraph (1) shall extend from the floor of the lift pit to a height of at least 2.5 m above the floor of the pit, and across the whole depth of the lift well.

(3) If the horizontal distance between the edge of a car roof and a moving part (car or counterweight) of an adjacent lift or service lift is less than 300mm, the partition referred to in sub-paragraph (1) shall be extended through the full height of the lift well.

226. (1) The lower part of a lift well shall consist of a lift pit, the bottom of which shall be smooth and approximately level, except for a base for a buffer, guide, jack, or for a water drainage device.

Lift well.

(2) After building in a guide fixing, buffer, or a grid, a lift pit shall be impervious to infiltration of water.

(3) An access door shall be provided to the lift pit if the pit depth exceeds 1.6m and if the layout of the building so permits.

(4) Where an access door referred to in sub-paragraph (3) is provided, it shall—

- (a) have a minimum height of 1.4 m and a minimum width of 600 mm;
- (b) bear on its outside face a notice in English and in Kiswahili in letters and characters that are at least 25 mm high as follows—

- (i) “DANGER” and “HATARI”;
- (ii) “UNAUTHORIZED ACCESS PROHIBITED” and “HAKUNA KUINGIA BILA IDHINI”; and
- (iii) “IF LEFT OPEN, CLOSE AND LOCK THIS DOOR” and “IKIWA WAZI, FUNGA MLANGO HUU”.

(5) If there is no other access to a lift pit, a permanent means of access, with suitable hand holds at an appropriate height above the sill shall be provided inside a lift well and they shall be easily accessible from the landing door, to permit maintenance personnel to descend safely to the floor of the pit.

(6) The means of access referred to in sub-paragraph (5) shall not project into the clear running space of any lift equipment.

(7) A lift well shall be exclusively used for a lift.

(8) A landing entrance shall incorporate a sill of sufficient strength to withstand the passage of loads being introduced into a car.

(9) A slight counter slope shall be provided in front of each landing sill to avoid water from washing, sprinkling, draining or entering into a well.

(10) On the outside of a well at each landing level, as near as practical to the landing door or, where there are at least two adjoining lifts, the landing door of one in every two lifts, there shall be displayed a notice in English and Kiswahili and in letters and characters that are at least 25 mm high as follows—

“WHEN THERE IS A FIRE DO NOT USE THE LIFT” and “WAKATI KUNA MOTO USITUMIE LIFT”.

227. (1) A machine operating a lift and its associated equipment shall be in a room that comprises of solid walls, a ceiling and a door or trap.

Machine or pulley room.

(2) A machine room or a pulley room, shall be used only for accommodating the equipment necessary for the operation of a lift.

(3) A machine room or a pulley room, may be provided with—

- (a) machines for service lifts and escalators;
- (b) equipment for air-conditioning or ventilating the room; and
- (c) such fire service installations and equipment as may be required.

(4) Despite sub-paragraph (3)(c), a sprinkler system, shall not be fitted in a machine or pulley room.

(5) A machine room or a pulley room shall be placed above a well.

228. (1) Access to a machine room or a pulley room shall be from a common area.

Access to machine or pulley room.

(2) Clear and safe access to a machine room or pulley room shall be maintained at all times and in all circumstances.

(3) The access to a machine room or pulley room and an entrance shall be at least 2m high provided that a door sill or an edge with a height not exceeding 400 mm is permitted.

(4) A person may access a machine room or pulley room from a staircase if the difference in levels so requires.

(5) If it is impractical to install the staircase referred to in sub-paragraph (4), a ladder may be used.

(6) The ladder referred to in sub-paragraph (5) shall—

- (a) be permanently fixed;
- (b) if more than 2m in height, be fitted with safety hoops or other suitable fall arrest system; and
- (c) if adjacent to the top end thereof, have a platform with railings and one or more hand holds within easy reach.

(7) A crane or other similar means shall be provided for the hoisting of heavy equipment during erection and, if need be, its replacement, so that this can be done safely, especially avoiding handling on a staircase.

229. (1) A machine room or a pulley room shall be so constructed as to withstand the loads and forces to which they will usually be subjected.

Structural strength and floor surface of machine room or pulley room.

(2) A machine room or a pulley room shall be constructed using durable material that does not attract or retain dust.

(3) A floor finish of a machine room or a pulley room shall be made of non-slip material.

230. (1) The dimensions of a machine room or pulley room shall be sufficient to permit easy and safe access for maintenance personnel to all components and the electrical equipment in the machine room.

Dimensions of machine room or pulley room.

(2) The clear height of a machine room or pulley room shall be at least 2.1m to allow for movement or working.

(3) The height referred to in sub-paragraph (2) shall be measured from the underside of the structural roof beams to—

- (a) the floor of the access area; or
- (b) the floor of the working area.

(4) The height under the roof of a machine room or pulley room shall be at least 1.5 m.

(5) Where a machine room or pulley room floor comprises a number of levels, differing by more than 500mm, a staircase with a guard rail shall be provided.

(6) Where the floor of a machine room or pulley room has a recess that exceeds 500mm deep and does not exceed 500mm wide, or has a channel, the floor shall be covered with a steel chequer plate of 4 mm thick, or other non-corrosive material which support the weight of maintenance personnel.

231.(1) An access door to a machine room or pulley room shall have a minimum width of 600mm and a minimum height of 1.8 m for a machine room, and a minimum height of 1.4m for a pulley room.

Door or trap door to machine room or pulley room.

(2) An access door to a machine room or pulley room shall not open towards the inside of the room.

(3) An access door or trap door shall have a clear passage of at least 800mm x 800mm, and shall be counter-balanced.

(4) A trap door, when closed, shall support two persons, and shall resist a vertical force of 2kN at any position, without permanent deformation.

(5) A trap door shall not open downwards.

(6) A hinge installed on a trap door shall be of a type which cannot be unhooked.

(7) An access door or a trap door to a machine room or a pulley room shall—

(a) be fitted with locks which can be opened without a key from inside the room; and

(b) bear on the outside face a notice in English and Kiswahili and in letters and characters that are at least 25mm high as follows—

(i) “DANGER” and “HATARI”;

(ii) “UNAUTHORIZED ACCESS PROHIBITED” and “HAKUNA KUINGIA BILA IDHINI”; and

(iii) “MACHINE ROOM, IF LEFT OPEN CLOSE AND LOCK THIS DOOR” and “CHUMBA CHA MASHINE, IKIWA IMEACHWA WAZI, FUNGA MLANGO HUU”.

(8) A trap door shall only be used for access of material and shall only be locked from the inside.

232. (1) The dimensions of any other opening in the slab or floor of a machine room or pulley room shall be reduced to a minimum.

Other opening in machine room or pulley room.

(2) A protective cap which projects at least 50 mm above a slab, or a finished floor, of a machine room or a pulley room, shall be installed so as to prevent objects from falling through openings situated above a well, including those for electric cables.

233. At least one metal support or hook, with a safe working load notice, as appropriate, shall be provided in a machine room ceiling, or on beams conveniently positioned so as to permit the hoisting of heavy equipment during installation and, if need be, the replacement of the machine operating a lift.

Handling of equipment in machine room.

234. (1) A machine operating a lift and its ancillary equipment shall be accommodated in an enclosure within a lift well, or in a separate machine room.

Machine room enclosure.

(2) For a service lift of a rated load of at least 150 Kg, the space floor area of the machine operating the lift shall be at least 1.5 m x 1.5 m, and the clear height shall be at least 1.2 m.

(3) For a service lift of a rated load below 150 Kg, the space depth of the machine operating the lift shall not exceed 600 mm and the clear height shall be at least 800 mm.

(4) A machine room shall be weather-proof, dry safe and accessible by maintenance personnel.

(5) For a service lift of a rated load of at least 150 Kg, the floor space of the machine operating the lift shall have adequate strength at every point to withstand the load of maintenance personnel and equipment.

(6) For a service lift of a rated load below 150 Kg, the following requirements shall apply—

- (a) the maintenance personnel shall be able to reach every part of the equipment inside the space of the machine operating the lift while standing outside the space; and
- (b) a rigid partition or wire mesh shall be provided to prevent an object from falling down into the lift well from the space of the machine which operates the lift.

(7) A machine room shall be accessible for maintenance and inspection purposes.

(8) An access door to a machine room shall—

- (a) for a service lift of a rated load below 150Kg, be at least 800mm in height and have a width of 900mm or the full width of the space of the machine operating the lift, whichever is less;
- (b) for a service lift of a rated load of at least 150Kg, be at least 1m in height;
- (c) have a width of at least 1.2m;
- (d) face the machine operating the lift and its ancillary equipment to allow installation and maintenance work;
- (e) be lockable; and
- (f) bear on its outside face a notice in English and Kiswahili and in letters and characters that are at least 25mm high as follows—
  - (i) “DANGER” and “HATARI”;
  - (ii) “UNAUTHORIZED ACCESS PROHIBITED” and “HAKUNA KUINGIA BILA IDHINI”; and
  - (iii) “MACHINE ROOM, IF LEFT OPEN CLOSE AND LOCK THIS DOOR” and “CHUMBA CHA MASHINE, IKIWA IMEACHWA WAZI, FUNGA MLANGO HUU”.

(9) A machine room shall not be used for purposes other than for those related to the lift.

(10) A machine room shall not contain ducts, cables or devices other than those for the lift.

235. (1) Where a separate machine room or a separate driving and return station is provided, the machines and associated equipment shall be in a special room which comprises of solid walls, ceilings and a trap door.

Machine room or driving and return station.

(2) A separate machine room or a separate driving and return station, shall be used for accommodating the equipment necessary for the operation of a lift and an escalator.

(3) A separate machine room or a separate driving and return station, may be provided with—

- (a) a machine for operating a lift or a service lift;
- (b) equipment for air-conditioning or ventilating the machine room or return station; and
- (c) a fire service installation and equipment as may be required by the approving authority.

(4) Despite sub-paragraph (3)(c), a sprinkler system, shall not be fitted in a separate machine room, or a separate driving and return station.

(5) A separate machine room or a separate driving and return station, shall be of sufficient size to permit easy and safe access for maintenance personnel to all the components, especially the electrical equipment and the clear height of the room or station shall be at least 2.1m.

(6) A person may access a separate machine or separate driving and return station from a staircase if the difference in levels so requires.

(7) If it is impractical to install the staircase referred to in sub-paragraph (6), a ladder may be used.

(8) The ladder referred to in sub-paragraph (7) shall—

- (a) be permanently fixed;
- (b) if more than 2m in height, be fitted with safety hoops or other suitable arrest system; and
- (c) if adjacent to the top end thereof, have a platform with railings and at least one hand hold within easy reach.

(9) An access door or inspection trap to a separate machine room, or separate driving and return station, shall bear on their outside face a notice in English and Kiswahili and in letters and characters that are at least 25 mm as follows—

- (a) “DANGER” and “HATARI”;
- (b) “UNAUTHORIZED ACCESS PROHIBITED” and “HAKUNA KUINGIA BILA IDHINI”; and

- (c) “MACHINE ROOM, IF LEFT OPEN CLOSE AND LOCK THIS DOOR” and “CHUMBA CHA MASHINE, IKIWA IMEACHWA WAZI, FUNGA MLANGO HUU”.

236. (1) Where a part of a building obstructs, or may obstruct, a passenger riding on an escalator, at floor intersections or on crisscross escalators, protection against injury to the passenger by the use of imperforate triangular guards shall be provided. Obstruction.

(2) The horizontal distance between the outer edge of a handrail of an escalator, and a wall, or any part of a building likely to cause an obstruction, shall be at least 80 mm.

(3) There shall be marked conspicuously on a hoist or lift the maximum working load which it can safely carry and a load exceeding the maximum working load shall not be carried on the hoist or lift.

#### PART XIII—ROOFS

237. (1) The roof of a building shall be constructed in such a manner as to— Construction of roof.

- (a) resist any force it is likely to be subjected to;
- (b) be durable and waterproof;
- (c) prevent the accumulation of rainwater on the surface of the roof;
- (d) provide adequate height, as part of the roof and ceiling assembly, in a room immediately below the assembly; and
- (e) reduce the heat island effect and heat stress in the building and cool it by use of approved reflective coating technology.

(2) A roofing structure design shall be prepared by an engineer or architect.

238. (1) A timber roof shall be designed and installed in accordance with KS EN 1995 (Design of Timber Structures) Design and installation of structural roof component.

(2) The design of timber members for roof construction shall be in accordance with KS EN 1995 (Design of timber structures), except specification for softwood timber grades which shall be in accordance with KS 771 (Specification for softwood timber grades for structural use).

(3) Timber for structural roof components shall—

- (a) be of a quality and strength sufficient for the intended use, and shall be well-seasoned and free from rot, beetle or other vermin;
- (b) not contain large loose knots, splits or other defects to such an extent, and so situated, that it renders the timber member inadequate in strength, stiffness or durability; and
- (c) be treated against infestation.

(4) A timber roof truss and other roof framing shall have all joints accurately cut, securely made with approved material and be fitted so that the component parts are drawn tightly together in such a manner that—

- (a) where the timber is jointed in its length, it shall be by means of an approved tensile or compressive joint;
- (b) joints in adjacent truss members, purlins and rafters shall be staggered;
- (c) a trussed roof shall have approved bracing to prevent buckling of rafters and tie; and
- (d) a member of a truss shall have a length that does not exceed sixty times its least lateral dimensions.

(5) A timber roof shall be designed in such a manner that it does not impose thrust on the walls, piers or other means of support, unless a provision is made in the design and construction of the wall, pier or other means of support to take all the imposed outward thrust due to vertical and horizontal loads.

(6) A timber roof truss, rafter, beam or wall plate shall be fastened down and connected to its means of support by built-in, or cast-in, galvanized steel strap or steel wire, bolts or other approved means.

(7) Where steel or aluminium is used for a roof structure, the design of the roof structure shall be in accordance with—

- (a) KS EN 1993 (Design of steel structures) for steel; or
- (b) KS EN 1999 (Design of aluminium structures) for aluminium.

239. (1) Where the timber used for structural roof components includes cypress or pine, for the general structural grade, or for the construction of common rafters the sizes in Table 31 set out in the First Schedule may be used.

Timber used for roof component.

(2) Where the timber used for structural roof components includes cypress or pine, for the general structural grade, or for the construction of purlins and battens the sizes in Table 32 set out in the First Schedule may be used.

(3) Where the timber used for structural roof components includes cypress or pine, for the general structural grade, or for the construction of ceiling joists, the sizes in Table 33 set out in the First Schedule may be used.

240. Where a roof or ceiling assembly has light fittings or other components which penetrate the ceiling assembly, the degree of non-combustibility of the roof or assembly shall be in accordance with Part XXI.

Degree of non-combustibility of roof.

241. (1) Where the design of a roof requires waterproofing, an owner shall ensure the roof is waterproofed in accordance with—

Waterproofing.



- (a) KS 2259 (Integral cement waterproofing Compounds – Specification);
- (b) ASTM C208 (Standard Specification for Cellulosic Fiber Insulating Board);
- (c) ASTM C276 (Standard Specification for Mineral Wool Roof Insulation Board);
- (d) ASTM D41/D41M (Standard Specification for Asphalt Primer Used in Roofing, Damp proofing and Waterproofing);
- (e) ASTM D173/D173M (Standard Specification for Bitumen-Saturated Cotton Fabrics Used in Roofing and Waterproofing);
- (f) ASTM D226/D226M (Standard Specification for Asphalt Saturated Organic Felt Used in Roofing and Waterproofing);
- (g) ASTM D449/449M – 03 (Standard Specification for Asphalt used in Damp Proofing and Waterproofing);
- (h) ASTM D517 (Standard Specification for Asphalt Plank)
- (i) ASTM D1327/D1327M (Standard Specification for Bitumen-Saturated Woven Burlap Fabrics Used in Roofing and Waterproofing);
- (j) ASTM D1668/D1668M (Standard Specification for Glass Fabrics (Woven and Treated) for Roofing and Waterproofing);
- (k) ASTM D2178/D2178M (Standard Specification for Asphalt Glass Felt Used in Roofing and Waterproofing);
- (l) ASTM D4586/D4586M (Asphalt Roof Cement, Asbestos Free); or
- (m) EN 13967 (Flexible Sheets for waterproofing – Plastic and rubber damp proof sheets including plastic and rubber basement tanking sheet – Definitions and characteristics).

(2) For the purpose of the runoff of water, a roof with a covering of one of the materials in Table 4 set out in the First Schedule shall be constructed to a slope of at least the minimum angle of slope given in column 3 of Table 4 and the covering shall, where applicable, have an end lap, the minimum of which is as specified in column 4 or 5, as the case may be.

(3) When a metal roof tile is used over an existing roof, the existing roof slope may be retained.

242. Flashing shall be used where a roof abuts against a wall or around a projection through a roof covering and any other place.

Flashing.

243. (1) Where a nominally flat roof of boarded or concrete construction is used, it shall have an impervious surface and be laid to a fall of not less than 1 in 50.

Flat roof.

(2) Where a parapet wall abuts a covered flat roof, the edges of the water-proofing material shall be turned up underneath corrosion proof metal cover flashing which is tucked into the horizontal joint of the parapet wall at least 450 mm above the roof level.

(3) Where any nominally flat roof is to be subjected to pedestrian or vehicular traffic, a waterproofing membrane applied to it shall be protected against damage.

#### PART XIV—WATER SERVICES, DRAINAGE, WASTE DISPOSAL AND STORM WATER DRAINAGE

244. (1) Construction works shall provide for rainwater harvesting.

Water management.

(2) An owner of a building may install a grey water management system designed to separate grey water, from wash hand basins and sinks from waste.

245. (1) An owner shall ensure that a suitable means of disposal of water borne sewage is available and shall provide a drainage installation.

Compulsory drainage of building.

(2) Where there is no means of disposal, sewage shall be disposed of in accordance with Part XVIII.

(3) Where a sewer is, or becomes available, for the drainage of a building, the owner of the building shall, at their cost, lay, alter or extend the drain serving the building to terminate at a location and level, for the connection to the sewer.

(4) In the case of an existing building, the approving authority shall serve a notice in writing to the owner, stating the period within which the connection contemplated in this paragraph shall be made.

(5) Where a connecting sewer has been provided to a construction site, the owner shall cause the sewage discharged from a building on the construction site to be conveyed by a drain to the connecting sewer.

(6) Where the owner of a building fails to lay, alter or extend a drain in accordance with sub-paragraph (5), the approving authority, may in public interest, and upon issuing a notice of not less than fourteen days to the owner, alter or extend the drain and recover the costs incurred from the owner.

246. (1) A drainage installation in a building shall be designed and constructed in such a manner as to ensure that—

Design of drainage installation.

- (a) an adequate number of sanitary fixtures as in Table 34, Table 35, Table 36, Table 37, Table 38 and Table 23 set out in the First Schedule is provided in relation to the occupancy and class of occupancy of a building;
- (b) the drainage installation carries the design hydraulic load;
- (c) the drainage installation discharges into any common drain, connecting sewer or sewer provided to accept the discharge;

- (d) a component or material used in the installation is watertight;
  - (e) nuisance, or danger to health, is not caused as a result of the operation of the installation;
  - (f) a drain in the drainage installation is—
    - (i) of the strength specified in Table 24 and Table 39 set out in the First Schedule, having regard to the manner in which it is bedded or supported;
    - (ii) sustains the loads and forces it may be subjected to as shown in Table 39 set out in the First Schedule; and
    - (iii) protected against any damage;
  - (g) a sanitary fixture is accessible to the users; and
  - (h) the inspection, cleaning and maintenance required, may be performed through the means of access provided.
- (2) The requirements of paragraph (1) shall be considered to be satisfied where an installation—
- (a) is the subject of a design prepared by an engineer; or
  - (b) is in accordance with paragraph 273.

247. (1) A person shall not cause or permit sewage discharged from a sanitary fixture to enter—

- (a) a storm-water drain, storm-water sewer, an excavated or constructed watercourse;
- (b) a river, stream or natural watercourse, whether ordinarily dry or otherwise; or
- (c) a road or another construction site.

(2) A person shall not cause or permit storm-water to enter a sewer installation.

(3) A person shall not discharge or cause the discharge of the water from a swimming pool, fountain or reservoir into a public road, public place or into a construction site other than the construction site upon which the swimming pool, fountain or reservoir is situated.

248. (1) Where a soil fixture is permanently disconnected from a soil pipe, or where a soil pipe is permanently disconnected from a drain, an owner shall seal the opening to the pipe or drain in such a manner that the disconnection shall not be a danger to public health.

(2) Where a drain is permanently disconnected, an owner shall seal any remaining part of the drain.

(3) An owner shall notify the approving authority where a drainage installation is disconnected from a connecting trunk sewer within seven days from the date of the disconnection.

Control of objectionable discharge.

Disconnection of drainage installation.

249. An owner shall not—
- (a) interfere with a sewer or a connecting sewer situated outside the owner's premises; or
  - (b) interfere with any part of a drainage installation within the owner's construction site other than for the purpose of repair and maintenance.
250. (1) A drain, discharge pipe or ventilating pipe, shall be installed in such a manner that it withstands the test pressures required under paragraph 273.
- (2) A test to verify compliance with sub-paragraph (1), shall be carried out in the presence of an officer authorised by the approving authority.
- (3) Equipment, material or labour required for an inspection or testing contemplated in this Part shall be made available by the owner.
- (4) An owner shall not put into use a drainage installation before the installation has been inspected, tested and approved by the approving authority.
251. In a drainage installation, a joint type between pipes or between pipe and fitting shall—
- (a) be appropriate to the materials which the pipes and fittings are made;
  - (b) remain watertight under normal working conditions, or where there may be any differential movement between the pipes and a building, ground or other construction that form part of the drainage installation; and
  - (c) be able to withstand an internal water pressure of 50 kN/m<sup>2</sup> and an external water pressure of 30 kN/m<sup>2</sup> without leaking.
252. (1) A sanitary fixture shall be made of impermeable, non-corrosive material, have a smooth non-absorbent surface and be constructed and fitted so as to discharge through a trap, into a soil pipe or waste pipe, as the case may be.
- (2) The water supply outlet to a waste fixture shall be situated not less than 20mm above the flood-level rim of the fixture.
- (3) Sub-paragraph (2) shall not apply to a bidet.
253. (1) A water closet pan shall be designed and manufactured in accordance with the relevant requirements contained in—
- (a) KS 1106 (Specification for water closet (WC) plastic seats and covers);

Unauthorised works on drainage installation.

Inspection and testing of drainage installation.

Material, pipe, fitting and joint.

Sanitary fixture.

Water closet pan.

- (b) KS 1281 (Specification for water closet flushing cisterns); and
- (c) KS 1024-1 (Vitreous china water closet pans – Specification – Part 1: Vitreous china washdown water closet pans).

(2) A water closet pan which has a horizontal outlet spigot where the connection between the spigot and the soil pipe connected to it is made, by an adapter which can provide a slope downwards at a gradient of at least 1 in 40 towards the inlet of the soil pipe, shall be installed in a building.

(3) A water closet pan of the pedestal type shall be manufactured as a single unit and where the water closet pan is installed in a position so that the joint between its outlet spigot and the soil pipe into which it discharges, is concealed, the water closet pan shall be installed in a manner that there is access to the joint.

(4) A water closet pan of the wall-mounted type shall be manufactured as a single unit and shall be designed so as to enable the water closet pan to be firmly attached to a wall or be rigidly supported by a bracket.

(5) A water closet pan of the squat type may be manufactured in two parts, where the joint between the upper and lower parts is situated above the normal level of the water seal in the trap of the water closet pan.

(6) A water closet pan shall be served by its own separate flushing device.

(7) A seat associated with a water closet pan shall have a smooth non-absorbent surface and be held in place by fasteners made of corrosion resistant material.

(8) A flexible connector used to connect the outlet spigot of a water closet pan to a soil pipe shall—

- (a) not permit leakage of soil water at the joint;
- (b) have maximum water absorption of 2%;
- (c) be flexible to accommodate any dimensional variations and any surface irregularities of the spigot and pipe; and
- (d) be designed in accordance with—
  - (i) KS ISO 265-1 (Pipes and fittings of plastics materials, fittings for domestic and industrial waste pipes); and
  - (ii) KS ISO 4427-0 (Plastics piping systems for water supply and for drainage and sewerage under pressure – Polyethylene (PE)).

254. (1) A urinal shall be made of at least one slab, or a stall, trough, bowl or other suitable receptacle which shall have a smooth non-absorbent surface. Urinal.

(2) Where a slab or trough type urinal is provided, a 600mm length of the slab or trough shall be deemed to be equivalent to one urinal stall or bowl.

(3) A urinal or group of urinals shall have a flushing device.

(4) The requirement of sub-paragraph (3) may not apply with regard to a urinal that is specifically designed and constructed as a flush-less urinal.

(5) The urinal or group of urinals referred to in sub-paragraph (3) shall be so designed and installed that its entire surface, within its perimeter, from a distance of at least 100 mm below the outlet of its flushing device, is cleaned by the water discharged from the device.

(6) When a urinal is made of stainless steel, it shall be made as a single unit and shall be constructed in such a manner that—

- (a) a weld shall have a degree of corrosion resistance not less than that of stainless steel;
- (b) a crevice on the exposed side of joints shall be filled with weld metal; and
- (c) a removable cover shall be attached by means of a corrosion resistant fastener.

(7) The channel fitted to a slab or stall type urinal shall be graded with a fall of at least 1 in 100 and the outlet to this channel shall—

- (a) serve a slab urinal that does not exceed 4.8m, or eight stall units; and
- (b) have a trap, which shall have a corrosion resistant grating that is designed to retain solid matter without obstructing the flow of liquids.

(8) A grating shall not be installed in the case of a trap which serves a siphonic urinal.

(9) A joint between the parts of a urinal shall be corrosion resistant and watertight.

(10) A urinal of the wall-mounted type shall discharge by gravity and have the following minimum dimensions—

- (a) a vertical distance of 300 mm from the outlet of the bowl to the lowest point of discharge of flushing water into the urinal;
- (b) an external width of 300 mm at the widest point; and

- (c) a horizontal distance of 230 mm from the front of the lip to the wetted face immediately opposite the centre point of the lip.

(11) The urinal referred to in sub-paragraph (10) shall be manufactured as a single unit, and where it is a urinal flushed by wash-down action, it shall have a separate trap, or where it is flushed by siphonic, or jet action, it shall have an integral trap.

(12) A urinal having dimensions less than those contained in sub-paragraph (10) may be permitted if a trapped floor drain is installed in the same room.

(13) A flush-less urinal shall be constructed—

- (a) of inert material with a smooth finish and a high resistance to water absorption;
- (b) so that the inner surface of a bowl and outlet is smoothly curved to ensure that the flow of urine into a trap is unimpeded and cannot pond in the urinal; and
- (c) to have waste fittings and discharge piping made of plastic material or other material resistant to corrosion.

255. (1) A washing machine which is permanently connected to a drainage installation shall discharge through a trap into a waste pipe.

Electrical sanitary fixture.

(2) An owner shall not incorporate into a drainage installation, a mechanical food waste unit, disposal unit or garbage grinder, which has a power capacity that exceeds 500W unless the owner of the building has indicated on an approved plan that the working of the sewerage or sewage treatment system shall not be impaired by the installation of the mechanical food waste unit, disposal unit or garbage grinder.

(3) A food-waste disposal unit shall discharge through a trap having a depth of water seal of at least the relevant depth specified in this Code.

256. (1) In a room containing a sanitary fixture that is designated for use by females, means shall be provided for the disposal of sanitary towels.

Macerator type sanitary-towel disposer.

(2) A macerator type sanitary-towel disposer shall discharge through a trap into a soil pipe.

257. (1) Where a building is at a level in relation to the nearest connecting sewer that a drainage installation that serves the building cannot discharge into the connecting sewer by gravitation, the owner shall install an approved appliance, standby facilities, for purpose of raising sewage to a level that enables it to gravitate to the connecting sewer.

Sewage lift.

(2) The appliance referred to in sub-paragraph (1) shall be operated and maintained by the owner, and shall be designed and located so as not to be offensive, injurious or dangerous to health.

258. (1) A conservancy tank, septic tank and biodigester shall be designed by an engineer and shall—

Conservancy tank, septic tank, french drain and soak pit.

- (a) have a capacity in cubic metres;
- (b) be constructed with means of access for cleaning;
- (c) have a means for clearing.

(2) A conservancy tank, septic tank or biodigester, to be used on a construction site for the reception of sewage shall be—

- (a) designed and constructed in such a manner that it will be impervious to liquid;
- (b) sited—
  - (i) at a distance of between 4m and 10m from the building which is served by the conservancy tank, septic tank or biodigester;
  - (ii) in such a manner that there will be a ready means for the clearing of the tank;
  - (iii) so as not to endanger the structure of a building or service on the construction site or neighbouring parcel of land; and
  - (iv) within the boundary; and
- (c) designed and sited in such a manner that the conservancy tank, septic tank or biodigester is not likely to become a nuisance or danger to health.

(3) A septic tank or biodigester, shall discharge, subject sub-paragraph (8), discharge into an appropriate and properly designed soakage.

(4) A septic tank shall not be installed in such a manner that the wall of the tank is the same as a wall of the building the tank serves; or installed under the building the tank serves.

(5) A conservancy tank shall—

- (a) where it is to serve a dwelling house or dwelling unit, have a capacity of at least 1.7m<sup>3</sup>;
- (b) have a capacity containing three days' sewage flow as specified in Table 39 set out in the First Schedule;
- (c) where it is to serve a building that is not a dwelling house or dwelling unit, have a capacity of at least three times the daily flow from the building, using the per capita sewage flow specified in Table 40 set out in the First Schedule or such other flow as may be determined by an engineer where it is not specified in Table 40;
- (d) be so constructed that—
  - (i) it is provided with a means for cleaning; and



- (ii) the depth in the tank below the outlet invert is at least 1m and there is an airspace of at least 200mm between the surface of the liquid contained therein and the underside of the top cover of the tank.

(6) The sewage flow to a septic tank or biodigester, shall be in accordance with the flow specified in Table 40 set out in the First Schedule.

(7) Industrial effluent shall not be allowed to flow into a septic tank.

(8) A french drain which is to receive effluent or an evapo-transpirative bed shall—

- (a) be designed to have a slope of at least 1% from the centre junction box and deep enough to allow at least 100mm of topsoil placed on top of the geo textile fabric wrap to support sod; and
- (b) in relation to the construction site in which it is proposed to be constructed, be tested for percolation in accordance with the method in Table 34 set out in the First Schedule.

(9) Where, after testing in accordance with sub-paragraph (8) (b), the construction site has been found suitable for the use of a french drain, the french drain shall be so constructed that the rate of application of effluent to the infiltration area, and the percolation rate within the french drain, does not exceed that in Table 41 set out in the First Schedule.

(10) A french drain shall not be constructed on a construction site where—

- (a) the ground has a percolation rate that exceeds thirty minutes;
- (b) effluent may flow out due to the contours of or the strata that form the ground;
- (c) the construction site to be affected by the effluent, is of an insufficient size to accommodate the soaking away of the effluent;
- (d) the level of the water table may prevent adequate percolation; or
- (e) the construction site may be affected by the presence of the french drain.

(11) A biodigester shall be designed and located in such a manner that—

- (a) where the annual average temperature is above 180C, the hydraulic retention time is at least fifteen days;
- (b) where the annual average temperature is below 180C, the hydraulic retention time is at least twenty-five days;

(c) allows for regular desludging to maintain a steady level of effluent in the system; and

(d) there is access for desludging.

(12) An evapo-transpirative bed may be installed instead of a french drain.

259. (1) A building used as a stable, garage, cowshed, dairy, kennel, butchery, abattoir, a vehicle washing space, or other similar space that requires regular cleaning, which produces waste water or soil water shall be connected to a drain which shall serve the building or space.

Discharge from washing space.

(2) The space referred to in sub-paragraph (1) shall be—

(a) paved with approved impervious material;

(b) graded to a gully which shall be fitted with a removable grating;

(c) connected to at least two approved silt traps, grease traps, petrol or oil interceptors;

(d) roofed over; and

(e) surrounded by a kerb that is at least 100mm high, or elevated above the immediately surrounding ground level by at least 100mm.

260. (1) Where a swimming pool, fountain or reservoir, is required by the owner to have an overflow to lead away excess rainwater, the overflow shall be designed and constructed to discharge—

Discharge from swimming pool, fountain or reservoir.

(a) onto the construction site on which the pool, fountain or reservoir is situated; or

(b) into an approved surface channel, storm-water drain or natural watercourse.

(2) A swimming pool, fountain or reservoir, shall be designed and constructed in such a manner that the water from the backwashing of a filter is discharged onto the construction site on which the swimming pool, fountain or reservoir is situated, or into a drain.

261. (1) The number of sanitary fixtures to be provided in a building shall be based on the occupancy for which the building is designed.

Provision of sanitary fixture.

(2) The number of sanitary fixture units referred to in sub-paragraph (1)—

(a) where in an occupancy, separate sanitary facilities shall be provided for each sex, based on the occupancy of that particular sex for which the facilities are intended, and if the number of persons of each sex cannot be

determined, shall be assumed to be in equal proportions;

- (b) where the fixtures are to be situated in separate groups, in relation to a group, shall be based on the calculation of that portion of the total occupancy for which the group is intended;
- (c) in relation to a building for which the occupancy cannot be determined and where the building contains at least one habitable room, shall be at least one water closet pan and one wash hand basin; and
- (d) for every five units provided for able-bodied persons, shall be one unit provided for persons living with a disability.

(3) The minimum number of sanitary fittings to be provided in a building shall be as specified in Table 34, Table 35, Table 36, Table 37, Table 38 and Table 23 set out in the First Schedule, and the fixtures shall—

- (a) be situated in places which are convenient to access; and
- (b) where necessary, be designated for use by males, or females, or both.

(4) A room containing sanitary fixtures shall lockable from inside.

(5) The occupancy referred to in column 1 of Table 34, Table 35, Table 36, Table 37, Table 38 and Table 23 set out in the First Schedule, is the occupancy of the particular sex for which the minimum provision is to be determined, unless the occupancy of each sex is otherwise known, this will be half of the total number of persons or total occupancy.

262. (1) A hydraulic load discharged into or carried by a discharge pipe or drain shall be calculated in sanitary fixture units.

Hydraulic loading of drainage installation.

(2) The hydraulic load at a point in a discharge pipe or any drain, shall be the sum of the sanitary fixture unit ratings of all sanitary fixtures the discharges from which, enter the discharge pipe or drain upstream of the point.

(3) The hydraulic load discharged from a sanitary fixture in column 1 of Table 42 set out in the First Schedule, shall be as specified in column 3 thereof, and where a sanitary fixture is not listed in column 1, the diameter of the trap outlet of the fixture, where identified in column 2, shall indicate the hydraulic load, in column 3, which is to be applied for the fixture.

263. (1) The following requirements shall apply with regard to a single stack system—

Drainage system.

- 
- (a) it shall only be installed where the building is a non-residential building which has sanitary fixtures installed in ranges, or is a residential building which has sanitary fixtures installed in groups;
  - (b) it shall not be installed in a residential building that exceeds thirty storeys in height, or in a non-residential building that exceeds twenty-four storeys in height, above the lowest ground level abutting the building;
  - (c) a trap vent for the protection of a water seal shall not be required in terms of this sub-paragraph or in terms of sub-paragraphs (2) or (3);
  - (d) a supplementary vent stack referred to in sub-paragraph (2) or (3) shall be cross-connected at each storey with the discharge stack above the level of the highest branch discharge pipe connection to the discharge stack;
  - (e) the discharge stack shall be continued upwards to form a stack vent;
  - (f) the radius of the centre line of a bend at the foot of the discharge stack shall be at least 300mm;
  - (g) an offset shall not be made in a discharge stack unless a ventilating pipe is provided to reduce pressure which may be caused by an offset, and the nominal diameter of the ventilating pipe shall be at least half the diameter of the discharge stack;
  - (h) every waste fixture trap shall be a 'P' trap which has a water seal of at least 75 mm in depth, or a resealing trap of the 'P' type;
  - (i) the vertical distance between the invert of the lowest branch discharge pipe connected to a discharge stack and the invert of the bend at the foot of the stack shall be at least—
    - (i) 450 mm for a stub stack where a stack in a single dwelling that does not exceed three storeys in height, and stacks of up to two storeys in height serving a maximum of two groups of sanitary fixtures; and
    - (ii) 750 mm for stacks of up to five storeys in height in other buildings; and one storey in height for stacks that exceed five storeys;
  - (j) where a waste branch and an opposed soil branch from a water closet pan is connected to a discharge stack the centre line of the waste branch shall not intersect the centre line of the stack within 200 mm below the intersection of the centre line of the soil branch with the centre line of the stack; and

- (k) the inlet of a branch discharge pipe or a fixture discharge pipe joining a discharge stack of equal diameter shall be swept in the direction of flow with a radius of not less than 50mm or shall be at an angle of 45 degrees.
- (2) The following additional requirements shall apply with regard to a single stack installation in a residential building—
- (a) the fixture branch of a sanitary fixture in a sanitary group shall be separately connected to the discharge stack;
  - (b) where the trap fitted to a hand wash basin has a nominal diameter of 32mm, the internal diameter of the fixture branch serving the wash hand basin shall be at least 40 mm;
  - (c) not more than two sanitary groups installed in a one storey shall be connected to the same discharge stack;
  - (d) a discharge stack not exceeding two storeys in height serving a maximum of two groups of sanitary fixtures may discharge into a stub stack; and
  - (e) the minimum discharge stack size and, where required, supplementary vent stack size and cross-ventilation requirements shall be as specified in Table 43 set out in the First Schedule.
- (3) The following additional requirements shall apply with regard to a single stack installation in any non-residential building—
- (a) where sanitary fixtures are installed in ranges as specified in column 2 of Table 44 set out in the First Schedule, the minimum nominal diameter of a discharge stack and of a supplementary vent stack, where required, shall be as specified in columns 3 and 4 respectively, for the number of storeys served by the discharge stack specified in column 1;
  - (b) a soil or waste branch discharge pipe to which the sanitary fixture is connected, shall be separately connected to the discharge stack;
  - (c) for the purposes of Table 44, a number of urinals that does not exceed four may be regarded as equal to one water closet pan; and
  - (d) where a closed system is used and a branch discharge pipe is connected to a stub stack, the closed system shall not receive the discharge from more than four sanitary fixtures in a range.
- (4) The following requirements shall apply with regard to a one-pipe system—

- (a) a soil pipe shall be connected to another soil pipe, a stack or directly to a drain;
  - (b) a waste pipe shall be connected to another waste pipe, a soil pipe, a stack, directly to a drain or to a gully which shall be connected to a drain; and
  - (c) any waste or any soil fixture trap may have a common ventilating pipe.
- (5) The following requirements shall apply with regard to a two-pipe system—
- (a) a soil pipe shall be connected to another soil pipe, a stack or directly to a drain;
  - (b) a waste pipe shall discharge into another waste pipe, a stack or to a gully which shall be connected to a drain; and
  - (c) a waste and soil fixture trap shall be separately ventilated.
264. (1) In determining the size of a discharge pipe—
- (a) the nominal diameter of a discharge pipe shall not be less than the internal diameter of a pipe or outlet of a sanitary fixture which discharges into it;
  - (b) where the nominal diameter of a horizontal pipe in an offset is more than that of the discharge stack which discharges into it, the nominal diameter of the stack downstream of the off-set may be less than that of the horizontal pipe;
  - (c) the internal diameter of a soil pipe, other than a soil pipe from a urinal, shall be at least 100mm;
  - (d) the internal diameter of a waste pipe shall be at least 32mm if it serves a hand wash basin, bidet or drinking fountain, and at least 40mm if the pipe serves any other waste fixture;
  - (e) in a single stack system, the internal diameter of a waste pipe shall be at least 40mm; and
  - (f) the hydraulic load carried by a discharge pipe which has a nominal diameter specified in column 1 of Table 24 set out in the First Schedule, shall not exceed the number of fixture units specified in columns 2, 3 or 4, as the case may be.
- (2) Where a horizontal pipe to which a discharge stack is connected, is larger than the stack, a bend connecting the horizontal pipe to the stack shall have a nominal diameter equal to that of the horizontal pipe.
- (3) A waste pipe which has a diameter of at least 100mm and a soil pipe shall, subject to sub-paragraph (4), be deemed to

Sizing of  
discharge pipe.

be a drain from that point downstream of which the gradient of the pipe, or of a drain, to which it is connected does not again exceed 45° below the horizontal, except where the pipe or drain is connected to a connecting sewer.

(4) Where the diameter of a horizontal pipe at the base of a discharge stack is more than that of the drain to which it discharges, the horizontal pipe shall have a length of at least 2.5m, measured from the centre line of the discharge stack, before it is reduced in diameter and connected to the drain.

265. The following requirements shall apply with regard to the sizing of a drain— Sizing of drain.

- (a) the nominal diameter of a drain shall be at least 100mm;
- (b) the hydraulic load carried by a drain which has a nominal diameter specified in column 1 of Table 39 set out in the First Schedule and a gradient specified in columns 2 to 14, as the case may be, shall not exceed the number of sanitary fixture units given in the table for the diameter and gradient of drain;
- (c) where due to slope of the ground a drain is required to be laid at a gradient steeper than 1 in 5, the hydraulic load carried by the drain shall not exceed that in column 2 of Table 39 set out in the First Schedule, for a gradient of 1 in 5; and
- (d) where the depth of an open drain exceeds 600mm the side soil shall be supported by an impervious side slab sloped to a gradient of 1 in 3 or as designed by an engineer.

266. (1) In preserving a water seal under working conditions, the water seal contained in the trap of a soil fixture shall be protected by a trap vent where the discharge from the soil fixture is conveyed by— Protection of a water seal.

- (a) an unventilated branch drain or soil pipe which has a fall exceeding 1.2m within 300mm of the outlet of the fixture trap;
- (b) an unventilated soil pipe which receives the discharge from any other soil fixture;
- (c) a discharge stack which receives at higher level the discharge from any other soil fixture; or
- (d) a soil branch which receives the discharge from any other soil fixture.

(2) The trap vent referred to in sub-paragraph (1) may be omitted where a soil fixture discharges to a soil branch where—

- (a) the hydraulic load carried by the soil branch does not exceed 50 fixture units;
  - (b) the soil branch is served by a 100mm diameter back vent; and
  - (c) not more than sixteen soil branches discharge into the same discharge stack.
- (3) Without prejudice to the requirements of sub-paragraph (1)—
- (a) in the case of an installation of the two-pipe system, the water seal in the trap of a waste fixture shall be protected by a trap vent, unless a resealing trap is fitted to the fixture; and
  - (b) in the case of an installation of the one-pipe system, the water seal in the trap of any waste fixture shall, except in the case of the single stack system, be protected by a trap vent.
- (4) The requirement of sub-paragraph (3)(a) shall not apply to a single bath, shower or sink, which discharges independently into a gully where the bath, shower or sink is situated within 2m vertically above and 3m horizontally from the gully.
- (5) The water seal in the trap of a waste fixture which is required to be protected in accordance with sub-paragraph (3) may, as an alternative, be protected by a vent valve.
- (6) A ventilating pipe shall be provided for a—
- (a) main drain or branch drain, at a point that does not exceed 6m from the head of the main drain or branch drain, as the case may be, where the head is deemed to be the centre-line of the discharge stack or vertical discharge pipe to which the main drain, or branch drain, is connected, except where—
    - (i) for a branch drain, where the length measured along the branch drain from its head to the point of connection to any ventilated main drain, does not exceed 6m; or
    - (ii) where a main drain or branch drain is connected to a discharge stack having a stack vent;
  - (b) soil branch which receives the discharge from only one sanitary fixture and which exceeds 6m in length, measured along the branch from the outlet of the trap of the fixture to the point of connection, to a ventilated soil pipe;
  - (c) waste pipe longer than 6m, measured along the pipe from the outlet of the trap of a waste fixture discharging to it, to the point of discharge of the pipe into a gully, or in the case of the one-pipe system, to



the point of connection of the waste pipe with a ventilated soil pipe or a ventilated drain:

Provided that the vent pipe may be omitted where the diameter of the waste pipe, as specified in column 1 of Table 45 set out in the First Schedule, is increased by one nominal pipe size and the length of the waste pipe is does not exceed 10m;

- (d) waste branch longer than 6m, measured along the branch from the outlet of the trap of a waste fixture discharging into it, to its point of connection to a ventilated waste pipe;
- (e) stub stack where—
  - (i) the crown of a water closet trap connected to the stack exceeds 1.5m above the invert of the bend at the base of the stack;
  - (ii) the topmost connection of a waste pipe to the stack exceeds 2m above the invert of the bend at the base of the stack;
  - (iii) the stack serves more than one group of sanitary fixtures; or
  - (iv) the stack serves branch discharge pipes to which ranges of sanitary fixtures are connected.

267. The following requirements shall apply with regard to the sizing of a ventilating pipe—

Sizing of ventilating pipe.

- (a) a drain, branch drain or a part of a drain carrying a hydraulic load that exceeds 50 fixture units, shall have a ventilating pipe with a nominal diameter of at least 40mm;
- (b) the diameter of a ventilating pipe shall be at least that specified in Table 45 set out in the First Schedule for the relevant developed length of the pipe, and the sum of the fixture units derived from a sanitary fixture whose traps are ventilated, either directly or indirectly, by the ventilating pipe;
- (c) a stack vent shall have a nominal diameter which is not less than that of the discharge stack to which it is connected:

Provided that a stack vent connected to the following types of discharge stack may have a nominal diameter less than that of the discharge stack but shall have a nominal diameter of at least 40mm—

- (i) a stub stack, where a stack vent is required; and
- (ii) a discharge stack of two storey height serving a maximum of two groups of sanitary fixtures;

- (d) where a stack vent is connected to the top of a discharge stack, the connection shall be at a point that is at least 150mm above the flood level of the highest positioned sanitary fixture in the drainage installation which discharges to the discharge stack:

Provided that the nominal diameter of the stack vent connected to the discharge stack shall not be less than the nominal diameter of the discharge stack or not less than that required under this paragraph;

- (e) the developed length of a branch vent shall be measured from the point of its connection to a vent stack, or stack vent, to the farthest trap vent connected to the branch vent;
- (f) the developed length of a back vent shall be measured from the point of its connection to a vent stack, or stack vent, to the furthest point of its connection to a discharge pipe; and
- (g) the developed length of a vent stack shall be measured from the open end of the vent stack or, where the vent stack is connected to a stack vent, from the open end of the stack vent to the farthest trap vent served by it, or its furthest point of connection to a discharge pipe, whichever is longer.

268. (1) A discharge pipe or ventilating pipe shall—

Installation of discharge pipe or ventilating pipe.

- (a) not cause electrolytic corrosion due to an association of dissimilar metals;
- (b) not be deformed in a way that would restrict flow;
- (c) be installed in such a manner as to ensure that a bend does not form an acute angle and has the largest practicable radius of curvature with no change in the cross section of the pipe throughout the bend;
- (d) be safely supported at intervals along its length without restraining thermal movement;
- (e) be installed such that the gradients, where applicable, are within the limits in Table 46 set out in the First Schedule;
- (f) be so installed as to withstand the test specified in paragraph 273; and
- (g) have a means of access for internal cleaning.

(2) Where a discharge pipe is located within a building and it is desired that the pipe be enclosed, it shall be enclosed within a duct.

(3) Despite sub-paragraph (2), a part of a pipe may be built into brickwork or concrete, where the interior of the part is rendered readily accessible for cleaning.

(4) The duct referred to in sub-paragraph (2) shall be easily accessible or have covers that can be readily removed to enable access to be gained to all junctions, bends and cleaning eyes.

(5) Where a duct is installed, there shall be provided inside the duct a means which in the event of any leak from any pipe therein will direct any released liquid or matter from the area of the room to a point of discharge where it shall be readily detectable.

(6) A pipe shall be installed in such a manner that the removal of a part of a building for the purpose of gaining access to the pipe shall not endanger the structural stability of the building.

(7) A discharge pipe or a ventilating pipe shall withstand external damage.

(8) A ventilating pipe shall be—

- (a) carried upwards without a reduction in diameter, and shall throughout its length, be horizontal or so graded as to provide a continuous fall from its open end back to the discharge pipe, or drain to which it is connected; and
- (b) installed in such a manner that the open end of the ventilating pipe is at least—
  - (i) 2.5m above finished ground level;
  - (ii) 100mm above the closest part of the roof covering of the building through which it passes, or to which it is attached;
  - (iii) 2m above the head of a window, door or other opening in the same building, or any other building, whether or not on the same construction site, within a horizontal distance of 5m of the said open end; and
  - (iv) 2.5m above the surface level of a roof slab covering the building which it serves, where the slab may be occupied by people.

(9) A trap vent shall be connected to the crown of the fixture discharge pipe on the outlet side of the protected trap at a point that is between 75mm and 750mm from the crown of the trap, and the trap vent shall, unless carried up independently, be connected to another ventilating pipe at a point that is at least 150mm above the flood-level of the sanitary fixture which the trap vent serves.

(10) Where a two-pipe system is installed, a ventilating pipe serving a soil pipe, or a soil fixture shall not be connected to a ventilating pipe serving a waste pipe or a waste fixture.

(11) Where a supplementary vent stack is installed in addition to, and adjacent to, a discharge stack, the vent stack shall be connected to the discharge stack at a point below the lowest branch discharge pipe connection to the discharge stack and continued upwards, either independently or interconnected with the discharge stack.

(12) The interconnection between a ventilating pipe and a discharge pipe or drain, shall be located and made such that no soil water or waste water can be discharged through a ventilating pipe.

269. (1) A drainage installation shall be designed and constructed in a manner that permits access to the interior of a pipe in the installation, for the purposes of inspection, testing and internal cleaning.

Access to  
drainage  
installation.

(2) Where a discharge pipe enters the ground, means of access to the interior of the pipe shall be 2m above the point of the entry.

(3) Where a drain or discharge pipe passes through a room which is used as a kitchen, pantry or for the preparation, handling, storage or sale of food, the means of access to the drain or pipe, for cleaning purposes, shall be situated outside the room.

(4) The requirement of sub-paragraph (3) shall not apply where the waste pipe serving a waste fixture is contained in the room.

(5) An access opening to a drain or discharge pipe installed within a building shall be covered by a screwed or bolted airtight cover.

270. (1) A rodding eye shall be installed where there is a change in the direction of the drain that exceeds 45° and at a point within 1.5m of the connection of the drain to a connecting sewer, septic tank, conservancy tank or biodigester.

Rodding eye.

(2) Where a bend which has a centre line radius of at least 600mm is installed, the rodding eye may be omitted for not more than two of the changes referred to in sub-paragraph (1) of up to 90°, each between any two rodding eyes, is required.

(3) Despite sub-paragraph (7), a rodding eye shall be installed immediately downstream of the point—

- (a) at the highest point of the drain; and
- (b) at the intervals along the drain that no rodding distance exceeds 25m measured along the line of the drain from a rodding eye or other permanent means of access to the drain and the rodding eye shall—

- (i) join the drain in the direction of flow at an angle that does not exceed 45°;
- (ii) be continued up to ground level;
- (iii) be adequately supported; and
- (iv) be adequately marked and protected.

(4) The access contemplated in this paragraph may, subject to additional requirements set out in this Code, be provided by the installation of an inspection chamber or manhole.

(5) Permanent access, contemplated in this paragraph, which is covered by any paved area of ground, shall be covered by a marked removable device.

(6) Where a part of a drainage installation passes under a building there shall be—

- (a) access provided to the installation outside of, and as near as possible to, the building at each point of entry or exit from under the building; and
- (b) no access provided from within the building.

(7) The lid covering an opening which gives access into a drainage installation shall be sealed in such a manner that the lid will remain effective under any working conditions.

(8) Means, other than a manhole or inspection chamber, provided for access to a drainage installation shall—

- (a) have a removable cover and be designed and constructed in a manner that will sustain a normal load which may be imposed on it and exclude the ingress or egress of water;
- (b) permit access to the installation for the purposes of inspecting, testing or cleaning, as the case may be; and
- (c) when within a building, be constructed in such a manner as to be watertight when subjected to a maximum internal water pressure of 50 kPa.

(9) A manhole or inspection chamber shall be—

- (a) located in an open-air space;
- (b) constructed and covered in a manner that prevents the ingress of water; and
- (c) of sufficient strength to sustain a load which may normally be imposed on it.

(10) An inspection chamber shall have a minimum plan dimension of at least 450mm.

(11) The requirement specified in sub-paragraph (9)(a) shall not preclude a location under the roof of a garage or a similar well-ventilated area outside the building.

(12) Where the connection between two sections of a drain is at different levels, which necessitates a steep fall, the change in level shall be affected by at least one 22.5° bend which shall be connected to the shortest possible length of drain pipe connected in turn through at least one 22.5° bend to the lower drain.

271.(1) A sanitary fixture shall be provided integrally or immediately at its outlet with a self-cleaning trap, except where the fixture is a bath, wash hand basin or shower, which discharges into—

Provision of trap.

- (a) an open channel which shall—
  - (i) be made of impervious material;
  - (ii) have a semi-circular cross-section of a diameter of at least 100mm;
  - (iii) be accessible for cleaning throughout its length;
  - (iv) be fixed immediately beneath the point of discharge; and
  - (v) discharge into a gully; or
- (b) an open channel serving a urinal where the bath, wash hand basin or shower, is installed in the same room as the urinal.

(2) A trap which is integral with a sanitary fixture shall—

- (a) have a smooth waterway; and
- (b) be so constructed that a change from one cross-section to another does not cause an obstruction to the passage of solids.

(3) A trap that is not integral with a sanitary fixture shall be made of non-absorbent and corrosion resistant material and shall be constructed in a manner that—

- (a) it has a smooth waterway;
- (b) there is no constriction;
- (c) it has an outlet diameter which is not less than that of its inlet; and
- (d) it has, at its lowest point, a means of access for cleaning, unless the trap is made of rubber or other similar material.

(4) The minimum nominal diameter of a trap connected to a sanitary fixture, and the minimum depth of its water seal, shall be in accordance with the dimensions for the relevant fixture and installation in Table 47 set out in the First Schedule, except that the maximum depth of the water seal contained in a trap shall be 100mm.

(5) Where a trap serving a water closet pan is provided with a vent stack, the horn shall have a nominal diameter of at least 40mm and shall be located at the side of and at least 75mm from the crown of the trap on its outlet side.

272. (1) A drainage installation shall have one gully, where— Provision of gully.
- (a) the head of the gully shall consist of—
    - (i) an overflow fitting covered with a removable cover which fits over the gully head and permits overflow through a cross-sectional area that is not less than that of the trap of the gully, but that prevents the ingress of foreign matter directly from above; or
    - (ii) a hopper covered with a removable grating set in the gully head and the spaces between the bars of the grating shall be between 10mm and 12mm wide and shall provide an open area through the bars of not less than the minimum cross-sectional area of the trap of the gully; and
  - (b) a gully head which may be dished, in which case the overflow level of the dish shall be at least 75mm above the level of the grating of the gully.
- (2) An overflow level of a gully shall be at least—
- (a) 150mm below the crown of the lowest trap serving a sanitary fixture in the installation, unless it is a sanitary fixture where its discharge is raised; and
  - (b) 150mm above the surrounding ground or 50mm above a permanent surrounding paving and the paving shall ensure drainage away from the gully.
- (3) A gully trap shall—
- (a) have a nominal diameter equivalent to its minimum cross-sectional area and the depth of its water seal shall be in accordance with sub-paragraph (1);
  - (b) the surface level of the water in the gully shall not exceed 500mm below the overflow level of the gully where the gully is a dished gully; and
  - (c) the water seal in a gully shall be maintained by means of at least one waste pipe which discharges into the gully.
- (4) A provision for installation of one gully shall not be deemed to preclude more gullies being fitted, should they be required.
- (5) A trapped floor drain may be installed within a building as a waste water outlet in a floor which shall slope at a gradient of at least 1 in 200 from all sides towards the floor drain.
- (6) The floor drain referred to in sub-paragraph (5) shall—
- (a) be located to make it accessible;
  - (b) be made of non-absorbent and corrosion resistant material;
  - (c) have a minimum outlet diameter and the trap seal depth outlined in paragraph 270(4);

- (d) have a removable grating, the open area of which shall be not less than two-thirds of the area of the waste pipe into which the outlet discharges; and
  - (e) have its water seal maintained by means of—
    - (i) a tap situated above it; or
    - (ii) a waste fixture located in the same room, the outlet of which will discharge waste water directly into the gully above the level of the water seal in a manner that prevents overflow onto the floor.
- (7) A suitable grease trap shall be provided to take the discharge of waste water from a sink or another fixture—
- (a) in a building where waste water is to be discharged to a french drain; and
  - (b) where the discharge of grease, oil or fat may cause an obstruction to the flow in a drain or sewer or may interfere with the efficient operation of a sewage disposal system.
- (8) A grease trap shall be designed and constructed to have a removable lid or a manhole cover which shall permit the effective removal of grease, oil, fat or solid matter.
- (9) A paved area on which petrol, oil, or wash-water contaminated with petrol or oil, may fall shall be graded and drained to a gully which shall discharge into a suitable petrol or oil interceptor trap, which shall discharge into a drain.
- (10) The surface level of the water in a gully trap shall be not exceed 500mm below the top of a dished gully.
- (11) Where it is impracticable to level a gully in accordance with sub-paragraph (10)—
- (a) the gully trap shall be located in a manhole which shall have walls up to a height of at least 150mm above the surrounding ground; and
  - (b) the access to the manhole shall be covered with a metal grating of a strength that can sustain a load which may normally be imposed on it.
- (12) A waste pipe which discharges into a gully shall discharge at a point above the surface of the water seal of the gully trap but not exceeding 100mm above the level of the grating.
- (13) A gully shall be situated outside a building, or in any place which is permanently open to external air, and shall be accessible for cleaning and maintenance:

Provided that a gully may be installed within a building as a waste water outlet in a floor, and be located such that it is easily accessible, and the floor shall slope at a gradient of at least 1 in 200 from all sides towards the gully.



(14) The outlet contemplated in sub-paragraph (13) shall be made of non-absorbent and corrosion resistant material, and shall have a diameter of at least 50mm.

273. (1) Where a drain is constructed adjacent to, under or through a structural part of a building, measures shall be taken to ensure that the trench in which the drain is laid does not impair the stability of the building, or the stability of any other building, or interfere with, or affects an existing service.

Installation of  
drain.

(2) Where a portion of a drain passes under a building, the portion shall—

- (a) be protected against the transmission of a load to it;
- (b) be laid without change of direction or gradient; and
- (c) not have a means of access for cleaning from inside the building.

(3) Where a portion of a drain passes through a building the portion shall be—

- (a) supported throughout its length without restricting thermal movement and the support shall be attached to the building; and
- (b) placed such that at a junction, bend or point of access into it, is accessible.

(4) A drain shall be laid—

- (a) in a straight line between points where changes of direction or gradient occur;
- (b) with approved flexible joints which—
  - (i) permit joint movement to take place throughout the life of the drainage installation;
  - (ii) withstand root penetration and do not deteriorate when in contact with sewage or water; and
  - (iii) does not cause any obstruction in the interior of the drain;

(c) at a gradient, suitable for the hydraulic load to be carried by the drain, as specified in Table 39 set out in the First Schedule; and

(d) with anchor blocks to securely fix in a place where its gradient may exceed 1 in 5.

(5) Every drain shall have—

- (a) soil cover over the outside of the drain of at least 300mm; or
- (b) precast or cast-in-situ concrete slabs placed over the drain, isolated from the crown of the pipe by a soil cushion of at least 100mm in thickness and the slabs shall be wide enough and strong enough to prevent excessive superimposed loads being transferred directly to the pipes.

(6) Where a drain has a branch drain connected to it, the connection shall—

- (a) be by means of a junction fitting which shall not be a saddle junction; and
- (b) enable the flow from the branch drain to enter the drain obliquely in the direction of flow so that the included angle between the axes of the 2 drains does not exceed 45°.

(7) A drainage installation on at least two construction sites, whether the construction sites have the same owner or otherwise, may be permitted to discharge into a connecting sewer through a common drain.

274. (1) After a drainage installation has been completed and partially back-filled, the drain shall—

- (a) be tested with an air test conducted by pumping air into the drain under a pressure of at least 0.35 kPa (35 mm head of water); and
- (b) be deemed to have passed the test if the pressure after three minutes is at least 0.25 kPa (25 mm head of water).

Test for discharge pipe or ventilating pipe.

(2) A discharge pipe or ventilating pipe shall be tested as follows, after a drainage installation has been completed—

- (a) all traps shall be filled with water;
- (b) the outlets of all ventilating pipes shall be plugged; and
- (c) the air test specified in sub-paragraph (1) shall be applied.

275. (1) For the purpose of establishing the suitability of the soil in which a french drain is to be constructed, the following test procedure and evaluation shall be carried out—

In-situ percolation test for soil.

- (a) a test hole or, where necessary, a number of holes uniformly spaced shall be excavated on the construction site to a depth estimated for the proposed french drain;
- (b) the bottom 350mm of the hole shall have a diameter of 300 mm or have a plan shape 300 mm square;
- (c) the sides of the bottom part shall be roughened to provide a natural infiltration surface;
- (d) loose material shall be removed from the bottom of the hole and shall be replaced with a 50 mm thick layer of gravel to prevent scouring when the hole is filled with water;
- (e) the hole or holes shall be filled with water to a height of at least 300mm above the gravel and maintained at that level for a period of at least four hours;
- (f) at the end of the period in sub-paragraph (1) (a), the level of the water in the hole or holes shall be marked and the time noted and drop in level of the water as it soaks away over a subsequent period of thirty minutes shall be measured;

- (g) where all the water percolates away before thirty minutes, the actual time taken for this to occur shall be measured;
- (h) the percolation rate shall be reported as the time taken for the water level to drop 25mm; and
- (i) where a number of holes are tested, the average percolation rate for the construction site shall be calculated and the average shall be used as the percolation rate for the french drain effluent.

(2) Where the percolation rate determined pursuant to sub-paragraph (1) is less than thirty minutes, the soil on the construction site shall be suitable for the construction and use of a french drain.

276. (1) An owner shall construct or install means for the control and disposal of storm-water which may run off from the construction works.

Storm-water disposal.

(2) The means of storm-water disposal referred to in sub-paragraph (1) may be in addition to or in combination with other drainage works required under this Code.

(3) Sub-paragraph (1) shall be satisfied where the means of storm-water disposal is the subject of a design prepared by, or under the supervision of an architect and an engineer, or means of storm-water disposal provided under this Part.

(4) Means of storm-water disposal referred to in sub-paragraph (1) shall include—

- (a) where there is a building on the construction site, a roof valley, gutter, down pipes or, other means of ensuring that storm-water from a roof is controlled and will flow away from the building; and
- (b) a surface storm-water drain, channel or below-ground storm-water drain, that may be necessary to convey storm-water away from the construction site or from one part to another part of the construction site.

277. (1) A valley or gutter shall have a cross-sectional area of at least 115mm<sup>2</sup> in cross sectional area of the valley or, gutter, per 1m<sup>2</sup> of the roof plan area served.

Valley, gutter or downpipe.

(2) The requirements in respect of a downpipe shall be satisfied where the internal cross-sectional area of the downpipe is not less than 100mm<sup>2</sup> per 1m<sup>2</sup> of roof plan area served by the downpipe, provided that the internal cross-sectional area is at least 4,400mm<sup>2</sup>.

278. On a storm-water drain, means of access shall be installed at intervals such that no part of the drain, measured along the line of the drain, exceeds 40m from the means of access.

Access to storm-water drain.

279. Where a storm-water sewer is available in a road abutting a construction site to have storm-water drainage, the owner of the construction site shall at their own cost, install at least one storm-water drain to be connected by the approving authority to the storm water sewer.

Connection to storm-water sewer.

280. (1) Where the capacity of a road surface drainage system is considered adequate to accept the discharge of storm-water from a construction site, storm-water may be discharged into the road surface drainage system.

Surface drainage system on road.

(2) The owner of the construction site referred to in subparagraph (1) shall provide at least one conduit to convey the storm-water to the road surface drainage system.

281. (1) The lowest storey of a building shall be at the level, or so constructed in a manner that allows the construction of a drain for the effectual drainage of that storey.

Drainage of storeyed building.

(2) Sub-paragraph (1) may not apply where a storey comprises of a basement or another chamber below ground level that is intended for storage only and constructed to be impervious to water.

282. (1) The roof of a building shall be so constructed, or provided with appliances for drainage, as to prevent rain which may fall upon it, from causing dampness in any part of the building, including the interior, or damage to the foundation.

Drainage of roof.

(2) A building shall not be designed in such a manner that rain water from it would be discharged over or upon a road.

(3) A rain water pipe at a height of below 3m above pavement level, shall not project beyond the building line.

(4) A building shall have a provision for rain water harvesting.

283. (1) An owner shall not cause or permit subsoil, surface, storm or rain water or a drain for the conveyance of the waters thereof to discharge into, or communicate with, a sewer for the conveyance of sewage or waste water except on the condition that the subsoil, surface, storm or rain water drain, shall discharge directly into the open air or into a gully trap the level the water in the sewer, or otherwise be disconnected.

Surface water.

(2) A person shall not discharge storm or rain water, in to a neighbouring parcel of land.

(3) A person shall not cause or permit, a sewage or waste water drain to discharge into, or communicate with, a storm water drainage system.

(4) Surface water from a construction site shall be disposed of in an approved manner.

(5) A paved area laid to a fall, a gully or a channel shall be connected to the approved point of disposal.

284. If at least two buildings may be drained advantageously in combination, and a sewer of sufficient size already exists, or is about to be constructed within 70m of the buildings, when the drains of the buildings are first laid, the building may be drained by a combined system of drainage.

Combined system of drainage.

285. A person who carries out works related to a drainage installation on a road shall—

Drain in road.

- (a) not disturb the surface; and
- (b) only make a sewer connection at an approved position.

286. A drain other than a subsoil drain, shall be constructed in a manner that ensures that—

Material used and construction of drain or private sewer.

- (a) the drain is constructed of approved materials;
- (b) where the soil may cause undue corrosion of cast iron or concrete pipes, the pipes are not used unless protected;
- (c) the drain is properly supported and protected against damage and provided with watertight joints and laid to a fall;
- (d) the drain when constructed, can withstand a reasonable hydraulic, smoke or air test under pressure, or another approved test;
- (e) the drain is of an approved size and has an internal diameter of at least 100mm; and
- (f) where a drain is laid under a building, —
  - (i) it is laid in a straight line or if this is impracticable, in a series of straight lines;
  - (ii) unless it is constructed of cast iron material, it is constructed of a material whose strength is in accordance with—
    - (A) KS 548 (Specification for precast concrete pipes and fittings for drainage, sewerage and culverts);
    - (B) KS 1251 (Specification for unreinforced concrete porous pipes for under drainage);
    - (C) KS ISO 1452-1 (Plastics piping systems for water supply and for buried and above-ground drainage and sewerage under pressure - Unplasticized poly (vinyl chloride (PVC-U) - Part 1: General);
    - (D) KS ISO 1452-2 (Plastics piping systems for water supply and for buried and above-ground drainage and sewerage under pressure - Unplasticized poly (vinyl chloride (PVC-U) - Part 2: Pipes);
    - (E) KS ISO 1452-3 (Plastics piping systems for water supply and for buried and above-ground drainage and sewerage under pressure - Unplasticized poly (vinyl chloride (PVC-U) - Part 3: Fittings);
    - (F) KS ISO 1452-4 (Plastics piping systems for water supply and for buried and above-ground drainage and sewerage under pressure - Unplasticized poly (vinyl chloride (PVC-U) - Part 4: Valves);

- (G) KS ISO 1452-5 (Plastics piping systems for water supply and for buried and above-ground drainage and sewerage under pressure - Unplasticized poly (vinyl chloride (PVC-U) - Part 5: Fitness for purpose of the system);
- (H) KS ISO 4435 (Plastics piping systems for non-pressure underground drainage and sewerage - Unplasticized poly (vinyl chloride) (PVC-U));
- (I) KS ISO 8773 (Plastics piping systems for non-pressure underground drainage and sewerage - Polypropylene (PP));
- (J) KS ISO 11296-4 (Plastics piping systems for renovation of underground non-pressure drainage and sewerage networks - Part 4: Lining with cured-in-place pipes);
- (K) KS ISO 21138-1 (Plastics piping systems for non-pressure underground drainage and sewerage - Structured - wall piping systems of unplasticized poly (vinyl chloride) (PVC-U), polypropylene (PP) and polyethylene (PE) Part 1: Material specification and performance criteria for pipes, fittings and systems);
- (L) KS ISO 21138-2 (Plastics piping systems for non-pressure underground drainage and sewerage - Structured - wall piping systems of unplasticized poly (vinyl chloride) (PVC-U), polypropylene (PP) and polyethylene (PE) Part 2: Pipes and fittings with smooth external surface, Type A); or
- (M) KS ISO 21138-3 (Plastics piping systems for non-pressure underground drainage and sewerage - Structured - wall piping systems of unplasticized poly (vinyl chloride) (PVC-U), polypropylene (PP) and polyethylene (PE) Part 3: Pipes and fittings with non-smooth external surface, Type B);

(iii) it is laid in the ground or supported throughout its length, and is completely surrounded with concrete of at least 50mm in thickness;

(iv) it has a means of access for inspection and rodding of its whole length, which means of access has a bolted airtight cover if within a building.

287. Every inlet to a drain other than a soil pipe, ventilating pipe, or waste stack used as a ventilating pipe, shall be properly trapped.

Inlet to drain to be trapped.

288. Where a drain, combined drain or sewer passes through or under a wall, suitable support for the wall shall be provided to prevent the wall from damaging the pipe.

Drain or sewer passing through or under a wall.

289. A connection between a tributary drain and another drain and a sewer, shall be such that—
- Tributary drain.
- (a) the tributary drain joins the other drain or sewer obliquely in the direction of flow of that other drain or sewer; and
  - (b) manholes shall join it at the invert level or a level not higher than the radius of the main drain or sewer above that level.
290. (1) A manhole shall be positioned so as to enable the whole length of the drain to be accessible for rodding.
- Manhole.
- (2) A manhole shall be provided at a point within the curtilage of the building, which is drained, and as near as practicable to the point of entry of the drain to the sewer.
291. (1) A drain conveying foul water from a building, shall be properly ventilated with at least one ventilating pipe of at least 75mm in diameter, situated as near as practicable to the building and as far as practicable from the point at which the drain empties into the sewer or other means of disposal.
- Ventilating pipe.
- (2) A ventilating pipe shall be provided at the upper extremity of every branch drain which exceeds 12m in length.
- (3) A soil pipe, or waste stack of approved dimensions and which is connected directly to a drain, shall serve as a ventilating pipe to the drain.
292. A ventilating pipe to a drain, and every soil pipe—
- Soil pipe or ventilating pipe.
- (a) shall be made of approved material;
  - (b) if the pipe is of cast iron, the thickness of metal in the pipe and fittings shall be at least—
    - (i) 5mm, if the diameter of the pipe does not exceed 100mm; and
    - (ii) 6mm, if the diameter of the pipe exceeds 100mm;
  - (c) shall be carried upwards to a height and position so as to prevent the escape of foul air from the pipe into a building;
  - (d) shall be fitted at its open end with a wire cage or other suitable cover made of durable material admitting the free passage of air;
  - (e) shall, after installation, withstand reasonable hydraulic smoke, or air test under pressure;
  - (f) shall not have a trap at its point of junction with the drain, or elsewhere, except, where necessary as part of the apparatus of a water closet or slop-sink;
  - (g) shall not have a bend, except, where unavoidable in which case the bend shall—
    - (i) have an obtuse angle as large as possible;

- (ii) have the largest practicable radius of curvature; and
- (iii) not change in any way the cross section of the pipe;
- (h) shall not have joints in soil pipes within the thickness of walls or floors;
- (i) shall be of cast iron or other approved material and have flanged joints or other approved airtight joints, fixed inside a duct fitted with access panels or otherwise encased or supported in an approved manner;
- (j) shall have an internal diameter that is not less than that of a pipe discharging into it, unless it is a waste pipe from urinals only whose internal diameter shall be at least 75mm; and
- (k) at the bend at the foot, shall rest in a solid bed of concrete.

293. (1) Except where a tributary drain connects a soil pipe with the main drain at a manhole, an access plate shall be provided at the foot of the soil pipe. Access.

(2) A bolted access plate shall be provided at a junction between a branch pipe and a soil pipe and between soil pipes.

294. (1) A waste pipe from a bath, sink (not being a slop sink), bidet, or lavatory basin, and every other pipe for carrying off waste water, including a waste pipe used as a ventilating pipe to a drain— Waste pipe.

- (a) shall have an internal diameter of not less than that of any pipe connecting it with the appliance it serves;
- (b) shall have means of access for cleaning, and shall be at least 40mm in diameter, and where it has a common waste pipe, it shall have a diameter of at least 50mm;
- (c) despite sub-paragraph (1) (b), if it receives the discharge from not more than two lavatory basins, may be of an internal diameter of 40mm; and
- (d) if it is more than 2m in length, shall have a trap, which shall be easily accessible for cleaning.

(2) At least two lavatory basins may be fixed in a range from discharging into a common waste pipe, provided that the common waste pipe (whatever its length) itself discharges through a trap and has a means of access for cleaning.

(3) If a waste pipe discharges into a soil pipe, ventilating pipe to a drain, or waste stack—

- (a) the quality of the pipes and the joints shall be in accordance with—
  - (i) KS ISO 3633 (plastics piping systems for soil and waste discharge (low and high temperature) inside buildings, Unplasticized poly (vinyl chloride) (PVC-U)); and
  - (ii) KS ISO 15874-1-5 (Plastics piping systems for hot and cold-water installations, polypropylene (PP) Part 1: General);



- (b) the waste pipe shall have an approved deep seal or anti-vac trap at each outlet from the appliance;
  - (c) the diameter of the waste pipe shall be greater than that of the trap leading into it; and
  - (d) a trap connected to a common waste pipe shall be protected from siphonage.
- (4) Where a waste pipe discharges into a drain otherwise than as specified in sub-paragraph (3), it shall—
- (a) discharge into the open air;
  - (b) be disconnected from the drain by a trapped gully fitted with a suitable grating; and
  - (c) discharge above the level of the water in the trap and not cause dampness in a wall or foundation of a building, except where waste water may be received into a trapped gully inside a building.

295. A provision shall be made in the lay-out of drains and soil pipes, waste pipes and ventilating pipes, as may be necessary to prevent under working conditions, the destruction of the water seal of any drain trap or trap of a soil or waste appliance.

Maintenance of water seal in trap.

296. For a water-closet constructed in connection with a building—

Water-closet.

- (a) the pan, basin or other receptacle, that forms part of the water-closet shall be made of a smooth and non- absorbent material, and of the shape, capacity and mode of construction, as to receive and contain sufficient quantity of water, and to allow all faecal matters to fall free of the sides directly into the water received and contained in the pan;
- (b) the flushing apparatus shall secure the prompt cleaning of the water closet pan; and
- (c) no part of the water closet pan, shall be directly connected with a pipe, other than a soil pipe, drain or flush pipe, leading from the flushing apparatus.

297. (1) A urinal constructed in connection with a building, shall be constructed in accordance with sub-paragraphs (2) and (3), and where a supply of water is laid on to the building, it shall be constructed in accordance with sub-paragraphs (4) and (5).

Urinal.

(2) A urinal shall have a slab stall, trough or a receptacle, which shall—

- (a) have a smooth non-absorbent surface;
- (b) have an outlet which, shall be fitted with an approved grating and trap; and
- (c) be so constructed as to facilitate cleaning.

(3) A urinal, shall have an apparatus which flushes and cleans the receptacles from a supply of clean water.

(4) A part of a basin or other receptacle, which forms part of a urinal, shall not be directly connected with a pipe other than a soil pipe, drain, or flush pipe leading from the flushing apparatus.

(5) The floor of a urinal, shall be impervious to moisture, and finished with a hard-wearing surface which can be easily cleaned and satisfactorily drained to a point within the compartment.

298. (1) An owner shall not construct a trough closet.

Trough closet.

(2) A room containing a trough closet shall be constructed so as to open directly to the external air.

(3) An automatic water flushing system of at least a 20l flush shall be provided for a trough closet.

299. (1) A fitted water closet shall have—

Floor water closet.

(a) the whole of the pan fixed above the level of the floor and shall be adequately secured;

(b) the pan provided with a seat of an approved type;

(c) the sides of the pan not be enclosed; and

(d) a floor that is finished with a smooth non-absorbent hard-wearing surface.

(2) The pan of a fitted water closet shall be—

(a) sunk such that the upper edge of the flushing rim is below the level of the floor and the joint between the flushing rim and the floor finish shall be made in an approved manner; and

(b) encased in cement concrete of at least 100mm in thickness.

(3) The floor of the water closet, shall be constructed of concrete of at least 100mm in thickness, be impervious to moisture, finished with a hard-wearing and cleanable surface and laid to fall such that a liquid will flow into the pan of the water closet.

(4) A smooth coved skirting shall be formed at the junction of the floor and wall.

300. (1) A dwelling shall have a bathroom of at least 2.5m<sup>2</sup> in area having a dimension of at least 900mm.

Bathroom.

(2) Where a floor trap is used in connection with a bathroom, the floor shall be constructed of cement concrete at least 75mm in thickness, be impervious to moisture and finished with a smooth surface.

(3) The walls of a bathroom for a height of at least 1200mm shall be impervious to moisture, finished with a smooth surface.

301. (1) A water closet which has a door that opens directly to the outside environment shall have a sufficient opening for lighting and ventilation of at least 10% of the floor area, as near to the ceiling as practicable and communicating directly with the external air.

Lighting and ventilation of water closet or urinal.

(2) A water closet whose door does not open directly to the outside environment shall be ventilated by—

- (a) providing a window, roof light or other approved opening which shall—
  - (i) open directly into the external air;
  - (ii) be constructed in such a manner that an area not less than one-twentieth of the floor area of the water closet may open; and
  - (iii) provide permanent ventilation directly connected to the external air of an area of at least 150mm<sup>2</sup>; or
- (b) providing a mechanical or another means of ventilation which provides at least three air changes per hour.

(3) Each cubicle forming part of a water closet shall be at least 1500mm x 750mm.

(4) A water closet shall not communicate directly with a room intended principally for human habitation (other than a bedroom or dressing room, or a room intended to be used solely by one occupant) or for the manufacture, preparation or storage of food for human consumption.

(5) If a water closet is in a domestic building it shall, if it communicates with a bedroom or a dressing room, and there is no other water closet in the building which does not so communicate, be so constructed that it can be entered otherwise than through the bedroom or dressing room.

(6) In this paragraph, the expression “water closet” includes a urinal constructed in connection with a building and a room, or its part which is partitioned or divided, into cubicles any of which contains a pan, if the partitions or divisions, are constructed in a manner that allows the free circulation of air throughout the room.

302. (1) A person shall not erect, or cause to be erected, a building over a sewer.

Building over sewer.

(2) A building constructed in contravention of sub-paragraph (1) shall be altered or pulled down, at the cost of the owner.

303. All effluent which on disposal is discharged into the environment or a public sewer shall be compliant with the Environment Management and Coordination Act, 1999.

Effluent entering the environment or public sewer. No. 9 of 1999.

304. Trade effluent, including manufacturing liquid waste, or other effluent shall not be discharged into a sewer, unless it has been treated in an approved manner.

Trade effluent.

305. (1) The occupier of premises from which trade effluent is discharged into a sewer shall construct, on the premises, a manhole connected to the pipe or channel conveying the effluent.

Manufacturing premises.

(2) An officer authorised by the approving authority shall have access to the manhole referred to in sub-paragraph (1) and may examine the trade effluent.

(3) A provision shall be made in a manufacturing plant to stabilise trade effluent before the trade effluent is discharged into a public sewer.

306. A person shall not dispose a matter or substance, which interferes with the free flow of sewage, or by which a sewer or drain may be damaged, throw into a sewer, or into a drain communicating with a sewer.

Matter not to be disposed in manner that damages sewer or drain.

307. (1) Sewage and waste water disposal other than through a sewer, may be by means of one or a combination of more than one of the means in Table 48 set out in the First Schedule.

Sewage and waste water disposal.

(2) A certificate setting out the results of a soil test for permeability shall be submitted to the relevant approving authority.

(3) A septic tank or biodigester provided in accordance with the means specified in Table 48 set out in the First Schedule shall be designed by an engineer.

308. (1) A septic tank and a soak pit shall have radial arms.

Radial arm.

(2) The disposal shall be arranged in a manner that does not cause pollution or a nuisance.

(3) The trenches forming radial arms shall be cut square, to proper gradients, level and filled with approved hardcore material, graded and at ground level, and be covered with fine materials of at least 22mm in depth.

309. (1) The capacity of a waste water storage tank shall not exceed 300l.

Waste water storage tank.

(2) An approved pump shall be fitted for emptying the tank unless gravity discharge is used.

(3) The access to the storage tank shall be provided through a medium weight hinged manhole cover made of cast iron or another approved material.

310. Waste water shall not be discharged by means of an open channel.

Prohibition of waste water into an open channel.

311. (1) The installation in a building of a roof gutter or downpipe where another suitable means has been provided to ensure the disposal or dispersal away from the building of rainwater from the roof of the building, is not required.

Exemption.

(2) This Part shall not apply to a construction site where construction works are being undertaken for only a dwelling house or a building appurtenant.

(3) Where, due to special features on a construction site, the discharge of storm-water from the construction site may cause significant damage, the approving authority may require compliance to additional conditions.

## PART XV—ELECTRICAL INSTALLATIONS

312. (1) Electrical installation work in a building shall be carried out in accordance with— Applicable laws.

- (a) the Energy Act, 2019; No. 1 of 2019.
- (b) KS 662 (Electrical Installations);
- (c) KS 1587 (National electrical safety code);
- (d) KS IEC 60947-1 (Specification for low-voltage switchgear and control gear - Part 1: General requirements);
- (e) KS IEC 60947-2 (Specification for low-voltage switchgear and control gear - Part 2: Circuit-breakers);
- (f) KS IEC 60947-3 (Specification for low-voltage switchgear and control gear - Part 3: Switches, disconnectors, switch disconnectors and fuse combinations);
- (g) KS IEC 60947-4 (Specification for low-voltage switchgear and control gear - Part 4: Contactors and motor-starters);
- (h) KS IEC 60947-5 (Specification for low-voltage switchgear and control gear - Part 5: Control circuit devices and switching elements);
- (i) KS IEC 61439-1 (Low-voltage switchgear and control gear assemblies);
- (j) KS IEC 61439-2 (Low-Voltage switchgear and control gear assemblies - Part 2: Power switchgear and control gear assemblies);
- (k) KS IEC 61439-3 (Low-voltage switchgear and control gear assemblies - Part 3: Distribution boards intended to be operated by ordinary persons (DBO));
- (l) KS IEC 61439-4 (Low-voltage switchgear and control gear assemblies - Part 4: Particular requirements for assemblies for construction sites (ACS));
- (m) KS IEC 61439-5 (Low-voltage switchgear and control gear assemblies Part 5: Assemblies for power distribution in public networks);
- (n) KS IEC 62208 (Empty enclosures for low-voltage switchgear and control gear assemblies - General requirements); or
- (o) BS 7671 (Requirements for Electrical Installations - IET Wiring Regulations).

(2) This Part shall not apply to a conductor, apparatus or appliance which does not form part of a building or fixture thereof, or an electrical system on a construction site.

313.(1) An electrical conductor or apparatus shall be of the size and current rating in accordance with BS 7671 (Requirements for Electrical Installations IET Wiring Regulations). Conductor or apparatus.

- (2) A conductor shall be installed accordance with the—
- (a) KS 178 (Glossary of terms related to cables, conductors and accessories for electricity supply);
  - (b) KS IEC 60228 (Conductors of insulated cables);
  - (c) KS 190-2 (Specification for stranded aluminium conductors steel reinforced and galvanized steel wire for reinforcing aluminium conductors - Part 2: Aluminium conductors steel reinforce);
  - (d) KS IEC 61386-1(Conduit systems for cable management - Part 1: General requirements);
  - (e) KS 308 (Specification for Ceiling Roses);
  - (f) KS IEC 61386-22 (Conduit systems for cable management - Part 22: Particular requirements - Pliable conduit systems);
  - (g) KS 1069 (Requirements for pvc covered conductors for overhead power lines);
  - (h) KS IEC 61386-23 (Conduit systems for cable management - Part 23: Particular requirements - Flexible conduit systems);
  - (i) KS IEC 61386-24 (Conduit systems for cable management - Part 24: Particular requirements - conduit systems buried underground); or
  - (j) KS IEC 61386-25 (Conduit systems for cable management - Part 25: Particular requirements - Conduit fixing devices)
- (3) A live conductor, including that forming part of an apparatus, shall be—
- (a) insulated and where necessary, further effectively protected; or
  - (b) placed and safeguarded in a manner that prevents danger as far as is reasonably practicable.
- (4) An electrical joint and connection shall be installed with respect to conductance, insulation, mechanical strength and protection, and shall be accessible for inspection and maintenance, and shall be in accordance with—
- (a) KS 180-1(Specification for metallic conduits);
  - (b) KS 180-2(Specification for Metallic Conduits and Fillings for Electrical Installations - Part 2: Fittings);
  - (c) KS 468-1(Specification for Flexible PVC Conduits for Electric Wiring. Part 1: Plain Conduits); or
  - (d) KS 179-2 (Non-metallic Conduits and Fittings Part 2: Specifications for Fittings).
- 314.(1) An electrical circuit and sub-circuit shall be protected against excess current by a fuse, circuit-breaker or another similar device which shall—

Fuse, switch or circuit-breaker.

- (a) operate automatically at current values related to the safe current ratings of the circuit;
- (b) have the breaking capacity designed by an engineer;
- (c) be located and constructed in a manner that prevents danger caused by overheating, arcing or the scatter of hot metal when in action; and
- (d) be in accordance with—
  - (i) KS 194 (Specification for PVC Insulated Cables for Electricity Supply - 2nd Revision);
  - (ii) KS 1230-3 (Specification for Low Frequency Cables and Wires with PVC Insulation and PVC Sheaths - Part 3: Equipment Wires);
  - (iii) KS 1230-4 (Specification for low frequency cables and wires with PVC insulation and PVC Sheaths - Part 4: Distribution Wires);
  - (iv) KS 1230-5 (Specification for Low Frequency Cables and Wires with PVC Insulation and PVC Sheaths - Part 5: Equipment Wires and Cables, Screened);
  - (v) KS 1230-7 (Specification for Low Frequency Cables and Wires with PVC Insulation and PVC Sheaths - Part 7: Distribution Wires, Polyamide Coated); or
  - (vi) KS IEC 60947-3 (Specification for Low Voltage Switchgear and Control gear - Part 3: Switches, Disconnectors, Switch Disconnectors and Fuse Combinations).

(2) Where an earth fault leakage current from a circuit is not sufficient to operate a fuse, circuit-breaker or another similar device, the circuit shall be protected by an earth leakage circuit-breaker or another similar device against the persistence of an earth current that is liable to cause danger.

(3) A fuse or circuit-breaker, other than a linked circuit-breaker, shall not be inserted in a conductor connected to earth, and a linked circuit-breaker shall be arranged in a manner that breaks a live conductor.

(4) A single pole switch shall only be inserted in a live conductor and shall be in accordance with KS EAS 495 (13A plugs, socket-outlets, adaptors and connection units).

315. Where metal, other than a current-carrying conductor, is likely to become charged with electricity in a manner that may create danger if the insulation of the conductor becomes defective, or if a defect occurs in an apparatus, the metal shall be earthed in accordance with BS 7671 (Requirements for Electrical Installations - IET Wiring Regulations).

Precautions  
against metal  
becoming  
charged.

316. (1) Means shall be provided for the immediate disconnection of voltage from a circuit, sub-circuit or apparatus.

Isolation of system or apparatus.

(2) An apparatus which requires operation or attention in normal use shall be installed in such a manner that means of access and working space are afforded for the operation or attention.

(3) A part of a building in which apparatus is placed shall be lighted to prevent danger.

(4) An electric motor having a rating that exceeds 0.37kW shall have control apparatus which affords protection against excess current in the motor, or in the cables between the device and the motor.

317. (1) An appliance shall be—

Connection of appliance to electricity supply.

(a) controlled by means of a switch, in addition to an automatic control device, and arranged in a manner that disconnects the appliance from a live conductor; or

(b) connected by means of a plug and socket outlet that is in accordance with—

(i) KS 1432-1 (Specification for Connecting Devices for low Voltage Circuits for Household and Similar Purposes - Part 1: General Requirements);

(ii) KS 1432-2 (Specification for Connecting Devices for Low Voltage Circuits for Household and Similar Purposes - Part 2: Particular Requirements for Connecting Devices with Screw - Type Clamping Units);

(iii) KS 1432-3 (Specification for Connecting Devices for Low Voltage Circuits for Household and Similar Purposes - Part 3: Particular Requirements for Twist-on Connecting Devices); or

(iv) KS 1432-4 (Specification for Connecting Devices for Low Voltage Circuits for Household and Similar Purposes - Part 4: Particular Requirements for Connecting Devices with Insulation Piercing Clamping Tool).

(2) This paragraph shall apply to an electric clock, a bell transformer or another similar appliance fed from a separate extra low voltage circuit.

(3) A heating appliance shall be controlled by a linked switch that is installed in a manner that breaks the electricity supply to a conductor.

318. (1) An apparatus or conductor—

Precautions against special condition.

(a) exposed to weather, corrosive atmosphere or another adverse condition, shall be constructed or protected in a manner that prevents deterioration or danger, from the exposure; and



- (b) which is or is likely to be exposed to flammable surroundings or an explosive atmosphere, shall be protected by a flameproof enclosure or be designed, constructed and installed in a manner that prevents danger.

(2) In sub-paragraph (1) a “flameproof enclosure” means an enclosure or casing which withstands, an explosion of a flammable gas without damage, which may occur and which can prevent the transmission of a flame that would ignite a flammable gas.

(3) A flammable installation shall be in accordance with KS IEC 60079 (Electrical Apparatus for Explosive Gas Atmospheres).

319. An apparatus or conductor operating at voltages between conductors, or to earth that exceeds 200v shall be completely enclosed in earthed metal which shall be electrically continuous and protected against mechanical damage or constructed, installed and protected in a manner that prevents danger

Voltage exceeding 200V.

320. A fixed electrical appliance shall—

Electrical appliance.

- (a) be designed, constructed and installed in such a manner that it operates efficiently, safely and in accordance with KS 1111 (Specification for Safety Requirements for Domestic and Similar Electrical Appliances); and
- (b) meets the Kenyan Standards on Minimum Energy Performance.

321. (1) A light fitting or another electrical apparatus or appliance, in a room containing a fixed bath or shower shall—

Light fitting, apparatus or appliance in room containing bath or shower.

- (a) be situated in such a manner that if it is accessible to person in the bath or shower, it is shrouded in insulating material;
- (b) be installed in a manner that ensures a part of a lamp-holder that is likely to be touched by a person replacing a lamp is constructed of, or shrouded in, insulating material;
- (c) be installed in a manner that ensures a switch, or another means of control or adjustment, associated with a light or electrical appliance in a room is—
- (i) of a type operated by an insulating pull-cord switch; and
- (ii) placed in an accessible position outside and immediately or adjacent to the normal access door of the room.

(2) A room may have a provision for a shaver supply unit which—

- (a) is installed in accordance with KS IEC 60335 (Household and similar electrical appliances - Safety);
- (b) is situated in a manner that if it is accessible to person in the bath or shower, it is shrouded in insulating material;

(c) has the earth terminal installed in accordance with paragraph 314; and

(d) has a secondary circuit that is isolated from both the main electricity supply and the earth terminal.

(3) In a room containing a bath or a shower, a provision shall not be made for the use of an electrical portable appliance other than a shaver.

322. (1) Except a building comprising a single dwelling house or part thereof, a building or part thereof shall, on a wall beside the main switch for that building or part thereof, display a schematic diagram, in a permanent form and showing the main distribution circuit and control of the wiring in the building.

Wiring diagram or distribution board.

(2) A switch or current breaker shall be labelled to indicate the apparatus it controls.

323. (1) In a building or part thereof, in which electricity is installed for lighting—

Electric lighting.

(a) the building shall have a system which comprises of at least one terminal point for lighting in every room that has a floor area of at least 2m<sup>2</sup>, and in every bathroom, water closet, entrance vestibule, hall, passage and staircase terminal landing; and

(b) the lighting of staircase terminal landings of the building, shall, unless an automatic switching device is installed, be controlled by switches at the landings and at any other terminal landing thereon.

(2) The lighting illumination level in an area within a building shall be in accordance with the Lighting Guide issued by the Chartered Institute of Building Services Engineers.

324. (1) In a building or part thereof, where an electricity point is installed, the electricity point shall be provided in a manner that is safe, under normal conditions of use of the attachment and use of a portable apparatus or appliance.

Electricity point.

(2) A socket outlet point shall be shuttered in accordance with KS 662 (Electrical Installations).

325. The means of earthing for lightning protection shall be in accordance with the code of practice for the protection of structures against lightning and KS 503 (Code of practice for the protection of structures against lightning).

Protection against lightning.

326. (1) A power house, meter board or boxes, shall be constructed to accommodate low voltage switchgears for a building and shall be situated where it is accessible by a power utility company.

Siting of power house.

(2) The low voltage switchgears shall be installed in accordance with KS IEC 62208 (Enclosures for low voltage switchgears & control gear assemblies) and KS 1587 (National electrical safety code).

(3) The siting of a standby generator, if required, shall be at a location where the noise level of the generator is in accordance with the Environmental Management and Coordination Act, 1999.

No. 9 of 1999.

327. A switch socket, an isolator, a consumer unit, distribution board, an electric bell, a television outlet and data outlet, in a building shall be installed in accordance with KS ISO 21542 (Building construction - Accessibility and usability of the built environment).

Location and position of electrical appliance.

328. (1) If a building has a master antenna television station system, it shall be installed in accordance with—

Telecommunication installation and other electrical installation.

- (a) KS IEC 60050-712 (International electrotechnical vocabulary (IEV) - Part 712: Antenna);
- (b) KS 1278 (Specification for external TV aerials in the frequency range 30 MHz to 1 GHz);
- (c) KS 1893-1 (Installation of communal and single antenna systems for the reception of television and sound broadcast transmissions - Code of practice - Part 1: VHF and UHF television and VHF sound antenna systems); or
- (d) KS 1893-2 (Installation of communal and single antenna systems for the reception of television and sound broadcast transmissions - Code of practice - Part 2: Satellite antenna systems).

(2) The alternative sources of energy in a building shall be installed in accordance with—

- (a) KS 1673 (Generic Specification for Solar Photovoltaic Systems);
- (b) KS 1674 (Crystalline Silicon Terrestrial Photovoltaic (PV) Modules);
- (c) KS 1675 (Solar Photovoltaic Power Systems-Design, Installation, Operation, Monitoring and Maintenance-Code of Practice, Part 1: General PV Systems Requirements);
- (d) KS 1676 (Terrestrial Photovoltaic (PV) Power Generating System);
- (e) KS 1677 (Procedures for Temperature and Irradiance Corrections to Measured I-V Characteristics of Crystalline Silicon Photovoltaic Devices);
- (f) KS 1678 (Photovoltaic Devices);
- (g) KS 1679 (UV Test for Photovoltaic (PV) Modules);
- (h) KS 1680 (Overvoltage Protection of Photovoltaic (PV) Power);
- (i) KS 1681 (Characteristics Parameters of Stand-alone Photovoltaic Module);
- (j) KS 1682 (Salt Mist Corrosion Testing of Photovoltaic (PV) Modules);

- (k) KS 1683 (Rating of Direct Coupled Photovoltaic (PV) Pumping);
  - (l) KS 1684 (Susceptibility of Photovoltaic (PV) Module to AC);
  - (m) KS 1685 (Photovoltaic System Performance Monitoring Guide);
  - (n) KS 1686 (Analytical Expressions for Daily Solar Profiles);
  - (o) KS 1687 (Photovoltaic (PV) Systems - Characteristics of the Utility Interface); or
  - (p) KS 1688 (Crystalline Silicon Photovoltaic (PV) Array – On-site Measurement of I-V Characteristics).
- (3) The access and closed-circuit television security surveillance system in a building shall be installed in accordance with the required safety requirements and—
- (a) KS 2110 (Installation and remote monitoring of detector activated CCTV systems);
  - (b) KS 2109 (Closed circuit television (CCTV) - Management and operation - Code of practice);
  - (c) KS 2112-3 (Electrical security installations - Part 3: Electrical security fences (non-lethal));
  - (d) KS IEC 60335-2-76 (Household and similar electrical appliances-Safety - Part 2-76: Particular requirements for electric fence energizers).
  - (e) KS IEC 61011-1 (Electric fence energizers - Part 1: Safety requirements for battery-operated electric fence energizers suitable for connection to the supply mains); or
  - (f) KS IEC 61011-2 (Electric fence energizers - Part 2: Safety requirements for battery-operated electric fence energizers not for connection to the supply mains).
- (4) The structured cabling installed in a building shall be installed in accordance with—
- (a) KS ISO IEC 15018 (Information Technology - Generic Cabling for Homes); or
  - (b) KS ISO IEC 14763-3 (Information Technology - Implementation and Operation of Customer Premises Cabling: Part 3 - Testing of Optical Fibre Cabling).
- (5) An intruder alarm system in building shall be installed in accordance with KS 111 (Intruder alarm systems in buildings).
- (6) The telecommunication installation in a building shall have—
- (a) at least one network termination point within each dwelling unit with ducting for the network termination point;
  - (b) a telecommunication service duct that is separate from other utility ducts;

- (c) a cabinet or enclosure for installation of telecommunications equipment; and
- (d) a common entry duct that is connected from within the building to an access point that is installed beyond the boundary of the construction site.

(7) The telecommunication installation in a building shall be designed and installed in accordance to KS 1882-1 (Installation of telecommunication cables – Code of practice - Part I: Fibre optic cable in buildings).

#### PART XVI—LANDSCAPING

329.(1) An owner shall provide for a soft landscape at the construction site when engaging in construction works.

Landscape design considerations.

(2) The soft landscape referred to in sub-paragraph (1) shall be at least fifty percent of the open area of a construction site when engaging in construction works.

(3) The design of the soft landscape referred to in sub-paragraph (1) shall be prepared by an architect, and shall—

- (a) contain notes detailing the relevant planting setback requirements;
- (b) illustrate an existing and proposed, above and below grade, utility alignments or fixture, such as utility pedestal, fixture, art installation, monument, statue, road light, walkway light, signage, amenity, catch basin, manhole, high, intermediate or low-pressure lines, overhead power line, pylon or sewer;
- (c) contain detailed notes that outline the precautionary requirements that are necessary for excavation, or notification of utility service providers before construction; and
- (d) outline architectural, structural, mechanical and electrical aspects.

(4) The details referred to in sub-paragraph (3) shall be within the same drawing.

330.(1) If the scale and scope of a planting design included in one drawing, the design of the soft landscape referred to in paragraph 329 may include a landscape planting design.

Landscape planting design.

(2) The landscape planting design referred to in sub-paragraph (1) shall contain—

- (a) an illustration of an existing tree, shrub, shrub bed, or natural area, that is to be preserved, or the proposed relocations thereof;
- (b) the type or botanical name, of a plant and the planting quantity requirements in tabular form, based on the area in square metres;

- (c) the proposed location for a tree, shrub, perennial or ground cover, that is clearly labelled, and cross-referenced to the plant list;
- (d) notes detailing a seed or sod mix, where a seed mix note shall include the standard application rates;
- (e) a typical and applicable planting detail, and a unique planting installation, road island and median cross section planting installation detail; and
- (f) a planting design that shall identify a proposed surface treatment and any other application.

331.(1) A tree planted shall be in accordance with in Table 49, Table 50 and Table 51 set out in the First Schedule, except where a special construction mitigation measure has been put in place for a root barrier.

Provision for tree or shrub.

- (2) A setback for a shrub from the edge of a shrub bed shall—
  - (a) reflect mature diameter with the entire shrub contained in the bed;
  - (b) ensure mature spread cannot encroach on the sidewalk or onto fences; and
  - (c) be at least 500mm from the edge of the bed or fence or sidewalk from the mature spread of the shrub.

(3) The location of a planting bed shall accommodate the use of large turf maintenance equipment and provide a clearance of at least 2.5m between the edge of the bed and an obstruction such as fencing, furniture, a building, or an individual tree.

(4) Where possible, a shrub bed shall be designed with tapered or flowing edges, without 90o corners, to allow for ease of mowing, eliminate the need for hand trimming and ensure there is turf between planting beds and adjacent fences, whose distance shall be at least 2.5m.

(5) On a drawing, a shrub symbol shall be shown at mature size with no overlap, provided the ground covers symbols may be overlapped.

(6) A setback for a shrub shall achieve a balance between aesthetic impact, shrub health and maintenance concerns.

(7) There shall be a planting setback of at least 3m for a shrub bed from a playground envelope, with the design preference being naturalized planting.

(8) On a construction site which is to contain a school playground, a shrub bed shall not be planted within 30m of the playground envelope, and the design preference shall be naturalized planting

(9) The quantity of trees and shrubs shall be planted so as to be appropriate for an open space.

(10) Shrubs may be planted in place of trees to a maximum of 10% of number of trees prescribed under sub-paragraph (2) on which construction site.

(11) In this paragraph, a “playground envelope” includes playground equipment and a splash park.

332. (1) A deciduous tree planted shall have a minimum calliper of 50mm and a coniferous tree shall have a height of 2m.

Minimum size of tree and shrub.

(2) A person may plant a mix of deciduous and coniferous trees, where practicable.

(3) If a proposed tree has a calliper that is less than 50mm, additional plant material may be planted.

(4) Minimum shrub spacing shall be based on spread at maturity.

(5) With the exception of a naturalization area, shrub size at planting shall be a minimum of 300mm height for deciduous shrubs and a spread of 450mm for coniferous shrubs.

333. An owner shall maintain the soft landscape referred to in paragraph 329 after the completion of construction works.

Maintenance of soft landscape.

334. Furniture and fixtures shall be incorporated in to the design of the soft landscape referred to in paragraph 329.

Furniture and fixture in design of soft landscape.

#### PART XVII—INSPECTION AND MAINTENANCE

335. An inspection of a building shall be conducted within every five years after the completion of a building.

Periodic inspection of a building.

336. (1) The following types of inspections shall be carried out on a building—

Procedure for building inspection.

- (a) a visual inspection;
- (b) a full structural or civil inspection;
- (c) a full building condition survey;
- (d) a full building services (electrical and mechanical) inspection; and
- (e) a specialized building investigation.

(2) A licensed building surveyor shall carry out the inspection referred to in sub-paragraph (1) (c).

(3) A licenced building surveyor shall coordinate the inspections referred to in sub-paragraph (1).

(4) An inspection referred to in sub-paragraph (1), except a full building services (electrical and mechanical) inspection, shall be carried out in the first instance and subsequent inspections after the issuance of a certificate of occupation for a building.

(5) An inspection referred to in sub-paragraph (1) (a) shall consider—

- (a) a visual observation of the condition of a building, its structural elements and an addition or alteration to the building and its structural elements; and
- (b) a visual observation of the surrounding areas including the slopes and drainage system and an alteration to the slope structures.

(6) A building surveyor shall submit to an owner the visual inspection report prepared pursuant to an inspection conducted in accordance with sub-paragraph (5).

(7) The visual inspection report referred to in sub-paragraph (6) may recommend that the inspection referred to in sub-paragraph (1) (b), (c) and (d) be carried out and shall specify—

- (a) that the information relating to the design, construction, maintenance and history of the building shall be obtained;
- (b) reasonable due diligence, checking the structural plans of the building and related calculation or, if the plans are not available, reconstruct the structural plans;
- (c) the carrying out of non-destructive tests;
- (d) the carrying out of tests on the materials used in the construction of the buildings; and
- (e) recommendations that involve a professional carrying out of remedial works necessary to ensure the structural condition, stability or integrity of the building.

337.(1) Remedial works shall be classified as building works for purposes of this Code and the remedial works shall include—

Implementation of remedial works.

- (a) the replacement of corroded reinforcement bars;
- (b) the reconstruction of a main water tank; and
- (c) rewiring and underpinning works.

(2) Remedial works shall be classified as building works for the purposes of this Code and the remedial works shall be undertaken in accordance with the recommendations made under paragraph 335.

(3) A registered professional undertaking an inspection after remedial works have been done shall prepare and submit the inspection report in accordance with paragraph 335.

#### PART XVIII— NON-WATER BORNE WASTE DISPOSAL

338. Where non-water borne sewage disposal is not available, the owner shall provide other means of non-water borne sewage disposal.

Means of disposal.

339. (1) A person shall not construct a pit latrine in an urban area unless approved by the approving authority.

Prohibition of pit latrines.



- (2) Notwithstanding subparagraph (1) a temporary latrine shall be constructed at a construction site in accordance with the Public Health (Drainage and Latrine) Rules. Sub. Leg. L.N. 138/1959.
340. (1) The means of sewage disposal referred to in paragraph 337 shall be constructed, situated and provided in such a manner that enables access, and that ensures that the health and convenience of persons using the means are not adversely affected. Construction, siting and access.
- (2) The number of sanitary receptacles for the purposes of this Part shall be in accordance with the Public Health (Drainage and Latrine) Rules. Sub. Leg. L.N. 138/1959.
- (3) Every institution shall have the ratio of latrines of at least 3:1 in favour of females to males.
341. (1) A closet shall be constructed with a floor, walls and a roof, and the closet shall have a door, or other means, which shall ensure privacy of the occupant of the closet. Construction of closet.
- (2) A closet shall have an opening which shall enable natural lighting and ventilation, and the area of the opening shall be at least 0.2m<sup>2</sup>.
- (3) A closet shall have a seat and a riser whose height ensures that a space that does not exceed 25mm is left between the underside of the seat and the top of the receptacle.
- (4) The aperture in the seat referred to in sub-paragraph (3) shall be at least 25mm less in diameter than the corresponding diameter of the top of the receptacle and the aperture shall be fitted with a self-closing fly proof lid.
342. (1) An excavation for a pit latrine shall not be situated within 3m of a building, or of a boundary. Siting of pit latrine.
- (2) Where an excavation for a pit latrine is positioned outside the closet such that excreta is delivered into it from a chute fitted under the closet seat, the excavation shall be covered over in accordance with the Public Health (Drainage and Latrine) Rules. Sub. Leg. L.N. 138/1959.
- (3) A latrine shall not open directly into a habitable room.
- (4) A latrine shall have an opening which has direct access to the open air or from a permanently ventilated space.
343. (1) A latrine and an ablution, shall be provided as separate compartments, in which case each compartment shall have minimum dimensions of 1350mm by 750mm, or as a combined compartment having a minimum area of 1.350m<sup>2</sup>. Latrine or ablution.
- (2) Where a combined compartment is provided in accordance with sub-paragraph (1), a separate provision for the washing of utensils shall be provided.
- (3) The walls of a combined compartment referred to in sub-paragraph (1) shall have a smooth surface to a height of at least 1350mm above the floor level and the floor shall be finished with a smooth surface and laid to a proper fall.

(4) The junction between the floor and the wall shall be formed with a cement cove or similar construction, of a radius of at least 37.5mm.

(5) A family or group, which does not exceed twelve persons, shall have one latrine and one ablution, or a combined compartment in accordance with sub-paragraph (2).

#### PART XIX—REFUSE DISPOSAL

344. (1) Every building shall have an approved means of refuse storage and disposal.

Provision for refuse disposal.

(2) A person carrying out refuse collection services shall comply with this Part.

345. An area designated for refuse storage or disposal shall be located such that it can be accessed from a road for the purpose of removing the refuse.

Access to area designated for refuse disposal.

346. (1) In a low-rise residential building, a dwelling shall have, or have access to, a movable waste container with a capacity of at least 0.125m<sup>3</sup>, or a communal waste container of a capacity that is between 0.75 m<sup>3</sup> and 1m<sup>3</sup>.

Waste container for building.

(2) In a multi-storey residential building, each dwelling up to the fourth storey may have its own waste container, or share a waste container.

(3) In a multi-storey residential building, a dwelling that is situated above the fourth storey shall share a container that is fed by a chute.

(4) Where the siting or operation of the chute referred to in sub-paragraph (3) is impracticable, a management arrangement for conveying refuse to the waste container shall be provided.

(5) A waste container shall have a close-fitting lid.

(6) If a waste container is placed in an enclosure, the enclosure shall—

- (a) allow room for filling and emptying;
- (b) provide a clear space of 150mm between and around the container and if it is a communal container, have a height of at least 2m; and
- (c) be permanently ventilated at the top and at the bottom.

(7) Where the number of people occupying a building prevents the provision of a system of refuse storage or disposal, the owner shall consult the approving authority on—

- (a) the volume and nature of the waste and the storage capacity required, based on the frequency of collection and the size and type of container;
- (b) the method of storage, including any proposed on-site treatment related to the intended layout and building occupancy;

- (c) the location of storage and treatment areas and the access to them for operatives and vehicles;
- (d) hygiene arrangements in the storage and treatment areas; and
- (e) fire hazards and protection measures.

(8) In this paragraph “low-rise residential building” means a residential building of which the floor of the uppermost storey does not exceed 10m from the ground level.

347. (1) A waste container or a refuse chute shall be situated in a manner that ensures that—

Waste container and chute.

- (a) an occupant does not carry refuse farther than 30m; and
- (b) the container is within 25m of the motor vehicle access.

(2) A waste container shall be situated in a manner that ensures it can be collected without being taken through a building, unless the building has a garage or another open or uncovered space.

348. (1) A design relating to a residential, non-residential or a composite building, shall be made in accordance with Table 52 set out in the First Schedule in relation to the minimum floor space requirements for storage chambers.

Storage chamber.

(2) Where a storage chamber is provided in a building it shall be designed in accordance with this Part.

(3) A storage chamber shall be designed and located in such a manner that the storage chamber provides access to remove a waste container.

(4) Where access to a storage chamber, other than for motor vehicle access is along a passage, alley or similar way, the access shall be at least 1.5m in width and have a longitudinal gradient that does not exceed 1 in 20, paved and without a staircase.

(5) A storage chamber shall not have an opening, except for—

- (a) an access referred to in sub-paragraph (3); and
- (b) a refuse chute or a hopper.

(6) At least one of the walls of a storage chamber shall be an external wall.

(7) A storage chamber shall have a dimension at least 1.5m.

(8) The height, measured to the ceiling, of a storage chamber shall, throughout the chamber, be at least 2.0m.

(9) A storage chamber shall be constructed of brickwork, concrete or another approved material.

(10) The internal face of the walls and ceiling of a storage chamber shall be lined with smooth impervious material.

(11) The floor of a storage chamber shall be—

- (a) made of approved hard impervious and smooth material;
- (b) laid to fall towards the gully provided in accordance with this Part; and
- (c) finished with approved hard impervious material.

(12) In a storage chamber, the junction of the floor with the walls shall be coved.

(13) A storage chamber shall have a close-fitting door made of steel, or other suitable material, and the door shall—

- (a) be situated in an external wall of the storage chamber;
- (b) have a height of at least 1.8m;
- (c) have a width of at least 1.25m;
- (d) have a lock, or other means of preventing persons obtaining access to the storage chamber; and
- (e) have a smooth internal surface without projections.

(14) Every storage chamber shall be provided, in the floor thereof, with an outlet drain which shall be provided with a grating and connected, by means of a pipe having an internal diameter of at least 100mm, to a back inlet trapped gully which shall be—

- (a) situated immediately outside the storage chamber;
- (b) fitted with an airtight cover to provide access to the gully for inspection and cleaning; and
- (c) connected to a drain provided for the carriage of foul water.

(15) There shall be provided, in a storage chamber, a water supply point for the purpose of cleaning the chamber.

(16) The water supply point referred to in sub-paragraph (7) shall be connected to the supply of water provided for flushing the soil fitments in the building for which the storage chamber is provided.

349. (1) Where a refuse chute is provided in any building, it shall be designed to— Refuse chute.

- (a) be vertical, except as specified under sub-paragraph (2);
- (b) terminate at its lower level in a storage chamber; and
- (c) be in accordance with this Part.

(2) A refuse chute shall not have a bend or offset, except at its foot or above the level of the highest hopper.

(3) Where a refuse chute has an offset at the foot, the offset shall have a slope of at least 60° to the horizontal and be constructed of replaceable galvanized or stainless steel of at least 3mm in thickness.

(4) The top of a refuse chute shall be at least 300mm above the top of the highest hopper.

(5) A refuse chute shall have an internal diameter of at least 450mm.

(6) The walls of a refuse chute shall be constructed of smooth impervious material.

(7) A refuse chute shall be provided, at its lower end, with a galvanized or stainless-steel shutter, or plastic shutter, or constructed in a manner that enables the chute to be closed when necessary.

(8) A refuse chute shall have a ventilating pipe at the top, and the ventilating pipe shall—

- (a) have an internal area of at least 0.05m<sup>2</sup>;
- (b) be constructed from the top of the refuse chute to a height above the roof of the building of at least 1m;
- (c) at the end of the ventilating pipe, have a grating or grille that has apertures of an aggregate area that is at least that of the sectional area of the pipe; and
- (d) have an aperture whose dimension does not exceed 10mm.

(9) A refuse chute shall be provided, above the level of the highest hopper, with an access opening, that is at least 225mm in diameter, for inspection and cleaning of the chute.

(10) The access opening referred to in sub-paragraph (9) shall have a close-fitting metal shutter.

(11) The internal surface of a refuse chute shall be smooth, fire resistant, impervious and shall be formed of, or lined with, glazed ware or other approved material.

(12) Where a surface is constructed in accordance with sub-paragraph (11) a pipe shall be jointed using cement mortar in the proportion of one volume of cement, to one volume of sand or other approved material and be securely and solidly bedded into the walls of the chute.

350. (1) A hopper shall be situated in a place that is permanently ventilated to the open air.

Construction and situation of hopper.

(2) The opening on the wall of the building to provide access to a hopper shall have a clear opening which has dimensions of at least 250mm x 150mm and that do not exceed 350 x 250 mm.

(3) A hopper shall be constructed in such a manner that—

- (a) it remains in a completely closed, or completely open position;
- (b) it does not open of its own accord; and
- (c) prevents the escape of dust or fumes both when it is closed and when it is open.

(4) A hopper and frame shall be constructed in such a manner that prevents the refuse from becoming lodged therein.

(5) A hopper and frame shall be constructed of galvanized or stainless mild steel plate, of at least 3mm in thickness, or other approved material.

(6) The inner plate of a hopper shall project downward at an angle of at least 45° to the horizontal when the hopper is closed.

(7) The recess into which a hopper is fitted shall be of a size that houses the frame and the moving parts of the hopper in a manner that ensures no part of the frame or hopper projects into the refuse chute.

(8) The junction of a hopper with a refuse chute shall be made in a manner that provides a continuous smooth, fire resistant and impervious surface.

351. (1) A service room containing an incinerator shall be separated from the remainder of the building by a fire separation that has a fire-resistance rating of at least two hours.

Incinerator.

(2) The design, construction, installation and alteration of each indoor incinerator shall be in accordance with the Environmental Management and Co-ordination Act, 1999.

No. 9 of 1999.

(3) Every incinerator shall be connected to a chimney flue that serves no other appliance.

(4) An incinerator shall not be located in a room with another fuel-fired appliance.

#### PART XX—PEOPLE LIVING WITH DISABILITIES

352.(1) A building shall be designed in a manner that facilitates access to the building, and to the use of its facilities, by a person living with a disability in accordance with KS ISO 21542 (Building construction -Accessibility and usability of the built environment).

Building plan design.

(2) A public space shall have a wayfinding system with warning cues and auditory signals.

353.(1) Access for a person living with a disability shall be provided from a point on the boundary to at least one entrance, and to a lift that is installed in accordance with paragraph 355.

Initial access.

(2) The access referred to in sub-paragraph (1) shall not have a step, kerb (other than a dropped kerb), steep ramp, door or doorway which would impede the passage of a wheel chair, or other form of barrier which would prevent access by a person living with a disability.

(3) Where a garage is provided, at least one parking space or one percent of the parking spaces, whichever is more, shall be accessible from the access referred to in sub-paragraph (1).

(4) The provision for parking space for a person living with a disability shall be in accordance with KS ISO 21542 (Building construction — Accessibility and usability of the built environment).

354.(1) A ramp shall be provided where there is a change in the level, other than when the change in the level is served by a lift.

Ramp.

(2) The ramp referred to in sub-paragraph (1) shall be designed in such a manner that ensures that—

- (a) the ramp is at least 1.5m wide;
- (b) a space of at least 1.5m<sup>2</sup> is provided at the head and foot of the ramp;
- (c) if the ramp has a gradient of at least 1 in 20, a landing that is 1.5m long is provided for each 10m length of horizontal run, or part thereof;
- (d) if the ramp has a rise that exceeds 200mm, leading down towards an area where access to motor vehicle traffic is possible, it has a railing across the full width of its lower end that is at least 1.5m from the foot of the ramp;
- (e) ramp has a kerb gradient that does not exceed 1 in 12;
- (f) the ramp is provided with handrails on both sides; and
- (g) the supports of the ramp do not cause an obstruction to a height of 700mm above the level of the ramp.

355.(1) A change in level at a kerb shall be provided with a dropped kerb. Dropped kerb.

(2) A dropped kerb shall be provided at a pedestrian crossing and at each end of a footpath of a private road or access road.

(3) A kerb that separates a footpath or a ramp from an area accessed by motor vehicles areas shall have a dropped kerb.

(4) A dropped kerb shall be constructed in a manner that ensures that—

- (a) the length of the dropped kerb is at least 1.2m;
- (b) the pavement at the dropped kerb has a ramp whose gradient is less than 1 in 6 and has a space of at least 800mm in width at the back of the ramp; and
- (c) a kerb adjoining the dropped kerb shall have a ramp whose gradient is less than 1 in 6.

356. Access for a person living with a disability shall be provided to every floor of the building by at least one lift which has— Lift.

- (a) dimensions of at least 1.2m by 1.1m;
- (b) a clear door width when opened of at least 900mm;
- (c) essential lift control buttons or switches, installed at a height of between 900mm and 1.2m above the floor of the car and modified for use by a person who is visually impaired; and
- (d) handrails extending to within 150mm of the corners at the rear and sides of the car.

357.(1) Space shall be allowed for manoeuvring a wheelchair in a lobby, path or a similar area in a manner that ensures— Corridor or lobby.

- (a) the area has a clear width of at least 1.2m;
- (b) a space of at least 1.5m<sup>2</sup> is provided at or within 3.5m of every dead end;
- (c) the lobby in a corridor is at least 1.2m long, excluding space for door swings;
- (d) a level area, that extends for at least 1.2m beyond the space for door swings and that is at least 1.5m wide, on both sides of every entrance.

(2) This paragraph shall not apply to a lobby that leads only to a staircase.

358. A door used, or intended to be used, by a person living with a disability shall be installed in a manner that ensures—

Door.

- (a) the door, including, a one-leaf of a pair of double doors, has a clear width of at least 750mm between the open door and opposite jamb or another leaf;
- (b) the unobstructed area adjacent to the door handle on the leading face of a single door is at least 380mm wide;
- (c) the door, if installed within 380mm from the corner of a room, swings from the side nearer that corner;
- (d) if the door is a double-action self-closing door, it has a check mechanism to prevent the doors swinging beyond the closed position, has a transparent panel with the bottom edge that does not exceed 1m, and has a top edge that is at least 1.5m above floor level;
- (e) the door handles are installed at between 900mm and 1.05m above floor level, measured from the top surface of the grip; and
- (f) the door thresholds do not exceed 25mm in height.

359. (1) The minimum number of water closet cubicles used, or intended to be used, by a person living with a disability on each floor level, or on that part of a floor level which is designed for access by a person living with a disability, shall be installed in such a manner that there is one water closet cubicle provided where the total number of water closet cubicles provided on a level does not exceed twenty, or two water closet cubicles where the number of water closet cubicles exceeds twenty.

Water closet cubicle.

(2) Where water closet cubicles used, or intended to be used, by a person living with a disability, are accessible from a corridor, the number of the cubicles shall be based on the number of water closets on the floor level of the corridor, or that part of the floor level which is designed for access by a person living with a disability.

(3) Where water closet cubicles used, or intended to be used, by a person living with a disability, are accessible through a room with multiple cubicles, the number of the cubicles for each sex shall be



based on the number of water closet cubicles for each sex on the floor level of that room, or that part of a floor level which is designed for access by a person living with a disability.

(4) A water closet cubicle which is intended to be used, by a person living with a disability shall be situated in a part of a building which is constructed in accordance with this paragraph.

(5) The cubicle referred to in sub-paragraph (4) shall be accessible, if situated within a room containing other cubicles, through a clear space of at least 1.5m<sup>2</sup> in front of the cubicle to allow manoeuvrability, or by direct approach where no turning of the wheel chair is necessary.

360. (1) A handrail on a ramp shall be fixed at a distance of between 30mm and 50mm clear of a wall, and additionally or alternatively, other obstructions, and with a clear height of 70 mm from the top of the bracket to the top of the handrail. Handrail.

(2) The top of a handrail shall be at a height of between 850mm and 1m above a nosing, floor or landing level.

(3) A handrail shall extend horizontally for at least 300mm beyond the first and last nosing of every flight of a staircase or beyond the ends of a ramp.

361. (1) An auditorium of a building with a space that is used, or intended to be used, for a public function, shall be provided, at a spectator level, with one wheelchair space for every four hundred seats, or part thereof, in the auditorium. Wheelchair space.

(2) A wheelchair space shall be a rectangle measuring 760mm x 1.37m, where the side measuring 760mm being toward the stage, podium or screen.

362. A building whose occupancy is classified as H1 as specified in Table 1 set out in the First Schedule shall provide at least two rooms, or 5% of the total number of rooms, with the facilities that can accommodate a person living with a disability. Guest room.

#### PART XXI—FIRE SAFETY AND FIRE INSTALLATIONS

363. (1) A building shall be designed, constructed and equipped in a manner that ensures that in case of a fire— Fire safety.

- (a) the protection of occupants therein is ensured and that protection provides for the safe evacuation of the occupants;
- (b) the spread and intensity of the fire within the building and the spread of fire to another building is minimized; and
- (c) sufficient stability is retained to ensure that the building does not endanger another building.

(2) The design of a multi-storey building shall provide for—

- (a) the generation and spread of smoke are minimized and controlled to the extent that is reasonably practicable, and

- (b) means of access and equipment for detecting, fighting, controlling and extinguishing fire.

(3) Sub-paragraph (1) shall be satisfied where the design, construction and equipment of a building are in accordance with BS 9999 (Code of Practice for Fire Safety Design, Management and Use of Buildings) for fire safety in the design, management and use of buildings code of practice.

(4) The owner of a building shall comply with the approved fire safety standards.

364. (1) A building whose occupation is not classified as H3 or H4 set out in Table 1 set out in the First Schedule, and exceeds six storeys in height shall have at least one lift that is designed and installed to be used by firefighters.

Firefighting lift.

(2) A building—

- (a) in which an industrial undertaking is being, or intends to be, carried on; or
- (b) which is used, or intended to be used, for bulk storage or as a warehouse, and which exceeds a height of 30m, or a cubical extent of 7000m<sup>2</sup>,

shall have the number of firefighter's lifts that ensures any part of a storey that served by the lift is not located at a distance that exceeds 60m from the lift.

(3) A firefighting lift shall be—

- (a) designed and installed to serve at least every alternate storey of a building;
- (b) of a size, and whose doors, that can accommodate firefighters and firefighting equipment;
- (c) enclosed by a lift-well that encloses no more than three firefighting lifts and no other lifts;
- (d) designed and installed in a manner that, in the event of a fire, a firefighter using the lift is protected from fire and smoke, particularly when leaving the lifts; and
- (e) designed and installed in a manner that in the event of a fire, a firefighter can gain exclusive control and operation of the lift with their equipment.

(4) This paragraph shall not apply to a building—

- (a) provided with only one staircase;
- (b) that does not exceed six storeys in height;
- (c) in which the level of the floor of the uppermost storey does not exceed 17m above the level of the ground at the point of discharge of the staircase; or

- (d) that does not exceed a height of 30m or a cubical extent of 7000m<sup>2</sup> and in which no industrial undertaking is being, or is intended to be, carried on and which is not used, or intended to be used, for bulk storage or as a warehouse, place of public entertainment, hotel or hospital.

(5) In this paragraph “cubicle extent” in relation to a building, means—

- (a) the space contained within the external surfaces of its walls and roof and the upper surface of the floor of its lowest storey, but does not include a space within an enclosure on the roof that is used exclusively for accommodating a water tank, lift gear or another service; and
- (b) if a side of a building is not enclosed by a wall, that side shall be deemed to be enclosed by a wall extending downwards from the outer edge of the roof.

365. (1) A building or basement shall have the number of firefighting and rescue staircases that are sufficient to ensure each staircase is located within 60m of any part of the building, including a basement.

Firefighting and rescue staircase.

(2) A firefighting and rescue staircase shall be so designed and constructed that, in the event of a fire, a firefighter is able to have safe and unobstructed access and if the roof is accessible by a staircase, to the roof; and the staircase is protected from fire and smoke.

(3) This paragraph shall apply to every building exceeding—

- (a) a height of 30m;
- (b) a cubical extent of 7000m<sup>2</sup> height of one storey, in which an industrial undertaking is being, or is intended to be carried on or which is used, or is intended to be used for bulk storage or as a warehouse; or
- (c) every basement exceeding a cubical extent of 7000m<sup>2</sup> and a height of two storeys.

366. (1) The external wall of a small house shall—

- (a) be constructed in accordance with the requirements of non-combustibility and fire resistance in the second column of Table 53 set out in the First Schedule; and
- (b) have a resistance to internal fire of thirty minutes.

Fire resistance in small house.

(2) The conditions of the test specified in KS 566 (Specification for Fire Resistance Tests Elements of Building Construction) shall not apply to the determination of the resistance specified in sub-paragraph (1)(b).

(3) Subject to sub-paragraph (4), a building comprising of at least two small houses, shall have a non-combustible wall separating the houses, with a fire resistance of one hour.

(4) Where the external walls of a building comprising at least two small houses have combustible external panels of covering, the walls separating successive groups of not more than two of the houses shall—

- (a) have a fire resistance of two hours;
- (b) extend for at least 225mm beyond the outer surface of the external wall; and
- (c) unless the roof is of solid or hollow slab construction of non-combustible material, be carried for at least 380mm above the roof (measured at right angles to the slope).

(5) Where the external walls of a building comprising more than four small houses have combustible frames but non-combustible external panels or covering, the walls separating successive groups that do not exceed four of houses shall have a fire resistance of two hours and no part of the combustible construction of the external walls shall extend across the ends of the separating walls.

(6) Where the external wall, including an external panel or covering, of a building comprising more than eight small houses are non-combustible, the wall separating successive groups that do not exceed eight houses, shall have a fire resistance of two hours.

(7) Combustible material shall not be built into, or carried through or over, a separating wall except—

- (a) the ends of wooden beams, joists or purlins which are properly protected by brickwork or other solid and non-combustible material which is at least 100mm thick, or by a beam box of iron or other suitable non-combustible material; and
- (b) a tiling or slating batten that is embedded in mortar or other suitable material.

(8) Where a separating wall to which sub-paragraph (2) relates is not carried up above the underside of the covering of the roof, the slates or other covering or slab shall, where practicable, be properly and solidly bedded in mortar on the top of the wall.

(9) In a small house of two storeys, the upper storey shall be constructed in a manner that—

- (a) satisfies the test for fire resistance specified in KS 566 (Specification for Fire Resistance Tests – Elements of Building Construction);
- (b) resists collapsing for thirty minutes, and the rise of temperature; and
- (c) resists cracks or similar failures for fifteen minutes.

(10) The external wall of a building, other than the external wall of a small house, shall be non-combustible and have a fire resistance that exceeds two hours.

367. (1) Where a garage is built as part of a dwelling house or attached thereto—

Garage attached to dwelling house.

- (a) the underside of the floor of the room above the garage, shall be properly sealed with non-combustible material that has a fire resistance of at least thirty minutes;
- (b) the material covering the roof of the garage shall be as specified in Part IV;
- (c) the walls separating the garage from the remainder of the building, shall have a fire resistance of at least thirty minutes, be of non-combustible material and contain no combustible linings;
- (d) an opening in a garage wall shall—
  - (i) at its lowest point be at least 100mm above the level of the floor of the garage;
  - (ii) be protected by self-closing doors, having a fire resistance of thirty minutes; and
  - (iii) be arranged in a manner that access can be provided with lighting and ventilation for habitable room.

(2) A door for the purpose of sub-paragraph (1) (d) (ii) shall be deemed to be self-closing if it is hung on efficient rising butts, and shall be deemed to have the requisite fire resistance if constructed in accordance with the specification in KS 568 (Fire Resistance Tests – Door and Shutter Assemblies), for doors having a fire resistance of thirty minutes.

368. (1) Every external wall of a domestic or public building of one storey, not being a small house, shall, if the building has a capacity in column 1 of Table 54 set out in the First Schedule, and the distance of the wall from the nearest boundary corresponds with the distance specified in column 2, be constructed in accordance with the requirements for non-combustibility and fire resistance in column 3.

Modification of external wall of building.

(2) An external wall of a building whose occupancy is classified as F4 in Table 1 set out in the First Schedule, that is not intended to be used wholly or predominantly for storage, and that comprises of only one storey, shall be constructed in accordance with the requirements for non-combustibility and fire resistance specified as appropriate thereto in column 2 of Table 55 set out in the First Schedule.

(3) Where a building, other than a small house, is completely separated into at least two parts by a fire-division wall sub-paragraph (2) shall be deemed to be satisfied, if the external walls of each part, have the non-combustibility and degree of fire resistance appropriate in the case of an entire building of the same cubic capacity as that part of the building.

(4) Where an external wall of a domestic building of at least two storeys, other than a shop or small house, is a panel wall supported in a structural frame of metal or reinforced concrete and is constructed of

non-combustible material and is at least 3m or a distance equivalent to half the height of the building, whichever is greater, from the nearest boundary, or in the case of existing premises from those premises, the frame and panel of the wall, the wall shall have a fire resistance of one hour.

(5) An external wall of a building whose occupancy is classified as F4 in Table 1 set out in the First Schedule that is intended to be used wholly or predominantly for storage, shall, if the capacity of the building exceeds 7100m<sup>3</sup> or if its height exceeds 23m, be non-combustible throughout and have a fire resistance of four hours.

(6) Where a building is completely separated into at least two parts by a fire-division wall, paragraph 369 shall apply as if each the part were a separate building.

369. (1) This paragraph shall apply to walls separating houses or other buildings.

Separating wall.

(2) A wall shall be non-combustible.

(3) A wall shall, if constructed for the separation of residential buildings, have a fire resistance of four hours, and in case of other buildings, shall have a fire resistance of six hours.

(4) The construction of an opening in a wall shall be protected by a door or shutter that has a fire resistance of half the period required for that wall.

(5) Combustible material shall not be built into, carried through or over a wall, other than—

(a) the ends of wooden beams, joists or purlins which are protected by brickwork, or other solid and non-combustible material, that are at least 100 mm thick, or by a beam box of iron or other suitable non-combustible material; or

(b) a tiling or slating batten that is embedded in mortar or other suitable material.

(6) If the roof of a building separated by a wall, is not of solid slab or is of hollow slab construction of non-combustible material—

(a) the wall shall, if either of the buildings separated by it is a public building or a building whose occupancy is classified as F4 in Table 1 set out in the First Schedule, be carried up above the underside of the covering of the roof for a distance of at least 450mm (measured at right angles to the slope); and

(b) the wall shall, if the buildings are domestic buildings and either of them comprises more than five storeys, be carried up above the underside of the covering of the roof for a distance of at least 300mm (measured at right angles to the slope).

(7) In any case other than one to which sub-paragraph (6) applies, if the wall is not carried up above the underside of the covering of the

roof, the slates or other covering or slab shall be properly and solidly bedded in mortar on the top of the wall.

370. If a building being let in different tenancies, and the roof of the building is constructed of non-combustible materials, the internal walls shall be constructed in accordance with paragraph 368.

Buildings erected on single construction sites for different tenancies.  
Fire-division wall.

371. (1) A fire-division wall in a building shall be constructed in accordance with this Part.

(2) A building whose occupancy is classified as F4 in Table 1 set out in the First Schedule shall be divided internally with fire-division walls in a manner that ensures a floor area does not exceed 464m<sup>2</sup> and the capacity does not exceed 7100m<sup>3</sup>.

(3) The fire-division wall constructed in accordance with subparagraph (2) shall have a fire resistance of four hours, and in any other building, the fire division wall shall have a fire resistance of two hours.

(4) A building whose occupancy is classified as G1 in Table 1 set out in the First Schedule which extends to more than 930m<sup>2</sup> in area at any level of floor, shall be separated from all other parts of the building by a fire-division wall.

372. A wall constructed for the separation of flats within a building, other than a load-bearing wall, shall have a fire resistance of one hour if the building is a residential building intended to be used wholly or predominantly for habitation and exceeds either 15m in height or 233m<sup>2</sup> in floor area, on one storey and one hour in any other case.

Wall separating flats.

373. (1) In a building, other than a small house, which comprises of more than one storey, and if the building is of a class and description in columns 1 and 2 of Table 56 set out in the First Schedule—

Fire resistance of floor, column, beam or wall.

- (a) a storey above the lowest storey;
- (b) a load-bearing wall, other than an external wall, a separating wall or a fire-division wall;
- (c) a column and beam, other than one which is specifically exempt; and
- (d) a wall enclosing a common staircase or a lift well;

shall have the corresponding fire resistance specified in column 3.

(2) Where more than one period of fire resistance would be applicable, according to whether regard is had to the height, floor area or capacity of the building, the longest period shall be taken to be the required period of fire resistance.

(3) Where a building is completely separated into at least parts by fire-division walls, or comprises of at least two dwellings, shops or other premises (not being individual flats) this paragraph shall apply to each the parts, dwellings, shops or premises as if it were a separate building.

(4) An opening in an internal wall that encloses a common staircase or a lift well shall be protected by doors or shutters that have a fire resistance of not less than half the period required for that wall, and the doors or shutters shall have a fire resistance of at least thirty minutes.

374. A public building of an occupancy classified as A1, A2, A3, A4, C1 or C2, in Table 1 set out in the First Schedule shall have a ceiling which has a fire resistance of thirty minutes, and this paragraph shall apply in respect of any other public building on account of a fire hazard.

Ceiling of public building.

375. A building shall be constructed of non-combustible material that has the same fire resistance as that required for the walls of the building in which the staircase is provided where the building—

Staircases for separate dwellings.

- (a) comprises of at least two dwellings, a flight of a staircase and a landing forming part of a main staircase, intended for common use by the occupants of the dwellings; and
- (b) exceeds 15m in height or on one storey, or exceeds 232m<sup>2</sup> in floor area.

376. (1) In a cavity wall built wholly or partly of combustible material, the cavity between the leaves formed of, or containing combustible material, shall be fire-stopped at the junction of the wall with another wall or with any floor, ceiling or roof and, if the wall exceeds 4.5m in length, at intervals that do not exceed 4.5m.

Fire stop in cavity wall.

(2) A cavity wall may be fire-stopped by blocking the cavity with non-combustible material.

377. (1) An opening in an external wall, shall only be constructed where the wall is not within —

Opening in external wall.

- (a) 2.3m in a central area;
- (b) 1.5m in a residential area; and
- (c) 3m in any other area,

from a boundary, other than a wall abutting to a road.

(2) On a return wall, or one at right angles to the nearest boundary, the distance of the opening from the boundary, may be reduced to 800mm or if the separating wall projects 600mm beyond the face of the return wall, the distance from the boundary may be reduced to the thickness of the separating wall.

(3) In a building, other than a dwelling house that does not exceed two storeys, where a part of an opening in an external wall is vertically above an opening in an adjoining storey, a provision shall be made to prevent the spread of fire from the lower to the upper opening.

(4) Sub-paragraph (3) shall be considered satisfied if—

- (a) the bottom of the higher opening is at least 900mm above the top of the lower opening and is at least 600mm above the upper surface of the floor separating the storeys; or



- (b) a balcony constructed of non-combustible material with a solid floor or a similar horizontal projection is constructed between the two openings so as to project 600mm from the wall and extend laterally beyond each limit of the overlap of the openings in such a way that—
- (i) where the lower opening continues beyond that limit, it is at least 300mm; and
- (ii) where the upper opening continues beyond that limit, it is at least 600mm.

378. A part of a structural frame, beam or column that carries an external wall, a separating wall or a fire-division wall, shall have the same fire resistance as that of the wall it carries.

Structural member supporting wall.

379. Where the external walls of buildings on adjacent construction sites are contiguous with a common boundary, and the walls are panel walls supported in a structural frame of metal or reinforced concrete and otherwise fulfil the requirements of paragraph 368, the combined thickness of the panel walls shall provide the full fire resistance required.

External panel wall in framed structure.

380. A building which exceeds two storeys in height, and in which the floor of any upper storey is more than 6m above the surface of the road or ground on any side of the building, shall have an appropriate means of escape in case of fire.

Residential or public buildings

381. (1) Every fire escape from an upper storey, shall terminate at ground level at a point where the dispersal into a safe area can be quickly accomplished.

Access from fire escape.

(2) Where a safe area can be localized on an upper floor of a building, which is easily accessible for the purpose of rescue, the means of escape may terminate at this point, if the safe area is of no greater height than 6m above the adjoining ground level, and is railed off or otherwise fenced to provide adequate protection for the persons using it.

382. (1) Firefighting equipment shall be provided in every public building.

Firefighting equipment.

(2) The firefighting equipment referred to in sub-paragraph (1) shall include—

- (a) a hydrant, hose, hose reels and fire appliance fixed to an external connection;
- (b) a portable fire appliance;
- (c) a sprinkler, drencher and water spray projector system;
- (d) a water storage tank; and
- (e) a dry riser.

383. (1) A building shall be divided into separate but interconnected divisions comprising an area that does not exceed that specified in Table 57 set out in the First Schedule.

Division of building into components.

(2) Where an occupancy classified as J1 in Table 1 set out in the First Schedule, is used for the storage of flammable liquids and forms part of a building, the occupancy shall be a separate division and the area of the division shall not exceed 100m<sup>2</sup>.

(3) Where storage of goods is to a height of more than 3 m in any occupancy classified J1 or J2 in Table 1 set out in the First Schedule, a fixed installation for automatic fire extinguishing shall be provided.

384. (1) Where a component of a building is required to have a particular fire resistance, the requirement shall, in respect of the materials or method of construction be satisfied where—

Fire performance.

- (a) the materials or methods are in accordance with the particulars set out in Table 58, Table 59, Table 60, Table 61, Table 62 and Table 63 set out in the First Schedule;
- (b) a representative specimen of the element or component has been shown to have the required fire resistance when tested by the Kenya Bureau of Standards; or
- (c) an assessment, in writing, of the element or component has been made by the Kenya Bureau of Standards and the element or component has been found suitable for the particular purpose.

(2) Where the non-combustibility of an element or component is required under this Part, the requirement shall be satisfied where—

- (a) the element or component is proved to be made only of the approved material in accordance with Part V;
- (b) a representative specimen of the element or component has been shown to be non-combustible upon being tested by the Kenya Bureau of Standards; or
- (c) an assessment, in writing, of the element or component has been made by the Kenya Bureau of Standards, and the element or component has been found to be suitable for the particular intended purpose.

(3) In a building not being a building classified as H4 in Table 1 set out in the First Schedule, an architectural or decorative feature may be constructed of combustible material where the material has been the subject of an evaluation by the approving authority or in accordance with the Standards Act.

Cap. 496

385. (1) A portion of a building that has an occupancy, or a group of occupancies, specified in sub-paragraph (2) shall be separated by a separating wall constructed in accordance with paragraph 370, from a portion of the building used for an occupancy, or group of occupancies, specified in sub-paragraph (2)

Fire resistance of buildings of different occupancies.

(2) The occupancies referred to in sub-paragraph (1) are those classified as A1, A2, A3, A4, C1, C2, A5, B1, D1, B2, B3, D2, D3, D4, F1, F2, F3, G1, J2, J3, J4, E1, E2, E3, H2, H3 and J1 in Table 1 set out in the First Schedule.

(3) The separating wall referred to in sub-paragraph (1) shall have a fire resistance of at least that in column 2 of Table 64 set out in the First Schedule.

386. (1) A structural element or component thereof, that directly supports a separating wall referred to in paragraph 370, shall satisfy the requirement for stability for a period that is not shorter than that required for fire resistance of the separating wall, in accordance with KS 566 (Specification for fire resistance tests - elements of building construction).

Fire stability of structural element or component.

(2) A structural element or component thereof, not being a component that forms part of a roof assembly), which is located in an occupancy in the second column in Table 65 set out in the First Schedule, shall satisfy the requirement for stability for a period that is not shorter than that in the third, fourth, fifth, sixth and seventh columns of Table 65, for the height of the building specified therein, in accordance with KS 02-566 (Specification for Fire Resistance Tests - Elements of Building Construction).

(3) The structural elements or components thereof, used in a basement which is not naturally ventilated, shall be installed in accordance with the requirements in the seventh column of Table 65 set out in the Fifth Schedule.

(4) In this paragraph, a basement which is naturally ventilated shall be construed as being an additional storey to the building concerned, and a structural element or components thereof, used in the basement shall be in accordance with the requirements in the third, fourth, fifth and sixth columns, as the case may be, of Table 64 set out in the First Schedule.

(5) Unprotected steel shall not be used as part of the structure of a basement.

(6) A structural component may be made of—

- (a) unprotected steel—
  - (i) in a single-storey building;
  - (ii) in a two-storey building where the occupancy is classified as A3, A4, A5, B2, B3, C2, D2, D3, D4, G1, H4, J2, J3 or J4 in Table 1 set out in the First Schedule; or
  - (iii) in the topmost storey of a building where the floor of the topmost storey is a concrete slab, the building does not exceed 15m in height, and is of an occupancy classified as B3, D3, D4, G1, J3 or J4 in Table 1 set out in the First Schedule;
- (b) timber construction that is in accordance with KS EN 1995-1-2 (Design of timber structures - Part 1-2: General - Structural fire design), has a fire resistance of at least 30 minutes, and where the occupancy of the building is classified as G1, H3 or H4 in Table 1 set out in the First Schedule;

provided that the timber construction shall not exceed two storeys in height.

(7) A perforated floor type or mezzanine floor, that does not exceed 100m<sup>2</sup> in area shall not be considered to be a structural element or component thereof.

387. A separating wall constructed in accordance with paragraph 368, that is between tenancies where the occupancy is classified as H1, H2 or H3 as in Table 1 set out in the First Schedule, shall have a fire resistance of at least thirty minutes.

Tenancy  
separating wall.

388. (1) A partition wall in an occupancy classified as E1, E2 or E3 in Table 1 set out in the First Schedule, shall have a fire resistance of at least one hour and the partition wall in an occupancy classified as G1, H2, H3 or H4 in Table 1, shall have a fire resistance of at least twenty minutes.

Partition wall and  
other partition.

(2) In a building whose occupancy is classified as H3 or H4 in Table 1 set out in the First Schedule—

- (a) a wall between a garage and a habitable room shall have the same fire resistance as that specified for the internal walls of the building;
- (b) a door between a garage and a room shall be a solid timber or solid timber core door of at least 40mm in thickness; and
- (c) a roof space shall be divided by the vertical extension of the wall to the underside of the roof covering.

(3) A partition wall erected on a storey above the third storey of a building shall be non-combustible, or shall not increase a fire load by more than 5kg/m<sup>2</sup> of floor area in a division.

389. (1) Where an opening in an external wall of a division is less than 1m measured horizontally or vertically from an opening in another division, a 500mm projection from the wall shall be constructed between the openings and the projection shall have a fire resistance of not less than half that required for the element separating the divisions.

Protection of  
opening.

(2) Other means of fire protection besides the protection referred to in sub-paragraph (1), which ensures that a flame travel path from one opening to another does not exceed 1m may be used.

(3) Where there is an opening in a wall required to have a fire resistance of at least one hour, the opening shall have a fire door or fire shutter, of the class in the third column of Table 66 set out in the First Schedule.

(4) Sub-paragraph (3) shall not apply—

- (a) to an opening of the entrance to a lift;
- (b) where the opening, not being an opening referred to in sub-paragraph (1), gives access to a safe area outside the building; or

- (c) in the case of a service shaft that is fire stopped at every floor level.

(5) A fire door or fire shutter shall be installed in accordance with KS 02- 568:1985 (Fire resistance tests - Door and shutter assemblies), and shall be fitted with an approved self-closing or automatic closing device.

(6) A fire door which is required to have a specific fire resistance may be replaced by two separate fire doors which shall be positioned apart for at least one and a half times the width of a leaf of the door:

Provided that the sum of the fire resistance of the separate doors shall not be less than the fire resistance required for the first-mentioned door.

(7) Hinged fire doors installed in accordance with sub-paragraph (6) shall open in the same direction.

390. (1) Except where a building is classified as H3 or G1 in Table 1 set out in the First Schedule, which does not exceed two storeys in height, or where a building is classified as H4 in Table 1, a raised access floor, not being a mezzanine floor, shall not be constructed of combustible material unless the floor has ground directly below it, or does not exceed 50mm above a non-combustible slab.

Raised access and suspended floor for combustible material.

(2) The access floor referred to in sub-paragraph (1) shall be constructed—

- (a) if the void under a raised access floor is not connected to a space in another division unless the connecting opening is protected with a fire door, fire shutter or fire damper, that has the same fire resistance as the division separating wall;
- (b) if the void below a raised access floor is divided by fire stops into an area that does not exceed 300m<sup>2</sup> or is protected by a fixed automatic fire-fighting system; or
- (c) if the void is used as an artificial ventilation plenum in accordance with this paragraph.

391. (1) Where a roof of a part of a building meets a wall of a higher part of the building, and the wall has an opening in a position within 10m above, and 5m to either side of the roof, the roof shall, for a distance of at least 5m from the wall, have the fire resistance required for a separating wall for the occupancy in question.

Roof assembly and covering.

(2) Where a combustible roof covering material, including thatch, shingles and bituminized felt on boarding, is used and the plan area of the roof exceeds 20m<sup>2</sup>, the distance between the building covered and a boundary, shall be at least 4.5m.

(3) Where a roof covering includes individual small areas of combustible material, the total area of which does not exceed 5% of the roof area, and where the individual area does not exceed 20m<sup>2</sup>, the roof covering shall not be considered a combustible roof covering.

(4) Sub-paragraph (3) only applies where the slope of the roof—

- (a) does not exceed 60° and there is a distance of at least 1m between two of the small areas; and
- (b) is in excess of 60° and there is a minimum distance of at least 1m measured horizontally, and 3m measured along the slope of the roof between any two of the small areas.

(5) A combustible waterproof membrane in contact with a concrete slab shall, for the purposes of this paragraph, be considered non-combustible.

(6) Where a roof space is formed between a ceiling and a roof covering, the space shall be divided by means of non-combustible fire-stops into areas that do not exceed 300m<sup>2</sup> and the distance between the fire-stops shall not exceed 30m.

(7) Sub-paragraph (6) shall not apply where the roof space and the room below are protected by a fixed automatic fire-fighting system.

(8) The roof space referred to in sub-paragraph (6) that is used as an air-conditioning or artificial ventilation system plenum shall be constructed in accordance with sub-paragraph (5).

(9) In the case of an occupancy classified as H3 in Table 1 set out in the First Schedule, the walls separating dwelling units shall be extended and the extensions shall—

- (a) have the same fire resistance as the wall supporting it;
- (b) be constructed in a such a manner that the underside of a non-combustible roof, roof covering or concrete slab below a combustible roof covering, as the case may be; and
- (c) be constructed in such a manner that at least 300mm above a combustible roof covering other than one laid on concrete.

392. (1) For a building, not being a building classified as H4 in Table 1 set out in the First Schedule, combustible material shall not be used for a suspended ceiling except—

Ceiling.

- (a) if it is solid timber; or
- (b) if the air supply or return air intake grilles are made of combustible material where the sum of the area of all the grilles forms not more than 5% of the total area of the ceiling and the overall area of an individual grille does not exceed 0.09m<sup>2</sup>.

(2) Where combustible material is used in a suspended ceiling in a building, the maximum area of any division in which the ceiling is situated shall not exceed a quarter of the relevant division area in Table 57 set out in the First Schedule for the relevant occupancy classification.

(3) Sub-paragraph (2) shall not apply where a building—

- (a) does not exceed three storeys in height; or

(b) is provided with a fixed automatic fire-fighting system.

(4) Where the space between a suspended ceiling and a structural floor above the ceiling is used as a plenum for an air-conditioning or artificial ventilation system, the space shall be divided by non-combustible fire-stops into areas that do not exceed 300m<sup>2</sup> and the distance between the fire-stops shall does not exceed 30m:

(5) Sub-paragraph (4) shall not apply where the space and the room below it is protected by a fixed automatic fire-fighting system.

(6) If a roof has a ceiling, it shall have a door or scuttle to allow access to the roof space.

393. (1) Where a combustible material, not being a material not contemplated in this paragraph to be used as a floor covering in a building is used, the maximum area of a division in which the floor covering is used shall not exceed one quarter of the relevant division area in Table 67 set out in the First Schedule for the relevant occupancy classification.

Floor covering.

(2) Sub-paragraph (1) shall not apply where a building—

- (a) does not exceed three storeys in height; or
- (b) is provided with a fixed automatic fire-fighting system.

(3) A fitted carpet may be installed in a building, where the carpet is of a type of which a representative specimen and has the classification in Table 67 set out in the First Schedule for the particular occupancy concerned when tested in accordance with—

- (a) KS 561 (Fire tests on building materials - Part 1: Non-combustibility test);
- (b) BS 476-4 (Fire Tests on Building Materials and Structures, Non-Combustibility Test for Materials);
- (c) BS 4790 (Method for Determination of the Effects of a Small Source of Ignition on Textile Floor Coverings, Hot Metal Nut Method); or
- (d) ISO 6925 (Textile floor coverings - Burning behaviour - Tablet test at ambient temperature).

(4) Sub-paragraph (3) shall not apply where a fitted carpet is laid in an occupancy classified as H4 in Table 1 set out in the First Schedule.

(5) In a building, a cork, timber or any resilient floor covering may be installed where the covering is fully adhered to the substrate.

394. (1) Where, in a building, combustible material not being a material contemplated in this paragraph, is used as a finish on a wall the maximum area of the division in which the wall is situated shall not exceed one quarter of the relevant division area in Table 68 set out in the First Schedule.

Wall finish.

(2) Sub-paragraph (1) shall not apply where the building—

- (a) does not exceed three storeys in height; or
- (b) is provided with a fixed automatic fire-fighting system.

(3) A combustible wall lining or decorative finish, except where used in a building classified as H4 in Table 1 set out in the First Schedule, shall be of a type of which a representative specimen, when tested in accordance with KS 566 (Specification for fire resistance tests - elements of building construction) has a classification not inferior to that in Table 68 set out in the First Schedule for the occupancy concerned.

(4) Sub-paragraph (3) shall not apply where the thickness of the finish is less than 0.5mm and the finish adheres fully to a non-combustible material.

(5) Combustible material may be used for a door leaf, or for a trim to a door frame or window frame, or for a pelmet, dado rail, picture rail or skirting.

395. (1) A building shall be provided with at least one escape route that can be used in case of a fire or another emergency.

Provision of  
escape route.

(2) An escape route shall not, at any time, be obstructed in any way.

(3) Where the travel distance, measured to the nearest escape door, does not exceed 30m, the escape route shall not be required to include any emergency route—

- (a) in single-storey building;
- (b) in a dwelling unit having the escape door at ground level; or
- (c) in and from a dwelling unit at first floor level where the dwelling unit is served by an individual staircase to ground level.

(4) A building of two storeys in height shall not be required to include any emergency route.

(5) Where the population of the upper storey of a two-storey building exceeds twenty-five persons, the building shall have at least two escape routes.

(6) A building of a height that exceeds three storeys shall have at least two escape routes and—

- (a) an emergency route shall form part of each of the escape route; or
- (b) an emergency route shall include a staircase that forms part of the escape route and also that part of the escape route from the lower end of the staircase to an escape door.

(7) Where, in a building, the travel distance measured to the nearest escape door exceeds 30m, at least two escape routes shall be provided and an emergency route shall form part of each of the escape routes.



- (8) Where emergency routes are required in a building—
- (a) the emergency routes shall be entirely independent from one another and situated in such a manner that, should any one of the routes become unusable or inaccessible, not less than one other route shall remain accessible and usable;
  - (b) the travel distance measured to the nearest access door shall not exceed 30m;
  - (c) the path of travel to an access door shall be along a feeder route;
  - (d) the feeder route shall enable a person to exit in two different directions to at least two independent emergency routes; and
  - (e) the exit door from a room shall lead directly into a feeder route.

(9) An exit door may enable a person to exit into a dead-end corridor where the total distance to be travelled from the farthest point in the room to an access door, or to a feeder route does not exceed 15m, or the exit door may enable a person to exit into another room, where the other room is within the same tenancy and the exit door from the other room leads into a feeder route.

(10) In a mixed-use building, separate means of escape shall be provided from a storey, or parts of a storey, used for residential or assembly and recreation purpose.

(11) When an escape staircase forms part of the only escape route from an upper storey of the building, it shall not be continued down to serve a basement.

(12) The basement referred to in sub-paragraph (11) shall be served by a different staircase.

396. (1) Where the population of a room does not exceed twenty-five persons, the width of any exit door shall be at least 900mm. Exit door.

(2) A room which has the capacity to accommodate the number of persons in the first column of Table 69 set out in the First Schedule, shall have the number of exit doors in the second column thereof and shall—

- (a) open in the direction of travel along the escape route; and
- (b) have an aggregate width of not less than the required width for an escape route for the population, as contemplated in this paragraph.

(3) In a room in a building where the occupancy is classified as A1, A2, A3, A4, C1, C2, E2, E3, F1 or F3 in Table 1 set out in the First Schedule, an exit door shall open in the direction of travel along the escape route.

(4) In an occupancy classified as A3 in Table 1 set out in the First Schedule, where the population of the room is less than fifty persons, an exit door may open into the room.

(5) A panic latch or electronic switch shall be provided, as may be necessary, for opening an exit door.

397. (1) Where a corridor in a building forms part of a feeder route, the walls, partition walls or partitions enclosing the corridor, shall be constructed of non-combustible material, or a material which, when tested in accordance with BS 476-22 (Fire Tests on Building Materials and Structures, Non-Combustibility Test for Materials), shall have a surface fire index that does not exceed 2.0. Feeder route.

(2) A door in the path of travel along a feeder route shall be of the double swing type, and the door shall not be lockable.

(3) Where, for security reasons, it is necessary to lock the door referred to in sub-paragraph (2), an approved alternative means of escape shall be provided.

398. (1) A wall enclosing an emergency route shall have a fire resistance of at least two hours, or the relevant time required for stability of a structural element or a component thereof as specified in Table 65 set out in the First Schedule, whichever is less, after being subjected to two impacts of a 30kg mass sand-bag swung from a vertical height of 1.5 m. Emergency route.

(2) A floor or ceiling of an emergency route shall have a fire resistance of at least two hours, or the relevant time required for the stability of a structural element or a component thereof as specified in Table 65 set out in the First Schedule, whichever is less.

(3) The finish of the floor of an escape route shall have a slip resistant surface, and shall be free from a projection, indentation, hollow or covering, which may cause a person to trip, and the finish, or a covering applied to the floor shall be of a classification that is not inferior to that in Table 67 set out in the First Schedule.

(4) An emergency route shall consist of at least one of the following components that are arranged in such a manner that each of the component discharges directly to another component—

- (a) a door;
- (b) an internal or external passage;
- (c) an internal or external staircase or ramp; and
- (d) a lobby, foyer or vestibule.

(5) The last component of an emergency route shall discharge at ground level directly to a road, public place or an approved open-air space leading to a road or public place.

(6) An access door or another door, being a component of an emergency route shall be a hinged door which shall open in the direction of egress from the building.

(7) A revolving door, sliding door or an automatically operated door, or shutter, may form part of an emergency route where the door or shutter is positioned at the end of the route discharging to a safe area:

Provided that—

- (a) there is, adjacent to the door or shutter, an alternative hinged door which is installed in accordance with this Part; or
- (b) an automatically operated sliding door or shutter, which is equipped with an approved fail-safe system and the revolving door is an approved collapsible type.

(8) A door giving access to an emergency route shall be installed in such a manner that, when opened, it does not obstruct the progress of a person using the route.

(9) A door frame, or a door leaf when in the open position, shall not protrude into the width of the emergency route by more than 100mm on either side.

(10) An unlocking device shall be fitted to an access door or escape door in an emergency route.

(11) A door fitted with an unlocking device shall be clearly indicated on the fire plan.

399. (1) The width of an escape route within a room having a population that exceeds twenty-five persons shall be at least 900mm.

Dimensions of  
escape route.

(2) The width of an escape route or a component thereof, between an exit door and the end of the route shall be at least 1.1m.

(3) The width of an escape route shall not decrease in the direction of emergency travel, provided that in the case of a lobby, foyer or vestibule, that is wider than that required for the route, the exit door therefrom shall have a width that is not less than that required for the route.

(4) The travel distance shall be measured along the centre line of the shortest natural unobstructed path of travel within a room and along an escape route, and where the route is via a ramp or staircase the measurement shall be along the plan centre line of the ramp or staircase.

(5) An escape route shall be provided throughout its length with a clear vertical headroom of 2m and in a lobby, foyer or vestibule, the room height shall be at least 2.4 m.

(6) The population of a room, storey or portion thereof, shall be the actual number of persons in the room, storey or portion thereof, during normal use or shall be calculated from the criteria specified in this paragraph.

(7) Where more than one escape route discharges to a common component, the width of the common component and a following component situated along the direction of egress shall be calculated by taking into account the population discharging into the common component.

(8) In the case of a staircase, only the population of the most heavily populated storey served thereby shall be deemed to discharge into the staircase.

(9) In a building, the width of an escape route to be provided in respect of a room, storey or portion thereof, shall be not less than that in Table 70 set out in the First Schedule for the population concerned:

Provided that—

- (a) an individual escape route shall not be designed for a population that exceeds two hundred persons; and
- (b) where there are at least two emergency routes, one of the routes shall be discounted in determining the widths required for the other route.

(10) The aggregate width of escape routes shall be so distributed that the minimum width of an individual route serving a room, storey or portion thereof, shall be as nearly equal to the other route, another room, storey or portion thereof, as is practicable.

400. (1) In a building that is not classified as D4 or H4 in Table 1 set out in the First Schedule, a basement storey shall be served by at least two separate emergency route staircases.

Basement.

(2) Where a basement storey is used for parking motor vehicles, one of the emergency route staircases referred to in sub-paragraph (1) may be replaced by a motor vehicle ramp.

401. (1) The storey of a duplex dwelling unit may be served by a single staircase within the dwelling unit:

Change in levels along escape route.

Provided that the dwelling unit shall have access to an escape route as required in this Part.

(2) At a storey level, the entrance to a staircase that forms part of an emergency route shall be at least 5m from the entrance to any other staircase.

(3) A staircase that forms part of an emergency route shall discharge into a corridor or foyer, that forms part of the emergency route, or into a road, public place or approved open space.

(4) A staircase that forms part of an emergency route from a storey above ground level shall not have direct access to a basement storey.

(5) An escalator shall not form a component of an emergency route.

(6) Where a staircase forms part of an emergency route, the staircase shall, throughout its length, have a handrail on each side.

(7) Despite the requirements for minimum width specified in sub-paragraph (2), the width of a staircase that forms part of an emergency route shall not be less than that in Table 70 set out in the First Schedule for the population concerned, and the width shall not exceed 1.9m:

Provided that a handrail may project into the width of the staircase but not by more than 100mm.

(8) The distance between a change in floor level and the centre line of a doorway in an emergency route, or between two changes of floor level in the route, shall be at least 1.5m.

(9) A curved or winding staircase shall not form part of an emergency route.

(10) The rise and tread of a step that forms part of an emergency route shall be installed in accordance with this paragraph, and the step shall have a solid tread and riser.

(11) In an occupancy classified as D4 in Table 1 set out in the First Schedule, or in the case of an external staircase, the risers may be omitted.

(12) A change in the level of the floor of an emergency route other than by a staircase between levels, shall be by means of a ramp or a staircase:

Provided that—

- (a) the ramp shall not have a slope that exceeds 1 in 8; and
- (b) the staircase has at least three stairs.

402. An enclosed staircase which is a component of an emergency route in a building that does not exceed 30m in height shall be—

Ventilation of staircase in emergency route.

- (a) provided with a window, or another opening that is at least 1m<sup>2</sup> in area for ventilation to the outside of the building at each storey level; or
- (b) ventilated by means of a roof ventilator that has an effective area of at least 25% of the plan area of the stairwell and the ventilator shall be permanently open.

403. (1) In a building, not being a building classified as H4 in Table 1 set out in the First Schedule, an opening, including an opening occupied by a staircase or escalator that does not form part of an escape route, shall not connect more than—

Opening in floor.

- (a) two storeys, if the building is not protected by a sprinkler system; or
- (b) four storeys, if the building is protected by a sprinkler system.

(2) At a landing of the staircase or escalator system, a sign shall be displayed indicating the direction of at least one of the escape routes.

404. (1) An external staircase shall not be a component of an emergency route of a building which exceeds 18m in height, unless the staircase is partially enclosed through its length.

External staircase in passage.

(2) A window, door or other unprotected opening in any facade of a building, shall be at least 3m from an access door or an open staircase that forms part of an escape route, unless the opening is protected by a door or fire shutter that has a stability rating of thirty

minutes when tested in accordance with KS 568 (Fire resistance tests - Door and shutter assemblies).

(3) Sub-paragraph (2) shall not apply to a window that does not exceed 0.3m<sup>2</sup> in area and serves a room containing a water closet pan or a bathroom, cloakroom or kitchen.

405. (1) Where a lobby, foyer or vestibule, is a component of at least one escape route, it shall have the combined width of all escape routes discharging into it or be 33% wider than the width calculated on the basis of the population which is to pass through it, whichever is greater.

Lobby, foyer or vestibule.

(2) A display in a lobby, foyer or vestibule, shall be a fixed board or fixed display case, which does not protrude for more than 150mm into the lobby, foyer or vestibule, and no other object shall be placed in the lobby, foyer or vestibule.

(3) Glass used for a display case in a lobby, foyer or vestibule, shall be safety glass.

406. (1) A building that has emergency routes shall be clearly marked and signposted to indicate the direction to be travelled in the case of an emergency in the approved size and position.

Marking or sign posting.

(2) The exit door of a room which has a population that does not exceed twenty-five persons may not be marked in accordance with sub-paragraph (1).

(3) Where a room has more than one exit door, the door used for normal egress from the room shall not be required to be marked in accordance with sub-paragraph (1).

(4) In the case of an auditorium or hall, a sign reading "EXIT" and "KUTOKA" shall be displayed over an exit door of the auditorium or hall, and the sign shall have letters of at least 150mm in height.

(5) Where a building is occupied, a mark or sign installed in accordance with sub-paragraph (1) shall be illuminated to an intensity of at least 50lux.

(6) In an occupancy classified as A2, E1, E2, E3 in Table 1 set out in the First Schedule, or in a building that is usually occupied during the hours of darkness and that has a population that exceeds 100 persons, a mark or sign installed in accordance with sub-paragraph (1) shall, in the event of the failure of the normal mains supply, be illuminated for at least two hours.

(7) The emergency power supply to the lighting of a marks or sign installed in accordance with sub-paragraph (1) shall be protected against the effects of fire for a period of at least two hours.

(8) For the safety of the occupants of a building, an owner shall provide a sign prohibiting exit of a building.

407. (1) An emergency route shall have artificial lighting and, when the building containing the route is occupied, there shall be an illuminance of at least 50 lux on a horizontal plane 100mm above the floor.

Lighting of feeder or emergency route.

(2) In a building that has a population that exceeds one hundred persons, at least one emergency light source shall be installed in the emergency route and the light source shall be connected to an approved emergency power supply which is—

- (a) independent of the main electricity supply; and
- (b) in the event of a failure of the lighting, provides power supply to the emergency light source for at least one hour.

(3) An emergency light source shall be located in such a manner that—

- (a) the horizontal illuminance at the centre line of the emergency route is at least 0.3lux; and
- (b) a uniformity ratio that does not exceed 40:1 is obtained along the emergency route.

(4) A feeder route in a basement storey or in any building classified as A1, A2, A3, A4, C1, C2, E2, E3, F1, F3 or H2 specified in Table 1 set out in the First Schedule, shall have emergency lighting as referred to in sub-paragraph (2).

(5) In an occupancy classified as A3 specified in Table 1 set out in the First Schedule, that has a population of less than fifty persons and a feeder route in a basement storey may not have emergency lighting as referred to in sub-paragraph (2).

408. (1) A building containing an occupancy classified as E2, E3, F1, H1 or H2 specified in Table 1 set out in the First Schedule, shall have a fire detection system.

Fire detection and alarm system.

(2) An occupied area within a building which exceeds 30m in height, or contains a storey exceeding 5,000m<sup>2</sup> in floor area, other than a building referred to in sub-paragraph (1), shall have a fire detection system, a manually activated fire alarm system and an emergency evacuation communication system.

(3) A building classified as A1, A2, C1, C2 or F1 specified in Table 1 set out in the First Schedule, shall have a manually activated audible alarm system.

(4) A building except that classified as H3 and H4 in Table 1 set out in the First Schedule, shall install an alarm system that warns a person who has a hearing impairment.

409. (1) Fire-fighting equipment in a building shall be installed in such a manner that it is ready for use at all times and that access to the fire-fighting equipment is not obstructed by any object.

Provision of fire-fighting equipment.

(2) The position of fire-fighting equipment shall be clearly visible, and shall be indicated by signs which are placed in the approved manner.

(3) The owner of a building shall keep available for inspection, a record of the maintenance of fire-fighting protection equipment.

410. (1) A design of a fire installation shall provide for water to be supplied in the quantity and at the pressure and rate of flow in accordance with—

Water reticulation for fire-fighting purposes.

- (a) BS 5306-0 (Fire protection installations and equipment on premises - Part 0: Guide for selection, use and application of fixed firefighting systems and other types of fire equipment);
- (b) BS 5306-1 (Code of practice for fire extinguishing installations and equipment on premises - Part 1: Hose reels and foam inlets);
- (c) BS 5306-2 (Fire extinguishing installations and equipment on premises - Part 2: Specification for sprinkler systems);
- (d) BS 5306-3 (Fire extinguishing installations and equipment on premises - Part 3: Commissioning and maintenance of portable fire extinguishers - Code of practice);
- (e) BS 5306-4 (Fire protection installations and equipment on premises - Part 4: Specification for carbon dioxide systems);
- (f) BS 5306-5 (Fire protection installations and equipment on premises - Part 5: Halon Systems);
- (g) BS 5306-6 (Fire protection installations and equipment on premises - Part 6: Foam systems);
- (h) BS 5306-7 (Fire protection installations and equipment on premises - Part 7: Powder systems);
- (i) BS 5306-8 (Fire protection installations and equipment on premises - Part 8: Selection and positioning of portable fire extinguishers - Code of practice);
- (j) BS 5306-9 (Fire protection installations and equipment on premises - Part 9 - Recharging of portable fire extinguishers - Code of practice); and
- (k) BS 5306-10 (Fire protection installations and equipment on premises - Part 10: Colour coding to indicate the extinguishing medium contained in portable fire extinguishers - Code of practice).

(2) Where the fire installation is not the subject of a design it shall be installed in accordance with paragraph 411.

411. (1) A hose reel used for firefighting shall be installed in a building of at least two storeys in height, or in any single-storey building that exceeds 250m<sup>2</sup> in floor area, at a rate of 1 hose reel for every 500m<sup>2</sup> or part thereof of floor area of a storey.

Hose reel.

(2) Sub-paragraph (1) not apply to a building classified as H4 in Table 1 set out in the First Schedule, or to a dwelling unit provided with independent access to ground level.

(3) A hose reel shall be installed in the building in accordance with KS 2003 (Hose-reel for firefighting (for fixed installations) – Specification).



(4) A hose reel shall be positioned in a manner that ensures that the end of the hose reaches any point in the area to be protected.

(5) A hose reel installed in a building shall bear, in a prominent position on the reel disc facing the user, the mark of standardization required under the Standards Act.

Cap. 496

(6) Where a satisfactory water supply and pressure are not available, two fire extinguishers that are made in accordance with paragraph 414.

412. (1) A hydrant shall be installed in an approved position.

Hydrant.

(2) A hydrant shall be installed in a building which has an occupancy classified as B1, B2, C1, C2, D1, D2, E1, E2, E3, F1, F3, H1, J1, J2, J3 or J4 in Table 1 set out in the First Schedule, exceeds 12m in height and has a total floor area that exceeds 1000m<sup>2</sup>.

(3) A hydrant shall be provided at the rate of at least one per 1000m<sup>2</sup> or part thereof of total floor area, at least one per storey of the building, and shall be distributed in a manner that ensures the fire hose reaches every part of the area.

(4) A hydrant shall have a length of 24m, or 30m in length together with couplings, and a 16mm internal diameter nozzle, and shall be in accordance with BS 5041: Part 1 (Fire Hydrant Systems Equipment, Specifications for Landing Valves for Wet Risers).

(5) The hose and nozzle referred to in sub-paragraph (4) shall, when positioned in the open air, or in a factory building be suitably housed in a cupboard.

(6) Sub-paragraph (5) shall not apply to an occupancy classified as J4 in Table 1 set out in the First Schedule.

(7) A ground or raised hydrant in a permanent amusement park or exhibition ground, shopping centre or group housing, cluster housing, or town house complex, shall be installed in such a manner that ensures that no point of the amusement park or exhibition ground, shopping centre or group housing, cluster housing, or town house complex, is farther than 90m from any hydrant.

(8) A hydrant shall be installed in accordance with BS 5041 (Fire Hydrant Systems Equipment).

(9) A hydrant shall not be used for any purpose other than firefighting.

(10) A person shall not operate, or attempt to operate a fire hydrant without the authorisation of the relevant county government.

(11) The construction of a new building or the repair of an existing building, shall not interfere with an existing fire hydrant.

(12) Where the gradient of an existing road or construction site changes, at the request of an owner, such that an existing public fire hydrant is not at the proper elevation with respect to the ground, the hydrant shall be raised or lowered at the expense of the owner.

(13) Clearance of any vegetation around a hydrant shall be maintained to ensure easy connection of a hose and full circle operation of the hydrant using a regular hydrant wrench or hose spanner.

(14) A shrub, tree, flower or weed, shall not be planted or permitted to grow, in a manner that prevents access to a fire hydrant from the road.

(15) The relevant county government shall maintain a reservoir of at least 100,00l within a radius of 5km from a hydrant.

(16) A fire hydrant shall only be painted by the relevant county government.

(17) A hydrant bonnet shall be colour coded in accordance with in Table 71 set out in the First Schedule for the amount of water that can be discharged out of them.

(18) The relevant county government shall place a red band on a hydrant to show that the hydrant is out of service.

413. (1) A sprinkler system shall be installed—

Sprinkler system.

- (a) in a building that exceeds 30m in height;
- (b) in a basement storey which exceeds 500m<sup>2</sup> in floor area and the storey is not naturally ventilated;
- (c) in a storey which exceeds 500m<sup>2</sup> in total floor area and the storey is not provided with a breakable or openable panel that is suitable for smoke-ventilation; and
- (d) in a common area in accordance with BS 9999 (Code of Practice for Fire Safety Design, Management and Use of Buildings).

(2) A fixed means of automatic fire extinguishing may be substituted for an approved sprinkler system under this paragraph.

(3) A sprinkler system may not be provided in a strong room, record room or security vault.

(4) A concealed space, not being a roof space, which has a clear height that exceeds 800mm, and a compartment that has a total area that exceeds 100m<sup>2</sup> above a ceiling, or a compartment that has a total area that exceeds 300m<sup>2</sup> below a raised floor, shall have a sprinkler system.

(5) A sprinkler system shall be fitted with a twin coupling for the attachment of a fire-pump in accordance with KS ISO 6182 (Fire Protection – Automatic Sprinklers Systems).

Provided that—

- (a) the coupling shall be painted lime yellow;
- (b) the pressure exerted by the pump shall not exceed 1000N/m<sup>2</sup>; and
- (c) the pressure limitation shall be clearly marked on the coupling.

414. (1) A building that contains an occupancy in the first column of Table 72 set out in the First Schedule shall, for the relevant occupancy and floor area, have the number of portable fire extinguishers specified in the corresponding second column thereof, in approved positions.

Portable fire extinguisher.

(2) The type of portable fire extinguisher to be provided and the number of fire extinguishers to be installed, may exceed the number in Table 72 set out in the First Schedule, if a particular hazard warrants the increase.

(3) An approved portable fire extinguisher installed in a building shall be in accordance with—

- (a) KS ISO/TS11602-1 (Fire protection - Portable and wheeled fire extinguishers - Part 1: Selection and installation);
- (b) KS ISO/TSO11602-2 (Fire Protection – Portable and wheeled fire extinguishers - Part 2: Inspection and maintenance); and
- (c) KS ISO 11602 (Fire Protection - Portable and Wheeled Fire Extinguishers).

(4) A portable fire extinguisher shall bear the mark of standardization that indicates that it has been evaluated by and is acceptable in accordance with the Standards Act.

Cap. 496

(5) The type of fire extinguisher shall, for the occupancy in which it is installed, have a capacity or mass rating as follows—

- (a) for an occupancy classified as A1, A2, A3, A4, A5, E1, E2, E3, F1, F2, F3, G1, H1, H2 or H3 in Table 1 set out in the First Schedule—
  - (i) a water type, of at least 9litres;
  - (ii) a foam type, of at least 9litres;
  - (iii) a carbon dioxide type, of at least 4.5kg;
  - (iv) a dry chemical type, of at least 9kg; and
  - (v) an inergen or argonite type; and
- (b) for an occupancy classified as B1, B2, B3, C1, C2, D1, D2, D3, D4, J1, J2, J3 or J4 in Table 1 set out in the First Schedule—
  - (i) a water type, of at least 9litres;
  - (ii) a foam type, of at least 9litres;
  - (iii) a carbon dioxide type of at least 5kg;
  - (iv) a dry chemical type of at least 9kg; and
  - (v) an inergen or argonite type.

415. (1) A fire extinguisher exceeding the capacities prescribed in the relevant specification developed under the Standards Act and

Mobile fire extinguisher.

fitted with wheels for transportation shall be deemed to be a mobile fire extinguisher.

(2) The number of mobile fire extinguishers which may be used in place of portable fire extinguishers, shall be half of the number of portable fire extinguishers required under paragraph 414 if—

- (a) the capacity of the mobile fire extinguishers is at least equal to the combined capacity of the portable fire extinguishers it is proposed to replace;
- (b) it contains the same extinguishing medium as required for the portable extinguisher;
- (c) it is used in place of a portable extinguisher only on the floor and within the division concerned;
- (d) the floor area to be served by it does not exceed 500% of that in Table 72 set out in the First Schedule or 1000m<sup>2</sup> on a single level, whichever is less;
- (e) the extinguishing medium is in accordance with the appropriate requirements under the Standards Act; and
- (f) it is kept in a readily accessible position.

Cap. 496.

416. Where in a building there is an inaccessible concealed space with a dimension that exceeds 5m the space shall—

Fire stopping of inaccessible concealed space.

- (a) be fire stopped, whether it contains combustible material or not;
- (b) where it is within a non-combustible building element, be fire stopped at least at every 5m measured horizontally or vertically, unless the space is a cavity of a masonry cavity wall; and
- (c) where it is within a combustible building element, be fire stopped at least at every 3m measured in both directions.

417. (1) The walls of an internal service shaft shall have a fire resistance that is not less than the requirements for structural stability in Table 65 set out in the First Schedule subject to a maximum requirement of two hours.

Protection in service shaft.

(2) Where a vertical service shaft is provided in a building and the shaft does not contain combustible material, it shall be fire stopped at the level of every fifth storey above the bottom of the shaft.

(3) Where a shaft is provided in accordance with sub-paragraph (2) and it contains combustible material, it shall be fire stopped at the level of every storey above the bottom of the shaft.

(4) Where a vertical service shaft is used for ventilation, or it contains non-combustible plumbing or drainage services, or is a non-combustible rubbish chute, a fire stop shall not be required within the shaft.

(5) Where a horizontal service shaft passes through a separating wall referred to in paragraph 368, and the wall has a fire resistance, the shaft shall be fire stopped where it passes through the wall.

(6) Where a service penetrates a separating wall referred to in sub-paragraph (5), the wall shall be completely sealed around the service.

418. (1) A service pipe, conduit, duct, sleeve, cable or other equipment recessed into a structural element or separating wall referred to in paragraph 395, which has a fire resistance, shall be set into the element or the wall, in such a manner that the fire resistance is not reduced to below the required fire resistance.

Building services  
in structural or  
separating  
element.

(2) A service pipe, conduit, duct, sleeve, cable or other equipment that penetrates through a wall or floor, where the wall or floor has a fire resistance shall be sealed in such a manner that the fire shall not penetrate the wall or floor.

419. (1) A room whose floor area exceeds 500m<sup>2</sup> shall have —

Smoke control.

- (a) a system of mechanical smoke ventilation; or
- (b) a roof ventilator, or a window or a panel, which when opened, allows smoke ventilation, and the roof ventilator, window or panel, shall—
  - (i) have an aggregate area of at least 3% of the floor area of the room or, in the case of a single-storey building where the room has an occupancy classified as D2 or D3 in Table 1 set out in the First Schedule, at least 1.5% of the floor area of the room;
  - (ii) be located in the roof, or in the upper third of the walls, as the case may be, and be distributed in such a manner that smoke is evenly extracted from all parts of the room; and
  - (iii) be designed in such a manner that the roof ventilator, window or panel opens automatically when activated by a heat or smoke detector, or if not, be manually operated, without the use of special tools, from the floor of the room.

(2) Where a room is situated in a place that a roof space or an external wall of the building, do not form part of the room, the room shall be equipped with a system of mechanical smoke ventilation.

(3) Where an openable panel is provided on a building elevation for the purpose of smoke ventilation, the position of the panel shall be marked on the outside of the building to enable easy identification by a firefighter.

420. A building shall be constructed in accordance with the provisions of this Part for effective division into compartments.

Division into  
compartments.

421. (1) An air-conditioning system or artificial ventilation system in a building shall be designed in a manner that prevents the

Air-conditioning  
and ventilation.

distribution of products of combustion in the event of a fire in the building. system.

(2) An air shaft or duct that is used for air-conditioning or artificial ventilation, including an internal or external insulation thereof, and any flexible joint, shall be constructed of non-combustible material or material approved by the Kenya Bureau of Standards:

Provided that—

- (a) an approved combustible flexible connection may be used where the length of the connection does not exceed 1.5m and the connection does not pass through a wall or floor which has a specified fire resistance;
- (b) an approved combustible flexible joint that does not exceed 250mm in length may be used in a plant room where the plant room is protected by a smoke detection system.

(3) A fire damper that is in accordance with EN 1751 (Vertical Ion of Buildings, Air Terminal Devices, Aerodynamic Testing of Damper and Valves) shall be provided in an air duct where the duct passes through a required separating wall referred to in paragraph 368, for a division or occupancy, or an element required for the enclosure of an emergency route, or passes into a duct.

(4) The fire damper referred in sub-paragraph (3) shall—

- (a) close automatically upon the operation of a suitably located sensing device actuated by an abnormal rise in the temperature or by the presence of smoke or combustion gases in the air duct;
- (b) have access at the position which is clearly marked, for inspection, maintenance and resetting of the mechanism;
- (c) be installed in such a manner that it remains in that position at the protected opening even if the air duct distorts during a fire; and
- (d) have an overriding fusible link.

(5) A plenum, excluding a return air intake, that forms part of an air-conditioning or artificial ventilation system, shall be constructed of non-combustible material or of a material which has been approved by an engineer as being suitable for the construction:

Provided that where the sum of the areas of all air supply and return air intake grilles in the plenum does not exceed 5% of the area of surface of the plenum exposed to the room below and no individual grille has an overall area that exceeds 0.09m<sup>2</sup>, the grille may be of combustible material.

(7) The support of a plenum shall be non-combustible.

(8) In a plenum system, the fire stops installed in accordance with paragraphs 392 (3) and 393 (4), shall be constructed of steel baffle plates which shall close automatically upon the operation of approved

sensing devices actuated when the temperature of the air in the space reaches 15°C above its design temperature or 45°C, whichever is lesser.

(9) A plenum system shall not be used for storing material or for accommodating people.

422. Where a flammable substance is stored, handled or used, there shall be prominently displayed in suitable positions in a division, occupancy, room or another part of a building, and on the outside of a door leading thereto a sign in English and Kiswahili of at least 25mm in height that reads “NO SMOKING” and “USIVUTE SIGARA”.

No smoking sign.

423. (1) In a building that exceeds 10m in height, a lift or bank of lifts, shall have a lift lobby at every level of discharge which shall not be made of combustible material.

Lift well.

(2) The lobby referred to in sub-paragraph (1) shall be divided from the remainder of the floor area by means of a wall which has a fire resistance of at least thirty minutes, and a door in the walls shall be an automatic or self-closing type, shall have all edges fitted with flexible seals to prevent the passage of smoke and air when closed, and shall—

(a) be designed in accordance with BS 7255 (Code of Practice for Safe Working on Lifts) and—

- (i) KS 2169-1 (Safety rules for the construction and installation of lifts - Part 1: Electric lifts);
- (ii) KS ISO 4190-2 (Lift (US: Elevator) installation - Part 2: Class IV lifts);
- (iii) KS ISO 4190-3 (Passenger lifts installation - Part 3: Service lifts class V);
- (iv) KS ISO 4190-5 (Lift (Elevator) installation - Part 5: Control devices, signals and additional fittings); or
- (v) KS ISO 8100-30 (Lifts for the transport of persons and goods - Part 30: Class I, II, III, and VI lifts installation); and

(b) have a stability and integrity rating of at least thirty minutes.

(3) An access door shall not be installed within a lift lobby.

(4) A lift well shall have a fire resistance that is not less than the requirements for structural stability in Table 65 set out in the First Schedule, subject to a maximum requirement of two hours, and shall have not more than four lifts accommodated in one subdivision of the shaft.

(5) Where on a storey of a building a lift in a bank of lifts discharges into a division different from that into which the other lifts discharge, the lift shall be accommodated in a separate shaft.

424.(1) A decorative finish or floor covering of a lift shall not have a fire index that exceeds two when tested in accordance with—

Lift design.

- (a) KS 2169-1 (Safety rules for the construction and installation of lifts - Part 1: Electric lifts);
- (b) KS ISO 4190-2 (Lift (US: Elevator) installation - Part 2: Class IV lifts);
- (c) KS ISO 4190-3 (Passenger lifts installation - Part 3: Service lifts class V);
- (d) KS ISO 4190-5 (Lift (Elevator) installation - Part 5: Control devices, signals and additional fittings); or
- (e) KS ISO 8100-30 (Lifts for the transport of persons and goods - Part 30: Class I, II, III, and VI lifts installation).

(2) In a building, the controls of a lift shall, in the event of a fire, shall be design in such a manner that the lift car is brought automatically to the main entrance storey without stopping, and remains there with its doors open.

(3) This paragraph shall not apply to a building classified as having an occupancy of H3 or H4 in Table 1 set out in the First Schedule.

425. (1) A building that exceeds 18m in height shall have one firefighting lift to serve any storey including a basement storey. Firefighting lift.

(2) A firefighting lift shall be in a separate shaft and shall have on each storey a lobby separated from another lobby or space by a wall or a door which shall have a fire resistance of at least two hours.

(3) A firefighting lift shall—

- (a) have internal dimensions of at least 1.1m wide by 2.1m deep;
- (b) have a clear door width of not less than 800mm;
- (c) be clearly identified as a firefighting lift on every storey;
- (d) be able stopping at any storey and have access to all the storeys;
- (e) be kept available for use at all times;
- (f) be subject to independent control during an emergency;
- (g) continue to be workable during an emergency when all other lifts have been brought to the main entrance storey;
- (h) have a source of emergency power to enable the lift to operate together with its lights and extract fan for at least two hours in the event of failure of the mains supply; and
- (i) have means of oral communication to a control point or to a control room where a room is provided.

426. (1) A building which exceeds six storeys in height shall have at least one stretcher lift and that lift shall be 1.1m wide by 2.1m deep, and the entrance to the lift shall be at least 800mm in width. Stretcher lift.



(2) Where the building referred to in sub-paragraph (1) exceeds 30m in height the power supply to the motor operating the stretcher lift shall be protected against a fire for at least two hours.

427. (1) The requirements contained in this paragraph shall apply to a stage or backstage area, including an area beneath a stage that communicates directly with the stage, in a theatre or other occupancy in which a play, opera or other production necessitating the use of scenery take place.

Stage and  
backstage area.

(2) The requirements contained in this paragraph shall not apply in the case of a stage in a school, church hall or other similar place used solely for the presentation of amateur productions, and shall not apply to a stage that does not have a fly gallery.

(3) Any area under paragraph (1) shall be separated from a dressing room, auditorium, workshop, store or any other area within the occupancy, by a wall or floor, which shall have a fire resistance of at least two hours, and any opening, other than the proscenium opening, in the wall or floor shall be protected by a Class B fire door or fire shutter as in Table 66 set out in the First Schedule.

(4) A dressing room shall be at a level lower than the first basement storey.

(5) A proscenium opening shall be protected by a fire curtain which shall—

- (a) be of rigid non-combustible construction, can withstand lateral pressure of 500N/m<sup>2</sup> and a representative specimen of the fire curtain, when tested by the Kenya Bureau of Standards, shall meet the requirements of a Class D door as specified in Table 66 set out in the First Schedule;
- (b) be constructed to slide freely in non-combustible guide rails on both sides of the proscenium opening;
- (c) when fully closed, overlap the proscenium wall, on the stage side, by at least 450mm at each side of the opening, 600 mm at the top and is closed at the bottom onto the stage floor which, if of combustible material, shall not exceed 38mm thick over a non-combustible slab or wall;
- (d) in the case of a fire, descend automatically and close the opening;
- (e) descend completely within thirty seconds and be so regulated that for the last 2m of its descent it does not travel faster than 0.5m/s; and
- (f) be both manually operated and operated by remote control.

(6) Where a stage in a school, church hall or other similar place seating not more than 300 persons, and which is used solely for the presentation of amateur productions, a heavy woollen or non-combustible fibre cloth curtain may be substituted for the fire curtain referred to in sub-paragraph (5).

- (7) An area subject to this paragraph shall have—
- (a) the structure walls, partitions, horizontal slab, roofing and ceiling material, of non-combustible material;
  - (b) the fitted decorative material, of non-combustible material; and
  - (c) the stage floor, of timber supported by a non-combustible floor slab.
- (8) Fire protection equipment shall have—
- (a) an automatic sprinkler system and an automatic drencher system to the stage side of the fire curtain that gives protection in the event of a fire;
  - (b) an acceptable automatic roof ventilation system the effective aggregate area of opening which shall be at least 10% of the area and which shall also be manually operated at the highest point of the roof over the area;
  - (c) a direct communication with the local fire services; and
  - (d) manual alarms in the backstage area in an easily accessible position.
- (9) A dressing room area shall have direct access to an emergency route.

428. (1) In an auditorium, hall or on a grandstand that contains a seating—

Seating arrangement in auditorium, hall or grandstand.

- (a) the seating and an aisle serving the seating shall allow unobstructed movement to the escape routes from the auditorium, hall or grandstand; and
  - (b) the seating shall be at least 21m from an escape door or an access door to an emergency route as measured along the route which a person occupying a seat may be expected to travel to arrive at the escape door or access door.
- (2) The seating on a grandstand, in an auditorium or hall, that is not used for more than one purpose shall be fixed to the building.
- (3) Despite paragraph (2), seating need not be fixed in an auditorium or hall which accommodates not more than twenty-five persons.
- (4) In this paragraph—
- (a) the clearance between rows of seats means the distance as measured between plumb lines from the rearmost part of any seat to the nearest part, including armrests if any, of the seat behind it;
  - (b) in the case of gravity-operated automatic tip-up seats the distance may be measured with the seats in the tipped-up position; and

(c) where individual seats are not provided, every 450 mm of seating space shall be considered to be a seat.

(5) The clearance between a row of seats in an auditorium or hall shall be at least—

(a) 300mm where a person passes not more fourteen seats to leave the row;

(b) 400mm where a person passes between fourteen seats and twenty-four seats to leave the row; or

(c) 500mm where a person passes more than twenty-four seats to leave the row.

(6) The clearance between a row of seats in an outdoor grandstand, where backrests are provided to the seats, shall be at least—

(a) 300mm where a person passes not more than twenty seats to leave the row;

(b) 400mm where a person passes between twenty seats and forty seats to leave the row; or

(c) 500mm where a person passes more than forty seats to leave the row;

(7) The clearance between a row of seats in an outdoor grandstand where backrests are not provided, or on terraced seating, shall have a distance from the front edge of a seat to the front edge of the seat immediately in front of or behind the seat shall be at least 675mm.

(8) An aisle in an auditorium, hall or grandstand, shall have a clear width of at least 1.1m and the surface of the floor and the staircase of the aisle shall be rendered slip resistant and shall be maintained in the slip-resistant condition.

(9) A cross-aisle shall discharge at both ends directly to an emergency route.

(10) The gradient of any aisle which is not level shall not exceed 1 in 8 and a stepped aisle shall not exceed an overall gradient of 1 in 3.

(11) A staircase along an aisle shall be the full width of the aisle and shall be illuminated to at least 2 lux at tread level when normal lighting has been lowered and shall have uniform tread widths and risers.

(12) Where an aisle crosses parallel to the rows of seats and the floor level of the aisle is higher than the adjacent floor level of a row of seats, the edge of the aisle shall have a railing of at least 800mm in height above the floor level of the aisle immediately behind the row.

(13) Where the floor level of a row of seats is higher than the floor level of an adjacent cross-aisle the edge of the floor level of the row shall have the clearance referred to in sub-paragraph (6), with railings in front of all the seats, which shall be at least 800 mm in height above the floor level of the row.

(14) An exit door from an auditorium or hall shall have approved panic bolts, and at no time during occupancy of the auditorium or hall by the public shall the door be locked, obscured, obstructed, covered or hidden.

(15) Floor covering in an auditorium or hall shall be fixed and maintained in a safe condition.

(16) An approved standby system for emergency lighting independent of the normal mains supply shall be provided in a theatre complex or an individual auditorium, hall or grandstand where the total number of seats exceeds 240, or the floor area exceeds 240m<sup>2</sup>, in order to afford a level of illumination of at least 2 lux to enable persons to leave all parts of the theatre complex, auditorium, hall or grandstand in the event of failure of the usual main electricity supply.

(17) Sub-paragraph (16) shall not apply to a stage in a school, church hall or other similar place used solely for the presentation of amateur productions, and shall not apply to a stage that does not have a fly gallery.

(18) The power supply to the emergency lighting shall be safeguarded against the effects of a fire for at least thirty minutes.

429. The floor of an occupancy classified as J4 in Table 1 set out in the First Schedule, shall be of non-combustible material and shall be at least 25mm lower than the threshold of a door leading to an adjoining occupancy.

Parking garage.

430. Where an area in a building is a suite of room used as an operating theatre, maternity delivery room or intensive care unit, the area shall—

Operating theatre or intensive care unit.

- (a) have walls, a floor and ceiling, which separate the area from another area, or from another part of the building, that have a fire resistance of at least two hours;
- (b) have at least two means of exit therefrom;
- (c) have an approved emergency power supply independent of the usual mains supply and operate for at least two hours in the event of failure of the mains supply; and
- (d) have a lift that is used to transport patients therefrom which has an approved emergency power supply independent of the usual main electricity supply and operate for at least two hours in the event of failure of the mains supply.

431. (1) A liquid fuel dispensing pump or storage tank shall not be situated within 3.5m from a lateral boundary or road boundary of a construction site except where the boundary wall has a fire resistance of two hours, is at least 1.8m in height and extends for at least 2m on each side of the pump or tank.

Installation of liquid fuel dispensing pump or tank.

(2) A liquid fuel storage tank shall not be situated within 500mm of another tank except where each tank is located in its own concrete lined pit.

(3) A part of a building, other than a canopy or similar projection, to which an occupant of the building does not have access, shall be erected over a liquid fuel dispensing pump or storage tank except where—

- (a) the underside of the part of the building is at least 3.5m above ground level;
- (b) the part of the building has a fire resistance of at least four hours and extends for at least 2m in every direction beyond the sides of the pump and tank concerned; and
- (c) the floor below the pump, where the pump is erected over a basement storey, has a fire resistance of at least four hours and extends for at least 2m in every direction beyond the sides of the pump and tank concerned.

(4) A petrol dispensing pump shall be erected on a raised plinth of at least 150mm above the surrounding ground level and the plinth shall extend for at least 300mm beyond the perimeter of the base of the pump.

(5) A liquid fuel storage tank and associated equipment shall be constructed and installed in accordance with—

- (a) KS EAS 976 (The petroleum industry - Storage and distribution of petroleum products in above-ground bulk installations); and
- (b) KS EAS 977 (Petroleum industry - Installation of underground storage tanks, pumps/dispensers and pipe work at service stations and consumer installations - Code of practice).

(6) The filler pipe of a liquid fuel storage tank shall be positioned in a masonry or concrete lined chamber that is at least 300mm deep and the pipe shall be clearly identified to indicate its purpose.

(7) A liquid fuel storage tank shall have only one filler pipe, one ventilating pipe and one dipping hole pipe, and the filler and dipping hole pipe shall extend to as near to the bottom of the tank as is practicable.

432. (1) Where on a construction site, liquid petroleum gas is stored in bulk in a vessel which has a capacity that exceeds 500litres the design, erection and protection of a storage facility shall be in accordance with KS EAS 924 (Handling, Storage, and Distribution of Liquefied Petroleum Gas (LPG) in Domestic, Commercial, and Industrial Installations - Code of practice).

Installation of other liquid petroleum tank.

(2) Where a small container is filled with liquid petroleum gas on a construction site—

- (a) the location, design and control of the construction site;
- (b) the filling equipment shall be installed;
- (c) the filling of containers shall be done;

- (d) a storage facility for the gas shall be constructed; and
- (e) the bulk vehicle discharge of the gas shall be in accordance with—
  - (i) KS 1969 (The petroleum industry - The installation of underground storage tanks, pumps/dispensers and pipework at service stations and consumer installations - Code of practice);
  - (ii) KS 1967 (The petroleum industry - Storage and distribution of petroleum products on above ground bulk); and
  - (iii) KS EAS 924-1 (Handling, storage, and distribution of liquefied petroleum gas (LPG) in domestic, commercial, and industrial installations - Code of practice).
  - (iv) (3) Where a tank is installed inside a building and is intended to contain diesel fuel, the installation shall be done in accordance with—
  - (v) KS 1969 (The petroleum industry - The installation of underground storage tanks, pumps/dispensers and pipework at service stations and consumer installations - Code of practice);
  - (vi) KS 1967 (The Petroleum Industry – Storage and Distribution of Petroleum Products on Above Ground Bulk); and
  - (vii) EAS 924 -1 (Handling, storage, and distribution of liquefied petroleum gas (LPG) in domestic, commercial, and industrial installations - Code of practice).

(3) The tank referred to in sub-paragraph (3) shall not be installed on a storey above the ground storey of a building.

433. (1) A building shall not be erected on a construction site unless the construction site has an access for the purposes of firefighting and rescue from the building.

Access to building for firefighting or rescuing purpose.

(2) The interior of a building shall be accessible for rescue purposes by fire services and shall have a system of smoke ventilation from each storey.

(3) This paragraph shall not apply to a part of a building which is to be used as a strong room, record room, security vault, non-habitable computer room or a specific technical area.

(4) An escape door shall be clearly identified from the exterior of the building.

(5) The number of every storey shall be indicated inside an emergency route on an access door.

434. (1) In this paragraph—

Presumed fire  
resistance of  
building material  
or component.

- (a) “Class 1 Aggregate” means a coarse aggregate of foamed slag, blast furnace slag, pumice, burnt clinker, crushed limestone, crushed dolomite, crushed brick or crushed burnt clay product;
- (b) “Class 2 Aggregate” means a coarse aggregate of gravel or crushed natural stone other than limestone or dolomite; and
- (c) “Plaster” means a layer of plaster that is at least 12mm thick and applied to both faces of a wall.

(2) The building materials and components in Table 58, Table 59, Table 60, Table 61, Table 62 and Table 63 set out in the First Schedule, shall satisfy the performance requirements, under fire conditions, provided that the materials and components are in accordance with the relevant detailed descriptions specified therein.

(3) A monolithic unreinforced concrete element or a concrete masonry constructed of solid concrete masonry units in accordance with KS 566 (Specifications for Fire Resistance Tests – Elements of Building Construction) shall be considered to be a solid concrete unit and shall be deemed to have the fire resistance in Table 58 set out in the First Schedule.

(4) The building materials, components, and methods of construction for which sufficient test data is available shall be those in Table 58, Table 59, Table 60, Table 61, Table 62 and Table 63 set out in the First Schedule.

(5) The Kenya Bureau of Standards may assess the fire resistance properties of any material or suitability of any method not specified in this paragraph for use in construction works.

(6) Where concrete structural elements and components are constructed in accordance with this Code, the elements and components may be presumed to have the fire resistance assumed for the purposes of the design in accordance with ISO 8100-1 (Lifts for the transport of persons and goods - Safety rules for the construction and installation of passenger and goods passenger lifts).

435. (1) The building materials listed in sub-paragraph (2) shall satisfy the requirements for non-combustibility when tested in accordance with BS 476-4 (Fire tests on building materials and structures - Non-combustibility test for materials), individually or in combination with each other.

Non-combustible  
building material.

(2) Non-combustible building materials include—

- (a) aluminium (extrusions or castings) fibre-cement;
- (b) fibre-cement products with less than 7.5 % combustible additives;
- (c) brass;

- (d) bricks (burnt clay, lime or sand, cement or sand);
- (e) cement (portland and blast furnace);
- (f) clay (burnt or unburnt);
- (g) concrete;
- (h) furnace slag glass (solid);
- (i) glass fibres (spun, woven or wool, with less than 5% resin content);
- (j) gypsum (with less than 7.5% paper or other combustibles);
- (k) lime;
- (l) metal (other than the alkaline metals);
- (m) mineral wool (with less than 5% resin content);
- (n) mortar (lime, cement, gypsum);
- (o) perlite;
- (p) porcelain;
- (q) pumice;
- (r) steel (cast or rolled);
- (s) stone; and
- (t) natural vermiculite.

(3) An addition of organic or other combustible material may render the material specified in sub-paragraph (2) combustible in accordance with BS 476-4 (Fire tests on building materials and structures - Non-combustibility test for materials) and materials not specified therein are presumed to be combustible except where proved otherwise when tested in accordance with BS 476-4 (Fire tests on building materials and structures - Non-combustibility test for materials).

(4) The metals specified in sub-paragraph (2) may only be considered to be non-combustible when in their solid form and not when in the form of a powder or shavings.

(5) The percentages specified in sub-paragraph (2) are by mass.

436. A sample of a finishing material to be used on a vertical or an overhead horizontal surface shall be tested in accordance with BS 476-4 (Fire tests on building materials and structures - Non-combustibility test for materials) and the values obtained from the test shall be used to calculate the class to the limiting values in Table 73 set out in the First Schedule, and for a given class of material the requirements in columns 2, 3, 4 and 5 of Table 73 shall be individually satisfied.

Surface fire index of material.

437. A sample of a covering shall be tested by the Kenya Bureau of Standards and the values obtained from the test shall be used to calculate the class to the limiting values in Table 74 set out in the First

Fire index of floor covering.



Schedule and for a given class of floor covering the requirements in columns 2, 3, 4 and 5 of Table 74 shall be individually satisfied.

438. (1) An approved fire installation shall be connected to a communication pipe and located at the position and depth determined by the approving authority. Approved fire installation.

(2) A fire installation to be connected to—

- (a) an approved alternative source of supply; or
- (b) a source of non-potable water, where the water is not to be used for a domestic or other purpose which,
- (c) may give rise to health hazard.

439. Water shall not be taken from a supply system for use in a fire installation, unless— Supply of water.

(a) with the permission of the approving authority; and

(b) the use of the water and fire installation is in accordance with any conditions imposed by the approving authority.

440. In a fire installation—

- (a) pumping connections and means of measuring water pressure shall be provided;
- (b) isolating valves shall be provided to control the flow of water to the installation, and to points within the installation; and
- (c) the quantity, pressure and rate of flow of water shall be of such an amount as to be adequate for the supply to a hose reel, hydrant or sprinkler system connected thereto.

Design of fire installation.

441. Where required by the approving authority, provision shall be made in a fire installation for the supply and installation by a local water supplier. Water meter.

442. An isolating valve shall be fitted in a fire installation at a position that does not exceed 1.5m within the boundary. Isolating valve.

443. (1) A fire installation shall be designed to provide—

- (a) a sufficient quantity of water for the effective operation of the number of hose reels, hydrants and sprinkler heads which are operated or come into operation simultaneously in a division;
- (b) flow pressure, in a hose reel or hydrant, of at least 300kN/m<sup>2</sup> and a flow rate of at least 0.5litres per hose reel; and 3litres per second per hydrant; and
- (c) flow pressure and a flow rate at the control valve of a sprinkler system appropriate to the hazard rating of the system.

Fire installation.

(2) In a fire installation—

- (a) the nominal diameter of—
- (i) a communication pipe serving the installation shall be at least 75mm;
  - (ii) a pipe supplying water to a fire hydrant shall be at least 75mm:

Provided that where the length of the pipe exceeds 50m the nominal diameter of the pipe and of the communication pipe to which the installation is connected shall be at least 100mm;

- (b) a service pipe supplying water to a hose reel on one storey of a building shall be at least—
  - (i) 25mm, if it serves one or two hose reels;
  - (ii) 32mm, if it serves three hose reels;
  - (iii) 40mm, if it serves four or five hose reels; and
  - (iv) 50mm, if it serves more than five hose reels;
- (c) a pipe which serves a hydrant and a hose reel installation, or an automatic sprinkler installation, shall have a twin pumping connection;
- (d) a pipe serving a hose reel only shall have a single pumping connection;
- (e) a pipe fitted with at least one fire-pump connection shall be fitted with a pressure gauge which measures up to 2500 kN/m<sup>2</sup> and a reflux valve located in a manner that it shuts off automatically the direct supply of water to the installation whenever and for as long as the fire pump connection is in use.

(3) A reflux valve in a fire installation shall not prevent or hinder the flow of water from a fire-pump connection to a hose reel or hydrant connected to the installation.

(4) A fire installation shall be connected—

- (a) directly to the communication pipe where the local water supply provides pressure and rate of flow required for hose reels contemplated in sub-paragraph (5); or
- (b) to a storage tank of the capacity specified by the approving authority where the local water supplier does not provide the pressure and rate of flow:

Provided that where a fire installation is connected to the storage tank, a pump shall be fitted between the tank and a hose reel, and the pump shall supply water at the topmost hose reel at a pressure of 300kN/m<sup>2</sup>, at a rate of 0.5litres and shall function automatically with the opening of a hose reel nozzle.

(5) The storage tank referred to in sub-paragraph (4) shall be connected, supplied with water and controlled in such a manner that ensures that—

- (a) the point of connection between the storage tank and a supply pipe is above the level of the outlet of the topmost hose reel;
  - (b) the storage tank is supplied with water to fill and to maintain it automatically to its required capacity except when a hose reel connected to it is in use, and where the supply of water is controlled by a ball valve, the valve shall have a diameter of at least 20mm and shall be fitted with a manually operated shut-off valve;
  - (c) a reflux valve is installed on a pipe at a position between the topmost hose reel and the point of connection of the pipe to the storage tank, to cut off the flow of water from the tank whenever and for as long as an associated fire-pump connection is in use; and
  - (d) a manually operated shut-off valve is installed on a pipe at a position between the fire-pump connection and a hose reel supplied by the fire-pump connection, that the flow of water directed to the hose reel may be cut off when the fire-pump connection is not in use.
- (6) Where in a fire installation a hydrant valve or hose reel is installed at a height greater than that at which the county government maintains adequate water supply from its water supply system, or through the equipment of its fire department, the installation shall—
- (a) maintain a flow rate of at least 20litres at a gauge pressure of at least 300kN/m<sup>2</sup> at a hydrant valve connected to the fire installation;
  - (b) have a tank located at or below ground level, which—
    - (i) has a capacity of at least 25,000litres; and
    - (ii) has a service pipe which has a diameter of at least 20mm and is connected to a communication pipe and provided with a pressure gauge which measures up to 2500kN/m<sup>2</sup>, controlled at its outlet by a high-pressure automatic shut-off valve;
    - (iii) is connected to a supplementary service pipe which has a diameter of at least 100mm, a twin fire-pump connection fitted at its inlet and an outlet to discharge into the top of the tank; and
    - (iv) has a gauge that indicates the level of water contained in the tank;
  - (c) have at least two interconnected pump units individually producing, and maintaining the pressure and the flow rate specified in sub-paragraph (1) and shall have—
    - (i) a manual starting mechanism or an automatic starting mechanism, that will start the pump units automatically when a reduction of the static pressure in the fire installation occurs;

provided that the automatic starting mechanism shall be fitted with a manual override control;

- (ii) an electric motor connected to the normal electric power supply and also to a diesel-electric unit which shall start automatically and immediately in the event of failure of the normal electric power supply; and
  - (iii) a delivery pipe whose diameter is at least 100mm, or where a delivery pipe exceeds a height of 50m above the pump, at least 150mm; and
- (d) have a device limiting the gauge pressure at a hydrant valve to 700kN/m<sup>2</sup> under full flow conditions.

(7) A fire installation equipped with automatic pump starting mechanisms shall be fitted with an alarm system designed to emit a continuous audible warning whenever and for as long as a pump installed in the installation is set in motion.

(8) A fire installation equipped with a manual pump starting mechanism shall be kept constantly charged with water and shall at all times be under the supervision and control of a person who is fully conversant with all the technical details of the installation and its warning devices.

(9) An alarm system shall have an alarm cancel button.

(10) A pump unit and its starting and driving mechanisms shall be installed in a ventilated compartment that has a fire resistance rating of at least two hours and where a compartment is located at or below ground level, the entrance or other means of access thereto, shall abut on a road, public place or an open area on the construction site.

(11) Where a compartment is located in a basement, the means of access thereto shall be enclosed by walls having a fire resistance rating of at least two hours and shall not be used as a means of access to any other part of the building.

(12) A building in which a pump forms part of the required fire installation shall have an intercommunication telephone system which may be used by firefighters, and which shall include—

- (a) wall-hung hand-sets, or standard type connections for portable hand-sets, that permit intercommunication between the main entrance to the building, all storeys and all pump and tank rooms;
- (b) where portable hand-sets are installed, at least three of the hand-sets that are kept in a cabinet at the main entrance to the building and each connecting point for a portable hand-set housed in a box with a transparent and easily breakable glass panel; and
- (c) the telephone set in a pump room fitted with loudspeaker equipment of sufficient strength and clarity to transmit a voice distinctly over a distance of at least 5m from the loudspeaker when the pumps are in operation.

444. (1) A building shall have emergency evacuation coordination procedures posted along all floor exits, including in the form of diagrams displayed in a form that would be easily understood by a person.

Evacuation procedures.

(2) The evacuation signs and diagrams for a building shall be located on each evacuation route having regard to the number and location of exits therein.

(3) An evacuation sign or diagram shall be displayed in a conspicuous position and securely attached to a wall or the internal side of a door.

(4) An owner of a building shall put in place arrangements for the evacuation of a person with living with a disability.

445. (1) An owner of a building shall ensure that the fire and evacuation plan for the building is kept in written form.

Fire and evacuation plans.

(2) A fire and evacuation plan shall include the evacuation diagram of the building and where the diagram relates to only a part of the building, it shall be displayed in that part.

(3) A fire and evacuation plan shall take into account the evacuation coordination procedures stated in the fire and evacuation plans for all parts of the building.

(4) A fire and evacuation plan for a part of the building shall complement the evacuation coordination procedures under the fire and evacuation plan for the entire building.

(5) An owner or occupier of a building shall keep a relevant approval document for the building, or a copy of the document, with the building's fire and evacuation plan.

(6) An owner of a building shall—

- (a) ensure that the fire and evacuation plan for the building is made available for inspection in the building during its usual business hours;
- (b) allow a person to inspect the fire and evacuation plan free of charge.

(7) An owner of a building shall—

- (a) carry out a review of the fire and evacuation plan for the building at intervals that do not exceed one year;
- (b) keep a written record of the review; and
- (c) if the building is a high occupancy building, give a copy of the record to the county government within one month after the review.

446. Before any person starts to work in a building, the owner shall give the person general evacuation instructions and first-response evacuation instructions for the building.

Fire and evacuation instructions in a building.

447. (1) The owner or occupier of a building shall give the evacuation coordination instructions for the building, at intervals that do not exceed one year, to—

Evacuation coordination instructions.

- (a) the evacuation coordinator for the building; and
- (b) the persons responsible for carrying out the evacuation coordination procedures under the building's fire and evacuation plan.

(2) The owner or occupier of a building shall give the evacuation coordination instructions, as amended, to the evacuation coordinator and responsible persons as soon as practicable but no later than one month after the amendment.

(3) Before a person becomes an evacuation coordinator, the owner of the building shall bring to the person's attention the evacuation procedures which are in place in respect of the building.

(4) The owner or occupier of a building shall ensure that the fire safety adviser for the building—

- (a) is familiar with the evacuation coordination procedures for the building; and
- (b) gives the evacuation coordination instructions or arranges for the instructions to be given.

448. (1) The owner or occupier of a building shall keep a record of fire and evacuation instructions and practice for each occasion fire and evacuation instructions for the building are given to a person.

Records.

(2) The fire and evacuation instruction record shall state the following—

- (a) the name of each person who is given the instructions;
- (b) the name of the person giving the instructions;
- (c) the date on which the instructions are given;
- (d) a brief description of the instructions given; and
- (e) any action to be taken as a result of the evacuation, including a review of the building's fire and evacuation plan or giving additional fire and evacuation instructions.

449. (1) The owner of an accommodation unit in a building shall display in the unit a sign that—

Owner of an accommodation unit.

- (a) shows the location of—
  - (i) each route from the unit to a place of safety outside the building; and
  - (ii) firefighting equipment and manually operated fire alarms in and near the unit; and
- (b) states the procedures for safely evacuating the building in the event of a fire or hazardous substances emergency.

(2) The sign referred to in sub-paragraph (1) shall be displayed in a conspicuous place in the accommodation unit and attached to a wall or the internal side of a door in the unit.

450. (1) The owner of a building shall ensure that the maintenance of each fire safety installation for the building is carried out by an appropriately qualified person.

Maintenance of fire safety installation.

(2) The owner shall ensure that each fire safety installation for the building is inspected and tested at intervals in accordance with KS-1960 (Maintenance of fire protection equipment – Part 1: Fire hose reels).

(3) A person who is carrying out, or has carried out, maintenance of a fire safety installation for a building and becomes aware, or ought reasonably to be aware of a critical defect in the installation, shall notify the owner of the building about the defect within twenty-four hours after the person carries out the maintenance of the installation.

(4) If the record of maintenance for a fire safety installation for a building indicates that repair or other corrective action is required for the installation, the owner of the building shall ensure that the repair is carried out or the corrective action is taken, within one month after the maintenance of the installation is carried out.

(5) The owner shall prepare a statement related to the maintenance of each prescribed fire safety installation for the building.

(6) The owner shall, within ten working days after the preparation of a statement in accordance with sub-paragraph (5), submit a copy of the statement to the approving authority for approval.

(7) The owner of a building shall keep the statement prepared in accordance with sub-paragraph (5) and the record of maintenance referred to in sub-paragraph (3) for at least two years after the statement or record is prepared.

#### PART XXII—DEMOLITION OF BUILDINGS

451. Where a building containing a basement storey is demolished to ground level, the owner shall provide a safe lateral support to the sides of the basement storey.

Safeguarding of basement.

452. If due to construction works, a road is damaged, the approving authority may either—

Damage to road.

- (a) serve a notice in writing upon the owner, requiring the owner to make good the damage to the road to the satisfaction of the relevant approving authority, within the period specified in the notice; or
- (b) make good the damage and recover from the owner the expenses incurred in doing so.

453. (1) Before demolition works are commenced, an owner shall—

Duties prior to commencement of demolition.

- (a) ensure that no person is in the building or its environs;

- (b) disconnect and remove metres for the supply of gas, electricity, water or other building services, except the cases where the metres may be used in the demolition works;
- (c) disconnect the supply of gas and electricity to the building; and
- (d) remove a fitting attached to the building in connection with a system of road lighting, supply of electricity or other service.

(2) Where a wall of the building abuts or fronts upon a road, service lane or other open area accessible to the public, a contractor shall—

- (a) erect fans or catch platforms along that wall, at the level of the first floor of the building above the level of the road;
- (b) erect fans or catch platforms at the level of the other floors of the building to prevent nuisance from dust or danger from debris or materials, and ensure that the fans or catch platforms are situated at vertical intervals that do not exceed 10m with the uppermost fan or catch platform, situated not more than 10m below the working level;
- (c) erect dust screens to cover the whole of the wall to prevent any nuisance from dust;
- (d) seal all sewer and drainage connections; and
- (e) remove all glazed sashes and doors from the building.

454. (1) Before and during the conduct of demolition works, precautions shall be taken through provision of adequate shoring to prevent, so far as is practicable, accidental collapse of any part of the building, or of any adjoining structures or building, which may endanger any person.

Provision for shoring.

(2) Shoring may be done with approved timber or metal props, which may be vertical, angled or horizontal.

455. An electric cable or other apparatus, other than a cable or apparatus used in the demolition works shall not be electrically charged at any time during the carrying out of demolition works.

Electric cable not to remain charged.

456. At all times during the carrying out of demolition works—

- (a) an owner shall prevent danger to persons and property from risk of fire or explosion through the leakage or accumulation of gas or vapour and from risk of flooding from water mains, sewers or culverts; and
- (b) all external openings to or from the building shall be protected to prevent danger to persons and property.

Preventing danger from fire or explosion.

457. Where chutes are provided for the removal of materials or debris, the chute shall be installed in such a manner that it does not cause danger to any person or property.

Chute for removal of material.



458. (1) All demolition works shall be carried out under the supervision of an architect and engineer. Supervision of demolition works.
- (2) The operations specified in sub-paragraph (3) shall be carried out only—
- (a) under the immediate supervision of an engineer or architect; or
  - (b) by skilled construction workers and under the direction of an engineer or architect.
- (3) The operations referred to in sub-paragraph (1) are—
- (a) the actual demolition of the framework of a building or of a floor, wall, roof or staircase, save where there is no risk of a collapse of any other part of a building in the course of, or as a result of, the demolition works, to endanger a person employed in the demolition works, other than a risk which could not reasonably have been foreseen;
  - (b) the actual demolition of any part of a building where there is a risk of collapse, whether of that part of the building or of any other part of a building, in the course of, or as a result of, the demolition works, to endanger a person employed in the demolition works;
  - (c) the cutting or breaking up or dismantling of reinforced concrete, steelwork or ironwork that forms part of the structure of a building; and
  - (d) the use of any powered mechanical plant or equipment in the actual demolition works.
- (4) Where a powered mechanical plant or equipment is used in demolition works, the operator of that plant or equipment shall be—
- (a) experienced in the operation of the particular plant or equipment; and
  - (b) under the immediate supervision of an engineer or architect.
459. (1) A floor, roof or other part of a building that is being demolished shall not be so overloaded with debris or materials as to render it unsafe or liable to become unsafe. No floors or any other component to be overloaded.
- (2) Debris or materials from demolition works shall not be accumulated against a fence, hoarding or wall in such a manner as to render it unsafe.
460. Where, during the carrying out of a demolition works, steelwork or ironwork is released or dismantled, precautions shall be taken to prevent danger from a sudden twist, spring or collapse. Precautions to be taken in relation to cutting of steelwork.
461. Where, during the carrying out of demolition works, a part of the frame is being removed from a framed or partially framed building, precautions shall be taken to prevent danger from the collapse of the structure. Precautions to be taken in removing framing.

PART XXIII—DISASTER RISK MANAGEMENT ON  
CONSTRUCTION SITES

462. A person undertaking a design, planning, preparation, or construction phase, in the use or demolition of a project shall take account of general principles of disaster prevention in the performance of those duties during all the stages of the project. General principles of disaster prevention.
463. All persons involved in a project and upon whom a duty is placed shall coordinate their activities with one another in a manner which ensures, so far as is reasonably practicable, the health and safety of persons — Co-ordination.
- (a) carrying out the construction works; or
- (b) affected by the construction works.
464. (1) An owner shall ensure that a person designing a structure, or a contractor is promptly provided with pre-construction information. Owners' duty in relation to information.
- (2) The pre-construction information referred to in sub-paragraph (1) shall include information —
- (a) affecting the construction site or the construction works;
- (b) concerning the proposed use of the structure as a workplace;
- (c) relating to the minimum amount of time before the construction phase allowed to the contractors for planning and preparation for construction works; and
- (d) any existing health and safety issues relevant to the construction works.
465. Where a design is prepared or modified outside Kenya for use in construction works in Kenya, the owner or any other person who commissions it shall ensure the design is in accordance with this Code. Designs prepared or modified outside Kenya.
466. (1) A contractor shall not carry out construction works in relation to a project unless the owner is aware of the contractor's duties under this Code. Duties of contractor.
- (2) A contractor shall plan, manage and monitor construction works in a way that ensures that the construction works is carried out with minimal risk to health and safety.
- (3) A contractor shall ensure that a sub-contractor appointed to carry out construction works in relation to a project is informed of the minimum amount of time allowed for planning and preparation before the commencement of the construction works.
- (4) A contractor shall provide a person carrying out construction works under his supervision, with the information and training needed for particular work to be carried out safely and without risk to health, including—
- (a) suitable construction site induction;

- (b) information on the risks, if any, to their health and safety—
  - (i) identified through a risk assessment report approved by the approving authority; and
  - (ii) arising out of the conduct of another contractor which they ought to reasonably be aware of;
- (c) measures identified by the contractor as a result of risk assessment measures needed;
- (d) any construction site rules;
- (e) procedures to be followed in the event of serious and imminent danger to the workers; and
- (f) the identity of the persons nominated to implement those procedures.

(5) A contractor shall provide a person carrying out construction works under his supervision with health and safety training and personal protective equipment required to offer them protection during construction work.

(6) A contractor shall not begin work on a construction site unless the construction site is hoarded.

467. (1) An owner shall maintain a health and safety file which shall contain all health and safety information relating to a project, construction site or structure.

Health and safety file.

(2) Where a single health and safety file relates to more than one project, construction site or structure, or where it includes other related information, the owner shall ensure that the information relating to each project, construction site or structure can be easily identified.

(3) A health and safety file maintained in accordance with subparagraph (1) shall include—

- (a) a brief description of the construction works being carried out;
- (b) any hazards that have not been eliminated through the design and construction processes, and how they have been addressed;
- (c) the key structural principles and safe working loading for the floors and roofs of the building;
- (d) the hazardous substances used in the project;
- (e) information relating to the removal or dismantling of installed plant and equipment;
- (f) information relating to the equipment provided for cleaning or maintaining the structure;
- (g) the nature, location and positions of building services, including underground cables, gas supply equipment and fire-fighting services; and

(h) as-built drawings of the building, its plant and equipment.

(4) An owner shall ensure that after the construction phase the information in the health and safety file is kept available for inspection and is reviewed as often as may be appropriate to incorporate new relevant information.

(5) An owner who disposes of the owner's entire interest in a project, construction site or structure shall deliver the health and safety file thereof, to the person who acquires the interest.

468. (1) There shall be suitable and sufficient safe access to a place of construction works or another place provided for the safe use of a person while at the construction works, which access shall be properly maintained.

Safe place of work.

(2) A construction site shall be made and kept safe for, and without risks to health to, a person at work.

(3) Suitable and sufficient measures shall be taken to ensure that a person cannot access a place of construction works or another place provided for the use of a person while at the construction works, unless it is in accordance with this Code.

(4) A place of construction works or another place provided for the use of a person while at the construction works shall have sufficient working space and be suitable for a person who is working or who is likely to work there, taking account of the necessary work equipment present.

469. (1) Every part of a construction site shall be kept in good order and in a reasonable state of cleanliness.

Good order and construction site security.

(2) A construction site shall—

- (a) have its perimeter identified by suitable signs which shall be arranged to be identifiable; or
- (b) be fenced off.

(3) Timber or other material with projecting nails, or similar sharp object, shall not be—

- (a) used in construction works; or
- (b) if the nails, or similar sharp object, could cause physical harm to any person, allowed to remain in a place.

470. (1) Practicable steps shall be taken to—

Stability of structure.

(a) prevent danger to any person; and

- (b) ensure that a new or existing structure, or a part of the structure which may become unstable in a temporary state of weakness or instability due to the carrying out of construction work, does not collapse.

(2) A buttress, temporary support or temporary structure, shall be designed, installed and maintained to withstand a foreseeable load which may be imposed, and only be used for the purposes for which it is designed, installed and maintained.

(3) A part of a structure shall not be loaded in a manner that renders it unsafe to a person.

(4) Where work cannot safely be carried out on or from the ground part of a building, or other permanent structure, there shall be provided and maintained scaffolds, or where appropriate, ladders or other means of support, which shall be suitable and sufficient for the purpose.

(5) For the purpose of this paragraph, a wall, which is less than 600mm wide, shall not be deemed to be a permanent structure.

471. (1) A scaffold shall not be erected, added, altered or dismantled except under the supervision of a contractor. Scaffold.

(2) An engineer shall inspect all scaffolds before they are used.

(3) A scaffold shall be constructed as designed by an engineer.

(4) Sufficient material shall be provided and used in the construction of a scaffold.

(5) Timber used in the construction of a scaffold shall not be painted or treated in such a manner that defects are concealed.

(6) A metal part used for a scaffold shall be free from corrosion or other patent defects which might materially affect the strength of the scaffold.

472. (1) A working platform which is at a height that exceeds 2m shall— Working platform.

(a) if used as a footing only and not for the deposit of a material, be at least 635mm wide;

(b) if used for the deposit of material, be at least 865mm wide and have a clear passageway that is at least 430mm wide between one side of the working platform and the deposited material;

(c) if used for the conveyance of materials, afford a clear passageway for the passage of the materials without removal of the guard- rails and toe-boards that is at least 635mm wide;

(d) if used for the support of a higher platform, be at least 1065mm wide;

(e) if used to dress or roughly shape stone, be at least 1295 mm wide;

(f) if used for the support of a higher platform upon which stone is dressed or roughly shaped, be at least 1.5m wide; and

(g) in every case, be of sufficient width to afford adequate working space at every part of it.

(2) Subject to sub-paragraph (4), the following working platforms shall be at least 430mm wide—

- (a) a platform—
- (i) of a ladder scaffold or supported directly by folding trestles or folding step ladders, or under a roof used for work on or in the vicinity of the roof, which is supported by or suspended from, roof members or the roof, in a case where the work thereon is of light nature and for a short duration in one position; and
  - (ii) less than 635mm or 865mm wide (as the case may be) and can be used with safety; and
- (b) a platform which is used for work in connection with cylindrical or spherical metal structures.

(3) Where work at the face of a building or other structure, is done from a working platform, the space between the face and the working platform shall be as small as practicable:

Provided that, where workmen sit at the edge of the platform to work, the space shall not exceed 305mm.

(4) Sub-paragraphs (1) and (2) shall not apply to a working platform where it is impracticable, by reason of limitations of space, to provide a platform of the width required therein:

Provided that the platform shall be as wide as is reasonably practicable.

473. (1) A side of a working platform or working place which is at a height that exceeds 2m shall have a guarding designed by an engineer.

Guarding.

- (2) The guarding referred to in sub-paragraph (1) shall have—
- (a) a height of between 915mm and 1145 mm above the platform or working place, and above a raised standing place on the platform; and
  - (b) toe-boards or other barriers, up to a height which shall be at least 150mm.

(3) The handrails, toe-boards or other barriers referred to in sub-paragraph (1) shall be installed so as to prevent falling by persons, materials or articles from the platform or working place.

(4) The outward movement of guarding, toe-boards or other barriers referred to in sub-paragraph (1) shall, unless designed and used to prevent movement, be protected by placing them on the inside of the uprights.

(5) Where guarding is required, the distance between the toe-boards or other barriers, and the lowest handrail above it shall not exceed 765mm.

(6) The handrails, toe-boards and barriers referred to in sub-paragraph (1) may be removed or remain un-erected to facilitate access by persons or the movement of materials or other purposes of construction works and shall be replaced or erected as soon as practicable.

(7) On the side of a suspended scaffold next to a wall or working face—

- (a) guarding where required by this paragraph, need not extend to a height that exceeds 685mm above the platform if the construction work is impracticable with guardrails at a greater height; and
- (b) handrails, toe-boards or other barriers, shall not be required if the workers sit at the edge of the platform to work and ropes or chains affording all the workers safe, and secure handholds are provided.

(8) Sub-paragraph (7) shall not apply to—

- (a) the platform of a ladder scaffold if a secure handhold is provided along the full length of the platform;
- (b) the platform of a trestle scaffold when the platform is supported on folding trestle, split heads or similar devices or folding step ladders;
- (c) a platform used only in the course of erecting a framework or prefabricated unit which—
  - (i) forms part of a building or other permanent structure for the purpose of jointing, bolting up, riveting or welding work; and
  - (ii) is used for a short period and if the platform is at least 865mm wide, with adequate handholds or if the platform is not used for the deposit of rail or articles.

474. (1) In an opening, corner, break or edge, through or from which an article may fall from a height that exceeds 2m, or a person may fall into a liquid or material and risk drowning or serious injury, there shall be—

Preventing falling.

- (a) a suitable guarding designed by an engineer to a height of between 915mm and 1145mm above the surface across which persons may pass, together with toe-boards;
- (b) placed to prevent falling of persons, materials or articles and to ensure space between a toe-board or other barrier, and the lowest handrail above shall not exceed 765mm, other barriers up to a height of at least 155mm; or
- (c) a covering constructed to prevent the fall of persons, materials or articles, which is clearly and boldly marked to show its purpose or is securely fixed in position.

(2) In the case of an opening, corner, break or edge, not being an opening, corner, break or edge, through or from which materials or articles may fall endangering persons below it, suitable precautions

such as toe-boards, secure covering or otherwise, shall prevent materials or articles from falling.

(3) When construction works are carried out on or immediately above an open joisting through which a person may fall from a distance that exceeds 2m, the joisting shall—

- (a) be securely covered by boards or other temporary covering as supervised by a contractor; and
- (b) be provided with safety nets.

(4) Handrails, toe-boards, barriers and coverings required by this paragraph may be removed or remain un-erected where necessary to proceed with a permanent filling in, covering or enclosure or for the access by persons, the movement of materials or other purposes, and shall be replaced or erected as soon as practicable.

(5) An adequate supply of timber of suitable quality, or other suitable material shall, where necessary, be provided and used to prevent danger to a person, from falling, or dislodgement of earth, rock or other material that form the side of, or are adjacent to an excavation or earthwork.

(6) Where, having regard to the nature and slope of the side of the excavation or earthwork or other circumstances, no fall or dislodgement of earth or other material likely to bury or trap a person, or likely to strike a person from a height that exceeds 1220mm, may occur.

475. (1) A contractor shall not use a naked slab as a means of support where roofing is carried out by laying stone slabs on steel joists or on beams.

Suitable plank.

(2) Suitable planks supported by joists or beams shall be provided for the workmen on a construction site.

476. (1) A ladder used in construction work shall be of sound material, good construction and adequate strength for the purpose for which it is used, with rungs evenly spaced.

Ladder.

(2) A ladder shall not stand on loose stones or other loose packing, but shall have a level and firm footing.

(3) Where a ladder is used as a means of connection, adequate handholds shall be provided to a height of at least 915mm above the place of landing.

(4) A ladder shall not be used if it has—

- (a) a missing or defective rung; or
- (b) a rung which is supported solely on nails, spikes, or other similar fixing.

(5) A wooden ladder shall not be used unless it is constructed with—

- (a) uprights of adequate strength made of straight-grained wood free from defects and having the grain of the wood running lengthwise; and



(b) rungs made of straight-grained wood free from defects and mortised or securely notched into the uprights.

(6) If a ladder is at least 635mm in length, it shall be secured at the top.

(7) A ladder reaching to a platform or roof shall rise at least 915mm above the landing place.

(8) Where a ladder is used as a means of connection and is at least 3.05m in length, a person shall be stationed at the foot of its lower end to prevent it from slipping.

(9) A ladder shall be secured to the ground where possible, or to a solid anchorage, in such a manner as to prevent the ladder from slipping.

(10) A ladder used by stone carriers shall—

(a) have a distance that does not exceed 180mm between the upper edge of one rung and the upper edge of the next rung; and

(b) be at least 765mm wide at the base.

477. (1) A material shall not be placed or stacked near the edge of an excavation, pit or opening in the ground in a manner likely to endanger persons below the excavation, pit or opening.

Position of material.

(2) A load shall not be placed or moved near the edge of an excavation where it is likely to cause a collapse of the side of the excavation and endanger a person.

478. (1) Effective measures shall be taken to secure and maintain adequate ventilation of a working place in an excavation, pit, hole, adit, tunnel shaft, caisson or other enclosed or confined space.

Securing and ventilation of working place.

(2) The measures referred to in sub-paragraph (1) shall be for the purpose of—

(a) maintaining an atmosphere fit for respiration; and

(b) rendering harmless any fumes, dust or other impurities which may be dangerous or injurious to health, and which may be generated, produced or released by explosives, or by other means in construction site in an excavation, pit, hole, adit, tunnel shaft, caisson or other enclosed or confined space.

(3) Where there is apprehension that the atmosphere of a construction site, an excavation, pit, hole, adit, tunnel shaft, caisson or other enclosed or confined space is poisonous or asphyxiating, a person shall not be allowed in that space until the atmosphere has been suitably tested by a geologist or government chemist, and certified to be free of danger.

(4) A stationery internal combustion engine shall not be used in an enclosed or confined space unless specific provision is made for conducting the exhaust gases from the engine into the open air or the place is ventilated to prevent danger to health from the exhaust gases.

(5) A flywheel, moving part of any prime mover, transmission machinery or dangerous part of other machinery, whether or not driven by mechanical power, shall be securely fenced unless it is as safe for every person working on the construction site as it would be if it were securely fenced.

(6) A crane, crab and winch shall have efficient brakes, or other safety device which prevents the load from falling when suspended, and by which the load is effectively controlled whilst being lowered.

479. (1) A skip and a bucket shall be at least 765mm deep and constructed of metal.

Skip and bucket.

(2) A skip and a bucket, suspension ropes and chains or other means of support shall be free from any defect.

(3) A person loading a skip from below, shall stand clear when the skip is raised, and enough space shall be provided for the person binding the skip from below it, to stand clear when the skip is raised.

480. (1) A person employed in construction works shall wear suitable boots made of strong material that completely covers all the toes when engaged in processes involving the use of cement.

Safety measures when handling cement or lime.

(2) A person engaged in plastering or whitewashing in a manner that the application of the plaster or lime to the object being treated is made at a level higher than the eyes of the person, shall wear suitable eye shields.

481. (1) Demolition works or dismantling works, shall be planned and carried out in a manner that prevents or reduces danger.

Demolition works or dismantling works.

(2) An owner shall ensure that the plan for carrying out demolition works or dismantling works shall be in writing and prepared before the demolition works or dismantling works begins.

(3) An owner shall ensure that the plan referred to in subparagraph (2) is submitted to the approving authority for approval before the demolition works or dismantling works begins.

(4) In carrying out demolition works, efforts shall be made to reduce wastage, and recycle salvaged materials.

482. (1) An explosive used in construction works shall be stored, transported and used safely and securely.

Explosive.

(2) An explosive charge shall be used only if—

(a) suitable and sufficient measures have been taken to ensure that no person is exposed to risk of injury from the explosion or from material caused to project or fly from the explosion; and

(b) the contractor has obtained the necessary permit.

(3) Explosives shall not be handled or used except—

(a) by or under the control of a competent person with adequate knowledge of the dangers connected with its use; and

- (b) measures having been taken to ensure that when a charge is fired, persons working in the construction works are in positions in which they are not exposed to the risk of injury from the explosion.

(4) In this paragraph “competent person” means a person who is qualified and registered under the relevant law by virtue of his experience and training.

483. (1) Practicable measures shall be taken where necessary to prevent danger to a person, including the provision of supports or buffering, to ensure that—

- (a) an excavation or part of an excavation does not collapse;
- (b) material from a side or roof of, or adjacent to, an excavation, is not dislodged or does not fall; and
- (c) a person is not buried or trapped in an excavation by material which is dislodged or falls.

(2) Suitable and sufficient measures shall be taken to prevent—

- (a) a person, work equipment, or accumulation of material from falling into an excavation; and
- (b) a part of an excavation or ground adjacent to it from being overloaded by work equipment or material.

(3) Construction works shall not be carried out in an excavation where supports or buffering have been provided unless—

- (a) the excavation and work equipment and materials which affect its safety have been inspected by an engineer—
  - (i) at the start of the shift in which the work is to be carried out;
  - (ii) after any event likely to have affected the strength or stability of the excavation; and
  - (iii) after a material unintentionally falls or is dislodged;
- (b) structural ramps to be utilized by equipment for entry to or exit from the excavation have been inspected by an engineer; and
- (c) the engineer is satisfied that the work can be carried out safely.

(4) Where an engineer who has carried out the inspection under sub-paragraph (3) has informed the owner about a matter that the engineer is not satisfied with, no work shall be carried out in the excavation until the matter is satisfactorily remedied.

(5) For an excavation which exceeds 3m in depth, the engineer shall—

- (a) prepare and submit a method statement for excavation to the approving authority; and

- (b) design sloping and shoring in line with the relevant codes of practice for geotechnical engineering.

484.(1) Every cofferdam or caisson shall be—

Cofferdam or caisson.

- (a) of suitable design and construction;
- (b) appropriately equipped so that workers gain shelter or escape if water or materials enter it; and
- (c) properly maintained.

(2) A cofferdam or caisson shall be used to carry out construction work only if—

- (a) the cofferdam or caisson, and any work equipment and materials which affect its safety, have been inspected by an engineer—
  - (i) at the start of the shift in which the work is to be carried out; and
  - (ii) after any event likely to have affected the strength or stability of the cofferdam or caisson; and
- (b) the engineer is satisfied that the work can be safely carried out there.

(3) Where the engineer who carried out the inspection issues a report of not being satisfied on safety or otherwise, construction works shall not be carried out in the cofferdam or caisson until the matters have been satisfactorily remedied.

485. (1) An engineer who carries out an inspection in accordance with paragraph 482 or 483 shall—

Reports.

- (a) before the end of the shift within which the inspection is completed where not satisfied that the construction work can be carried out safely at the place inspected, inform the person on whose behalf the inspection was carried out; and
- (b) within twenty-four hours of the inspection, prepare a report and submit it to that person.

(2) A person on whose behalf the inspection referred to in subparagraph (1) was carried out shall keep the report available for inspection by the approving authority—

- (a) at the construction site in respect of which the inspection was carried out until that work is completed, and for three months after the completion of the construction works; and
- (b) provide the approving authority with the extracts from or copies of the report.

486. (1) Where in the course of construction works a person may fall into water or another liquid and there is a risk of drowning, suitable and sufficient measures shall be put in place—

Prevention of drowning.

- (a) to prevent the person from falling;

- (b) to minimize the risk of drowning; and
- (c) to ensure that suitable rescue equipment is provided, maintained and, when necessary, used so that the person may be promptly rescued in the event of falling.

(2) Suitable and sufficient measures shall be taken to ensure safe transport of a person conveyed over water to or from a place of work.

(3) A vessel used to convey a person over water to or from a place of work shall not be overcrowded or overloaded.

487. (1) A contractor shall organise the construction site in a manner such that pedestrians and vehicles are able to move safely and without risk to health.

Traffic route.

(2) A traffic route shall be suitable for the persons or vehicles using them, sufficient in number, in suitable positions and of sufficient size.

(3) A traffic route shall be organised in such a manner that—

- (a) pedestrians or vehicles may use it without causing danger to the health or safety of persons near it;
- (b) a door or gate for pedestrians which leads onto a traffic route is sufficiently separated from that traffic route to enable pedestrians to see an approaching vehicle or machinery from a place of safety;
- (c) there is sufficient separation between vehicles and pedestrians to ensure safety or, where this is not reasonably practicable —
  - (i) there is provided other means for the protection of pedestrians; and
  - (ii) there are effective arrangements for warning a person who may be crushed or trapped by a vehicle, of its approach;
- (d) a loading bay has at least one exit point for the exclusive use of pedestrians; and
- (e) where it is unsafe for pedestrians to use a gate intended primarily for vehicles, at least one door for pedestrians is provided in the immediate vicinity of the gate, is clearly marked and is kept free from obstruction.

(4) Every traffic route shall be—

- (a) indicated by suitable signs;
- (b) regularly checked; and
- (c) properly maintained.

(5) A vehicle shall not be driven on a traffic route unless that traffic route is free from obstruction and permits sufficient clearance.

488. (1) Suitable and sufficient measures shall be taken to prevent or control the unintended movement of a vehicle and to ensure that, where a person may be endangered by the movement, the person having effective control of the vehicle shall give suitable warning.

Vehicle in construction site.

(2) A vehicle being used for construction works shall be operated or towed, or loaded in a safe manner.

(3) A person shall not ride, or be required or permitted to ride, on a vehicle being used for construction work otherwise than in a safe place thereon provided for that purpose.

(4) A person shall not remain, or be required or permitted to remain, on a vehicle during the loading or unloading of loose material unless a safe place of work is provided and maintained for the person.

(5) Suitable and sufficient measures shall be taken to prevent a vehicle from falling into an excavation or pit, into water, or overrunning the edge of an embankment or earthwork.

489. Suitable and sufficient measures shall be taken to prevent the risk of injury to a person, during the carrying out of construction works arising from—

Prevention of risk from fire and other hazards.

- (a) a fire or an explosion;
- (b) flooding; or
- (c) any substance that may cause asphyxiation.

490. (1) An owner shall prepare and implement, suitable and sufficient plans for dealing with an emergency, including procedures for an evacuation of the construction site or any of its parts.

Emergency procedures.

(2) In making the plans referred to in sub-paragraph (1), an owner shall take account of—

- (a) the type of work for which the construction site is being used;
- (b) the characteristics and size of the construction site and the number and location of the places of work on that construction site;
- (c) the work equipment being used;
- (d) the number of persons likely to be present on the construction site at any one time; and
- (e) the physical and chemical properties of any substances or materials on or likely to be on the construction site.

(3) In the preparation of the plans referred to in sub-paragraph (1), an owner shall take suitable and sufficient measures to ensure that the plans are brought to the attention of all persons at the construction site and are tested for effectiveness at suitable intervals.

491. (1) There shall be provided in every construction site, a sufficient number of suitable emergency routes and exits to enable any person to reach a place of safety quickly.

Emergency route or exit.

(2) An emergency route or exit shall lead as directly as possible to an identified safe area.

(3) An emergency route or exit and a traffic route referred to in paragraph 486, shall be kept clear and free from obstruction and shall have emergency lighting.

(4) Suitable signs shall indicate all emergency routes or exits.

492. (1) In every construction site there shall be provided suitable and sufficient firefighting equipment and fire detection and alarm systems, which shall be suitably located and secure.

Fire detection and firefighting.

(2) Any fire-fighting equipment and any fire detection and alarm system shall be examined and tested at suitable intervals and shall be properly maintained, and where it is not designed to come into use automatically it shall be easily accessible.

(3) Every person at work on a construction site shall be instructed on the correct use of any fire-fighting equipment that it may be necessary for the person to use.

(4) Where a work activity may give rise to a particular risk of fire, a person shall not carry out the work unless the person is suitably instructed.

(5) Suitable signs shall indicate the location of fire-fighting equipment.

493. (1) Suitable and sufficient measures shall be taken to ensure that a place of work has sufficient fresh or purified air to ensure that the place is safe and without risk to health.

Fresh air.

(2) Where machinery is used for the purposes of sub-paragraph (1) an effective device shall be installed to give a visible or audible warning of a failure of the machinery.

494. (1) Suitable and sufficient measures shall be taken to ensure that during working hours, the temperature at a place of work which is indoors is reasonable, having regard to the purpose for which that place is used.

Temperature and weather protection.

(2) A person who is working at a place of work which is outdoors shall, where necessary, be provided with protective clothing or work equipment and the clothing shall provide protection from adverse weather.

495. (1) A construction site and a traffic route shall have suitable and sufficient lighting by natural light.

Lighting.

(2) The colour of artificial lighting provided to a construction site shall be provided so as not to adversely affect or change the perception of a sign or signal provided.

(3) Suitable and sufficient secondary lighting shall be provided in a construction site in the event of failure of the primary artificial lighting.

PART XXIV—ACCESS ROADS, CUL-DE-SACS AND OTHER  
PRIVATE ROADS

496. (1) A private road or cul-de-sac shall be accessible from an existing road or another new road. Private road.

(2) An access or alteration to an existing access to a construction site shall be situated and constructed to the satisfaction of the approving authority.

497. (1) A private road or cul-de-sac shall have a footpath of a width of at least 2m on either side. Footpath.

(2) An access road shall have a footpath on at least one side.

(3) A private road, cul-de-sac and an access road shall have a safe cyclist lane and designated parking spaces.

(4) A footpath shall be protected in such a manner as to prevent vehicles entering thereon and well drained.

(5) A footpath shall be surfaced with concrete that is at least 50mm thick, and covered with granolithic paving that is at least 12.5mm thick or any other approved design.

498. In a residential area—

Width of private road or cul-de-sac.

(a) the width of a carriageway and footpath in a private road shall be at least that specified in Table 76 set out in the First Schedule; and

(b) the width of a carriageway of a cul-de-sac shall be at least 5m and the width of each footpath thereon shall be at least 2m.

(2) In an industrial area—

(a) the width of a carriageway or footpath in a private road shall be at least that specified in Table 76 set out in the First Schedule; and

(b) the width of a carriageway of a cul-de-sac shall be at least 7m and the width of a footpath thereon shall be at least 2.75m.

(3) For the purposes of this paragraph a cul-de-sac which exceeds 120m in length measured along the centre line of the carriageway thereof from the junction of the cul-de-sac with a road which is a thoroughfare, shall be considered to be a private road.

(4) In this paragraph—

“industrial area” means a zone within a county restricted for industrial purposes and includes the land or buildings thereon; and

“residential area” means a zone restricted for use exclusively for residential purposes and includes land reserved for open spaces, sports grounds or land reserved for public purposes.



499. (1) Subject to sub-paragraph (2), the width of the carriageway of an access road shall be at least 6m and the width of the footpath thereon shall be at least 2m. Width of access road.
- (2) Where—
- (a) an access road provides access to not more than twelve separate buildings or not more than twenty-four multi-dwelling units, whether the multi-dwelling units are in the same building or not;
  - (b) the aggregate of the areas of the floors in all the buildings or flats does not exceed 3500m<sup>2</sup>; and
  - (c) the spaces, to enable vehicles to pass, are provided at distances along the access road that do not exceed 60m in length.
500. At a junction of a private road, cul-de-sac or access road, with a road, the radius of the kerb line shall— Kerb radius.
- (a) be at least the width of a footpath, where the footpath in the private road, cul-de-sac or access road is of the same width as the road; or
  - (b) be at least the width of the widest footpath, where the footpaths in the private road, cul-de-sac, access road, and the road, are of different widths.
501. The junction of a private road, cul-de-sac or access road, with a road shall be constructed at right angles, and— Junction to be at right angle.
- (a) where the junction is of a new private road or cul-de-sac, with an existing road, the line of the carriageway of the new private road or cul-de-sac, shall continue at the right angle for a distance of at least 30m from the place at which the road or cul-de-sac enters the junction;
  - (b) where the junction is of at least two new private roads, the line of the carriageway or of each road shall continue at the right angle for a distance of at least 30m from the place at which each road enters the junction; and
  - (c) where the junction is of an access road with a road, the line of the carriageway of the access road shall continue at the right angle for a distance of at least 7.5m from the place at which the access road enters the junction.
502. At the junction of a carriageway of a minor road with a carriageway of a major road, the carriageway of the minor road shall be graded in such a manner as to avoid undulation on the major road. No undulation onto major road.
503. (1) A private road, cul-de-sac or access road shall not have a gradient that exceeds 1 in 6. Gradient.
- (2) Despite sub-paragraph (1), in a private road or cul-de-sac, the gradient shall not exceed 1 in 30, for a distance of 30m from the junction of the private road or cul-de-sac, with a road.

(3) Despite sub-paragraph (1), in an access road, the gradient shall not exceed 1 in 30, for a distance of 7.5 m from the junction of the access road, with a road.

504. (1) The radius of a horizontal curve in a private road or cul-de-sac shall be at least 30m measured to the centreline of the carriageway of the road or cul-de-sac.

Horizontal curve.

(2) The radius of a horizontal curve in an access road shall be at least 9m, measured to the centreline of the carriageway of the access road.

505. A vertical curve in a private road, cul-de-sac or access road, shall be such that from a point 1m above any part of the carriageway thereof, a clear view can be obtained of the top of an object 1m in height at all distances along the carriageway up to 40m from the point.

Vertical curve.

506. Where the approving authority permits the radius of a horizontal curve in a private road or cul-de-sac to be less than 30m, the carriageway shall be gradually widened, on the outer edge of the curve, from the tangent points to the middle point of the curve, so that at the middle point of the curve, the widening is not less than that in Table 77 set out in the First Schedule.

Widening of private road or cul-de-sac on curve.

507. (1) There shall be provided, at the closed end of every cul-de-sac, adequate space to enable a vehicle to turn.

Turning space for vehicle in a cul-de-sac or access road.

(2) Where an access road is not a thoroughfare, there shall be provided at that end of the access road, adequate space to enable a vehicle to turn.

508. (1) The carriageway of a private road, cul-de-sac or access road, shall have—

Surfacing of private road, cul-de-sac or access road.

- (a) a sub-base course of at least 150mm in thickness that has—
  - (i) natural material (gravel or coral) of California bearing ratio of at least 30; or
  - (ii) crushed stone material with a particle size that does not exceed 50mm;
- (b) a base course of at least 150mm in thickness and made of—
  - (i) cement or bitumen stabilized crushed stone material;
  - (ii) graded crushed stone material; or
  - (iii) hand packed stone (hard core); and
- (c) a surface course made of a layer of fine bitumen macadam or an asphaltic wearing course of at least 25mm in thickness or other approved material such as precast concrete paving blocks of at least 50mm on a sand bed of at least 30mm in thickness.

(2) Where cement concrete is used instead of the base course referred to in sub-paragraph (1) (b), the thickness shall be at least 150mm on cement stabilized sub-base material, gravel or crushed stone of at least 100mm thick, or any other approved material

509. A service lane shall be surfaced with—
- Surfacing of service lane.
- (a) concrete that is at least 75mm thick laid on crushed stone that is at least 100mm thick;
  - (b) gravel that is at least 100mm thick, laid on rolled hard-core that is at least 100mm thick, and covered with a layer of fine bitumen macadam that is at least 25mm thick; or
  - (c) any other approved material.
510. (1) A kerbstone shall be 125mm in width, 250mm in height and at least 600mm in length.
- Kerbstone.
- (2) A kerbstone may be constructed of concrete or any other approved material.
511. The top of every kerb shall be between 100mm and 150mm above the level of the channel adjacent thereto.
- Height of kerb.
512. (1) The carriageway therein shall have a camber of 1 in 40, unless a bend in a private road, cul-de-sac or access road is super-elevated.
- Camber at cross fall.
- (2) A footpath shall have a cross fall towards the kerb of 1 in 50.
513. (1) A manhole cover or grating situated in the carriageway of a private road, cul-de-sac or access road, shall be of the Grade as specified in—
- Grade of manhole cover or grating.
- (a) KS 1555-1 (Gully tops and manhole tops for vehicular and pedestrian areas - Part 1: Definitions, classification, general principles of design, performance requirements and test methods);
  - (b) KS 1555-2: (Gully tops and manhole tops for vehicular and pedestrian areas - Part 2: Gully tops and manhole tops made of cast iron);
  - (c) KS 1555-3:(Gully tops and manhole tops for vehicular and pedestrian areas - Part 3: Gully tops and manhole tops made of steel or aluminium alloys);
  - (d) KS 1555-4: (Gully tops and manhole tops for vehicular and pedestrian areas - Part 4: Gully tops and manhole tops made of steel reinforced concrete);
  - (e) KS 1555-5: (Gully tops and manhole tops for vehicular and pedestrian areas - Part 5: Gully tops and manhole tops made of composite materials); or
  - (f) KS 1555-6:(Gully tops and manhole tops for vehicular and pedestrian areas - Part 6: Gully tops and manhole tops made of polypropylene (PP), polyethylene (PE) or unplasticized polyvinyl chloride) (PVC-U).
- (2) A manhole cover or grating in a footpath, pedestrian way or service lane shall be of Grade B as specified in KS 1555 (Gully tops and manhole tops for vehicular and pedestrian areas).

514. (1) The cover of a manhole in a private road, cul-de-sac or access road, pedestrian way or service lane, provided for a drain or sewer for the carriage of foul water shall be rectangular.

Shape of manhole cover.

(2) The cover of a manhole for a drain or sewer for the carriage of surface water shall be round.

515. (1) A private road, cul-de-sac, access road, footpath or service lane shall have channels, drains and sewers for the carriage of rain-water and surface water to a storm water drain.

Drainage of private road.

(2) The size and gradient of the channel, drain or sewer referred to in sub-paragraph (1) shall be designed to carry off all rain-water and surface water from the private road, cul-de-sac, access road, footpath or service lane, to a collection point.

(3) The intensity of rainfall used in designing the size and gradient of a channel, drain or sewer under sub-paragraph (2) shall be calculated—

- (a) where the time of concentration is less than thirty minutes, at the rate of at least 150mm/h; and
- (b) where the time of concentration is at least thirty minutes, at the rate of at least 100mm/h.”

516. (1) A channel in a private road, cul-de-sac, access road or footpath shall be—

Channel in private road.

- (a) constructed of concrete that is at least 150mm in thickness and at least 300mm in width, or any other approved material;
- (b) laid to a fall of at least 1 in 30 towards the kerb at the cross-section; and
- (c) laid to a fall of at least 1 in 100 at the longitudinal section.

(2) Where it is impracticable to lay a channel to a fall of at least 1 in 100 at a longitudinal section, the channel may be laid to a fall of at least 1 in 250.

(3) Work on a public road shall be carried out by the approving authority.

(4) Where—

- (a) the forming or laying out of a private road, cul-de-sac, access road or footpath; or
- (b) the provision of a means of access to a building fronting or abutting a public road,

necessitates the carrying out of construction work in, or the alteration of, a public road, the work or alteration, shall be carried out as approved by the approving authority.

#### PART XXV—MISCELLANEOUS

517. The Local Government (Adoptive By-Laws) (Building) Order, 1968 is revoked.

Revocation of L. N. 15 of 1968.

SCHEDULES  
FIRST SCHEDULE—TABLES  
SECOND SCHEDULE—FIGURES  
FIRST SCHEDULE  
TABLES

TABLE 1—CLASSIFICATION OF OCCUPANCY IN BUILDINGS

(p. 17(5)(6), 42, 119, 141(24), 151, 164(1), 201(2), 203(10), 204(1)(2)(4), 362, 364(1), 368(2)(5), 369(6), 371(2)(4), 374, 383(2)(3), 384(3), 384(2), 386(6), 387, 388(1)(2), 390(1), 391(9), 392(1), 393(4), 394(3), 396(3)(4), 400(1), 401(11), 403(1), 406(6), 407(4)(5), 408(1)(3)(4), 410(2), 412(2)(6), 414(5), 419(1), 424(3), 429)

CLASS OF BUILDING	OCCUPANCY OF BUILDING
A1	<i>Entertainment and Public Assembly</i> Occupancy where persons gather to eat, drink, dance or participation other recreation.
A2	<i>Theatrical and Indoor Sport</i> Occupancy where persons gather for the viewing of theatrical, operatic, orchestral, choral, cinematography or sport performance.
A3	<i>Places of Instruction</i> Occupancy where school children, students or other persons assemble for the purpose of tuition or learning.
A4	<i>Worship</i> Occupancy where persons assemble for the purpose of worshipping
A5	<i>Outdoor Sport</i> Occupancy where persons view outdoor sports events.
B1	<i>High risk commercial service</i> Occupancy where a non-industrial process is carried out and where either the material handled or the process carried out is liable, in the event of fire, to cause combustion with extreme rapidity or give rise to poisonous fumes, or cause explosions.
B2	<i>Moderate risk commercial service</i> Occupancy where a non-industrial process is carried out and where either the material handled or the process carried out is liable, in the event of fire, to cause combustion with moderate rapidity but is not likely to give rise to poisonous fumes, or cause explosions.
B3	<i>Low risk commercial service</i> Occupancy where a non-industrial process is carried out and where neither the material handled nor the process carried out fails into the high or moderate risk category.
C1	<i>Exhibition hall</i> Occupancy where goods are displayed primarily for viewing by the public.
C2	<i>Museum</i> Occupancy comprising a museum, art gallery or library.

D1	<p style="text-align: center;"><i>High risk industrial</i></p> <p>Occupancy where an industrial process is carried out and where either the material handled or the process carried out is liable, in the event of fire, to cause combustion with extreme rapidity or give rise to poisonous fumes, or cause explosions.</p>
D2	<p style="text-align: center;"><i>Moderate risk industrial</i></p> <p>Occupancy where an industrial process is carried out and where either the material handled or the process carried out is liable, in the event of fire, to cause combustion with moderate rapidity but is not likely to give rise to poisonous fumes, or cause explosions.</p>
D3	<p style="text-align: center;"><i>Low risk industrial</i></p> <p>Occupancy where an industrial process is carried out and where neither the material handled nor the process carried out falls into the high or moderate risk category.</p>
D4	<p style="text-align: center;"><i>Plant room</i></p> <p>Occupancy comprising usually unattended mechanical or electrical services necessary for the running of a building.</p>
E1	<p style="text-align: center;"><i>Place of detention</i></p> <p>Occupancy where people are detained for punitive or corrective reasons or because of their mental condition.</p>
E2	<p style="text-align: center;"><i>Hospital</i></p> <p>Occupancy where people are cared for or treated because of physical or mental disabilities and where they are generally bed-ridden.</p>
E3	<p style="text-align: center;"><i>Other institutional (residential)</i></p> <p>Occupancy where groups of people who either are not fully fit, or who are restricted in their movements or their ability to make decisions, reside and are cared for.</p>
F1	<p style="text-align: center;"><i>Large shop</i></p> <p>Occupancy where merchandise is displayed and offered for sale to the public and the floor area exceeds 250m<sup>2</sup>.</p>
F2	<p style="text-align: center;"><i>Small shop</i></p> <p>Occupancy where merchandise is displayed and offered for sale to the public and the floor area does not exceed 250m<sup>2</sup>.</p>
F3	<p style="text-align: center;"><i>Wholesaler's store</i></p> <p>Occupancy where goods are displayed and stored and where only a limited selected group of persons is present at any one time.</p>
F4	<p style="text-align: center;"><i>Building of the warehouse class</i></p> <p>A building designed or lawfully used as a warehouse, go-down or factory, or for carrying on a wholesale business, but does not include any living accommodation which may form part of or be annexed to such building, and the formation of an access to a construction site.</p>

G1	<i>Offices</i> Occupancy comprising offices, banks, consulting rooms and other similar usage.
H1	<i>Hotel</i> Occupancy where persons rent furnished rooms, not being dwelling unit.
H2	<i>Dormitory</i> Occupancy where groups of people are accommodated in one room.
H3	<i>Domestic residence</i> Occupancy consisting of at least two dwelling units on one construction site.
H4	<i>Dwelling house</i> Occupancy consisting of a dwelling unit on one construction site, including a garage and other domestic outbuildings, if any.
J1	<i>High risk storage</i> Occupancy where material is stored and where the stored material is liable, in the event of fire, to cause combustion with extreme rapidity or give rise to poisonous fumes, or cause explosions.
J2	<i>Moderate risk storage</i> Occupancy where material is stored and where the stored material is liable, in the event of fire, to cause combustion with moderate rapidity but is not likely to give rise to poisonous fumes, or cause explosions.
J3	<i>Low risk storage</i> Occupancy where the material does not fall into the high or moderate risk category.
J4	<i>Parking garage</i> Occupancy used for storing or parking of more than 10 motor vehicles

TABLE 2—GARAGE SPACES

(p. 35)

<i>Class of Building</i>	<i>Garage spaces per 100m<sup>2</sup> of gross built area</i>
A3, B1, B2, B3, C1, C2, D1, D2, D3, E1, E3, F3, H3, H4	1 (one)
A2, A5, E2, F1, F2,	2
A1, A4, G1, H1	2.5

TABLE 3—LORRY PARKING AND LOADING BAYS

(p. 46(c))

X draw forward	Y centres	W o/a width	L o/a length for 5	Area per vehicle (sq.)	X draw forward		Y centres		W o/a width	L o/a length for 5	Area per Sq. gross	Vehicle (m.) net
1	5.0	27.4	22.5	123	4	4.	8	18.4	39,5	145	113	
2	4.4	28.4	20.1	114	5	4.	5	19.1	37.8	144	111	
3	4.0	29.4	18.5	109	6	4.	2	19.8	36.1	144	108	
4	3.7	30.4	17.3	105	7	3.	9	20.5	34,4	141	105	
5	3.4	31.4	16.1	101	8	3.	6	21.2	32,7	139	101	
6	3.0	32.4	14.5	94	9	3.	4	21.9	31,6	138	100	
					10	3.	2	22,6	30,5	138	98	
Lorry parking and loading bays - head-on; for the					11	3.	1	23,4	29,9	140	99	
largest vehicles.					12	3.	0	24,1	29,3	141	99	

TABLE 4—ROOF SLOPES AND SHEET END LAPS

(p. 65(2), 241(2))

Class	Roof covering Description	Minimum angle of slope (degrees)	Minimum end lap, mm	
			End laps sealed	End laps not sealed
A	Corrugated metal, plastic or glass-reinforced plastic sheets (including box rib)	5	250	Not permitted
		11	150	250
		15	150	225
		17	150	200
		22	150	150
	Corrugated fibre-cement sheets	11	200	300
		15	175	275
		17	150	250
		22	150	200
		26	150	150
	Long span specialised metal sheets	5	As required by the approving authority	
	Single length long span and specialised sheets	3		
B	Fibre-cement slates (i) with an approved underlay	10		
		17		



Class	Roof covering Description	Minimum angle of slope (degrees)	Minimum end lap, mm	
			End laps sealed	End laps not sealed
	(ii) without an approved underlay			
	Single-lap concrete or clay interlocking tiles; concrete, clay plain tiles or shingles (i) with an approved underlay (ii) without an approved underlay	17 26		
	Natural slate on open battens (i) with an approved underlay (ii) without an approved underlay	20 30		
	Thatch: Thickness of 150mm Thickness of 300mm	45 35		
C	Metal tiles (i) with an approved underlay (ii) without an approved underlay	10 15		

TABLE 5—CLASSIFICATION AND BEARING CAPACITY OF SUB SOILS

(p. 86(1), (5))

Type of Soil	Condition	Max. permissible bearing capacity in kN per square meter
Alluvial	Firm	30
Made up ground: Clay Red Soil	Loose or wet	30
Sand	Wet or badly drained	50
Red Soil	Normal	75
Red Soil	Firm or hard, dry and well drained	100
Coral	Soft vesicular	100

<i>Type of Soil</i>	<i>Condition</i>	<i>Max. permissible bearing capacity in kN per square meter</i>
Sand	Dry, well drained or protected	100 to 150
Murram mixture	Firm and well drained	150
Brown shale	Weathered	150
Gravel Turf, soft Magadi, soft	Compact in layers	200
Brown shale	Un-weathered	200
Coral	Medium hard	200
Murram	Uniform, firm and compact minimum 1.2m thick in layers	300
Murram black Turf Magadi	Firm minimum 1.2m thick	400
Magadi, hard Nairobi soft stone Rock, soft	Monolithic test-bores required	600
Hard Nairobi stone or black-trap	Monolithic test-bores required	600-1000

TABLE 6—PLANNED DIMENSIONS OF A ROOM

(p. 88(3))

<i>Class of Building</i>	<i>Room</i>	<i>Minimum plan area</i>
All classes	Any habitable room other than a kitchen, scullery or laundry	7.0m <sup>2</sup> with no linear dimension of less than 2.1 linear metres.
B, D or J	Change rooms and dining rooms	For an occupancy of 1-15, 0.8m <sup>2</sup> - 7.0m <sup>2</sup> per person For an occupancy of 16 -100, 0.6m <sup>2</sup> - 12m <sup>2</sup> per person For an occupancy of more than 100, 0.5m <sup>2</sup> - 60m <sup>2</sup> per person

TABLE 7—ROOM DIMENSIONS

(p. 89(1))

<i>Room or Space</i>	<i>Minimum Height</i>
Bedroom	2.4m over a floor area of at least 7m <sup>2</sup> with a clear height of at least 1.8m at any point more than 0.75m from the edge of the floor space.
Any other habitable rooms other than dwelling house or dwelling unit	2.4m over a minimum of 70% of the floor area, not less than 2.1 m over the remaining floor area.
All habitable rooms other than those listed above	2.4m
Passage or entrance hall	2.4m
Bathroom, shower-room, laundry or room containing a water closet	2.1 m over any area where a person would normally be in a standing position.
Open mezzanine floor which has an area not exceeding 25% of the area of the floor immediately below it	2.1m above and below the mezzanine floor.

TABLE 8—FLOOR JOISTS FOR RESIDENTIAL BUILDINGS

(p. 100(3))

	<i>Maximum clear spans (in m) with joists at following centres</i>					
	<i>Centres</i>					
	300mm	350mm	400mm	450mm	500mm	600mm
<i>Section (mm)</i>						
75 x 50	1.5	1.2	1.2		1.2	1.2
100 x 50	1.8	1.8	1.8		1.5	1.5
125 x 50	2.5	2.0	2.0		2.0	1.8
150 x 50	3.0	2.7	2.7		2.4	2.4
175 x 50	3.3	3.3	3.0		2.7	2.7
200 x 50	3.9	3.6	3.6		3.3	3.0
225 x 50	4.5	4.2	3.9		3.6	3.6
275 x 50	5.4	5.1	4.8		4.5	4.2
150 x 75			3.0	3.0	3.0	2.5
175 x 75			3.5	3.5	3.5	3.0
200 x 75			4.0	4.0	4.0	3.5
225 x 75			5.0	4.5	4.5	4.0
275 x 75			6.0	6.0	5.5	5.0

TABLE 9 — STRENGTH OF MASONRY UNITS AND MORTAR

(p. 104(3))

Wall type	Position		Minimum average compressive strength, (KN/m <sup>2</sup> )		Class of mortar required
			Solid	Hollow	
Structural other than foundation and retaining walls	Single storey building	External or Internal	7.0	3.5	II
	Single above storey building	External or Internal	10.5 or *14.0	7.0	II or I
Non-structural other than parapet, balustrade and free-standing walls	External		7.0	3.5	II
	Internal		7.0	3:5	III
Free-standing	External or		10.5	7.0	II
Foundation	Supporting single storey		7.0	3,5	II
Foundation	Supporting double storey		10.5 or 14.0	7.0	II or I
Parapet			7.0	3.5	II or I
Balustrade			7.0	3.5	II
Retaining			10.5	7.0	II

## CLASSES OF MORTAR

(p. 104(4), 126)

Class	<i>Mix Proportions (Parts by volume)</i>		
	<i>Portland Cement</i>	<i>Lime</i>	<i>Sand (Measured loose or damp)</i>
I	2	3	4
II	1	0.5	4
III	1	1	6
IV	1	2	8

\*Addition of Lime is optional

TABLE 11 – DIMENSIONS OF MASONRY WALLS IN BUILDINGS

(p. 105(1)(6)(8))

<i>Nominal wall thickness (mm)</i>	<i>Use of wall in a building</i>	<i>Maximum storey height (m)</i>	<i>Maximum height ground floor to top of external gable (m)</i>	<i>Maximum un-supported length (m)</i>	<i>Minimum nominal unit strength (KN/m<sup>2</sup>)</i>		<i>Minimum class of mortar</i>
					Hollow units	Solid units	
90	Non-structural internal wall in any storey.	3.0	NA	4.0	7.0	3.5	III
	External infilling and cladding to framed building to height of 25m.	3.3	NA	note (3)	7.0	NP	II
	Wall providing lateral support in single storey building but carrying no gravity load other than its own weight.	3.0	NA	4.0	7.0	3.5	. II
140	Non-structural internal wall in any storey.	3.0	NA	6.0	7.0	3.5	III

<i>Nominal wall thickness (mm)</i>	<i>Use of wall in a building</i>	<i>Maximum storey height (m)</i>	<i>Maximum height ground floor to top of external gable (m)</i>	<i>Maximum un-supported length (m)</i>	<i>Minimum nominal unit strength (KN/m<sup>2</sup>)</i>		<i>Minimum class of mortar</i>
	External infilling and cladding to framed building to height of 25m.	3.0	NA	5.0	7.0	3.5	II
	Structural wall in single storey building.	3.3	5.0	6.0	7.0	3.5	II
	Structural wall in double storey building.	3.0	6.0	6.0	10.5	7.0	II
190	Non-structural internal wall in any storey.	3.5	NA	8.0	7.0	3.5	111
	External infilling and cladding to framed building to height of 25m.	3.3	NA	7.0	7.0	3.5	II
	Structural wall in single storey building.	3.5	5.5	7.0	7.0	3.5	II
	Structural wall in double storey building.	3.3	8.0	7.0	10.5	7.0	II
230	Non-structural internal wall in any storey	4.0	NA	8.0	7.0	3.5	111
	External infilling and cladding to framed building to height of 25m.	3.3	NA	8.0	7.0	3.5	II
	Structural wall in single storey building.	4.0	6.0	8.0	7.0	3.5	II

<i>Nominal wall thickness (mm)</i>	<i>Use of wall in a building</i>	<i>Maximum storey height (m)</i>	<i>Maximum height ground floor to top of external gable (m)</i>	<i>Maximum un-supported length (m)</i>	<i>Minimum nominal unit strength (KN/m<sup>2</sup>)</i>		<i>Minimum class of mortar</i>
	Structural wall in double storey building	3.3	8.0	8.0	10.5	7.0	II
90-50-90 To	External infilling and cladding to framed building to height of 25m	3.3	NA	5.0	7.0	3.5	II
90-110-90	Structural wall in single storey building	3.0	4.5	7.0	7.0	3.5	II
cavity wall	Structural wall in double storey dwelling unit without concrete slab roof.	2-8	7.5	7.0	14.0	NP	II
140-50-140 To	External infilling and cladding to framed building to height of 25m.	3.3	NA	6.0	7.0	3.5	LI
140-110-140	Structural wall in single storey building.	3.0	5.0	8.0	7.0	3.5	II
cavity wall	Structural wall in double storey building.	3-0	8.0	8.0	14.0	7.0	II
* NA means NOT APPLICABLE. * NP means NOT PERMITTED							

TABLE 12—TIMBER FRAMED STRUCTURES

(p. 105 (2))

Wall type	Stud size (mm)	Stud spacing (mm)	Maximum panel length		*Max. height (m)	Max. storey height (m)
			Supported both ends	Supported one end		
Structural	100x50	400	4.8	2.4	6.0	4.0
	100 x 50	600	4.0	2.0	6.0	3.0
	75x50	450	3.8	1.8	3.0	3.0
Non-structural	100x50	600	4.8	3.0		4.0
	70x50	600	4.2	2.4		3.0

\*Maximum height means height to wall plate of highest storey or height to top of gable if there is a gable

TABLE 13—THICKNESS OF FOUNDATION WALLS

(p. 109(3))

Type of foundation wall		Minimum thickness of wall(mm)						
		Acting as a retaining wall			Not acting as a retaining wall			
		* Difference in ground level (mm)			Height(mm)			
		Less than 500	500 to 750	750 to 1000	Less than 300	300 to 500	500 to 1000	1000 to 1500
Single leaf brick	External	140	190	230	140	140	140	190
	Internal		190	230	90	140	140	190
Single leaf hollow block (cavities filled with concrete)	External	140	190	230	140	140	140	190
	Internal	140	190	230	90	140	140	190
Cavity walls (cavity filled to 150mm below damp-proof course level)	External	190	190	230	190	190	190	190



TABLE 14—FREE STANDING WALLS

(p. 113(1), (5))

<i>Nominal wall thickness (mm)</i>	<i>Maximum height of wall above finished ground (m)</i>		<i>Piers</i>	
	<i>Without piers</i>	<i>With piers</i>	<i>Nominal dimensions (projection x width) (mm)</i>	<i>Max. spacing (centre to centre) (m)</i>
90	0.8	1.2	200 x 290	1.8
110	1.0	1.4	240 x 230	1.8
140	1.3	1.6	300 x 290	2.0
190	1.5	2.0	400 x 290	2.5
230	1.8	2.3	480 x 350	3.5
290	2.2	2.6	400x290	4.5

TABLE 15—RETAINING WALLS

(p. 114(7))

<i>Nominal wall thickness (mm)</i>	<i>Max. height of fill to be retained (m)</i>	<i>Piers</i>	
		<i>Nominal dimensions (projection x width) (mm)</i>	<i>Max. spacing (centre to centre) (m)</i>
190	0.8- 1.1	300x190	No piers required 2.0
	1.3	400x190	2.4
230	0.9- 1.4	360 x 230	No piers required 2,5
	1.5	480 x 230	2.7
290	1.1- 1.5	300x290	No piers required 2.7
390	1.4	No piers required	

TABLE 16—TYPES OF ROOF ANCHORS

(p. 115(6))

Roof slope (degrees)	Max. roof truss, rafter or beam spacing (mm)	Type of anchor required	
		Light roof	Heavy roof
Less than 15	760 1,050 1,350	A, B or C B or C C	Type A for all applications
15 to 30	760 1,050 1,350		
Greater than 30	Any	A, B or C	
Note— type A, which consists of two strands of a 4mm galvanized steel wire; type B, which consists of a 30mm x 1.2mm galvanized steel strap; or type C, which consists of a 30mm x 1.6mm galvanized steel strap.			

TABLE 17—RAIN PENETRATION TEST PERIOD

(p. 117(2)(4)(5))

Mean annual rainfall* (mm)	Hourly mean wind speed* (m/s)	Minimum period (hours)
More than	20	14
+1000	25	19
	30	24
	20	10
600-1000	25	15
	30	20
	20	6
200 – 600	25	11
	30	16
	20	2
0-200	25	7
	30	12
Note— *See BS6399 Part 3 of 1996 for the general procedures and loadings to be adopted for the design of buildings; +1000 is based on a maximum rainfall of 1400mm; and where the actual annual rainfall is known to exceed 1400mm the figures for duration of test may be linearly extrapolated.		

TABLE 18—DIMENSIONS OF NON-LOAD-BEARING WALL

(p. 122(1))

<i>Height</i>	<i>Length</i>
0.66m	3 m
0.83m	3.33 m
1m	4m
1.33m	4.66m
1.50m	5m
2m	6.66m
2.91m	8.33m
<p>Note—            where both the length and the height of a wall, partition or panel, exceed these dimensions, it shall be divided by vertical and horizontal supports of the strength and rigidity that the condition herein is fulfilled;            the wall, partition or panel, shall be supported along two vertical opposite ends;            the wall, partition or panel, shall be supported along two horizontal opposite ends, where required; and            the supported ends of the wall, partition or structure, shall be attached to the main structure by bonding, inserted into a groove, or by any other approved method of fixing.</p>	

TABLE 19—LENGTH OF ZONE OF SPACE

(p. 137(9)(10))

<i>Type of room served by opening</i>	<i>Length of zone of space</i>
Habitable room in dwelling house, dwelling unit or a building used for a residential- or institutional occupancy	1/3 H
Any other habitable room	1/5 H
Bathroom, shower or room containing a Water Closet pan or urinal	1/10 H
<p>Where H represents the distance measured vertically from the head of the opening to the top of the wall containing the opening.</p>	

TABLE 20 – VENTILATION RATES FOR NATURAL VENTILATION  
(p. 138(7), 141(5))

<i>Building Type/Facility</i>	<i>Ventilation Rates in Air Changes per Hour (ACH)</i>
Broadcasting studios	6-10
Offices including Call centres	4-6
Catering (inc. commercial kitchens)	30-40
Communal residential buildings	0.5-1
Dwellings (inc. high rise dwellings)	0.5-1
Hotels	10-15 for guest rooms with ensuite bathrooms
High rise (non-domestic buildings)	4-6 for office areas Up to 10 for meeting rooms
Schools	4-6
Dark rooms (photographic)	6-8
Laboratories	6-15
Standards rooms	45-60
Transportation buildings	6 ACH for car parks (normal operation) 10ACH (fire conditions)
Toilets	Opening windows of area 1/20th of floor area or mechanical ventilation at 6 litres/s per water closet or 3ACH minimum for non-domestic buildings.

TABLE 21 – VOLUMETRIC FLOW OF AIR FOR ARTIFICIAL (FORCED MECHANICAL) VENTILATION  
(p. 141(24), 156(d))

<i>Occupancy</i>	<i>Minimum Volumetric flow of air (litres/second)</i>		<i>Remarks</i>
	<i>Smoking</i>	<i>Filtered or non-smoking</i>	
<i>Public halls</i>			
Assembly halls	7.5	3.5	Air supply required per person
Churches	7.5	3.5	

Theatres (including lobbies and auditoria)	7.5	3.5	
Cinemas	7.5	3.5	
<i>Dry-cleaners and laundries</i>			
Commercial dry-cleaners (working areas)	-	120.0	Air supply required per person
Storage or collection area	7.5	5.0	
Laundries	7.5	5.0	
<i>Educational buildings</i>			
Classrooms	-	7.5	Air supply required per person
Laboratories	-	7.5	
Libraries	-	6.5	
<i>Food and eating facilities (public)</i>			
Dining-rooms and restaurants	7.5	5.0	Air supply required per person
Cafeterias	7.5	5.0	
Bars and cocktail lounges	7.5	5.0	
Kitchens	17.5	17.5	
Photographic darkrooms	-	10.0	Air supply required per person
<i>Dwelling units</i>			
Kitchens	50.0	50.0	Air supply required per person
Other living areas	5.0	5.0	
Bathrooms and shower-rooms	25.0	25.0	
Rooms containing a water closet pan or urinal	25.0	25.0	
Shops Malls, arcades, warehouses	7.5	7.5	Air supply required per room
Sales floors, showrooms, dressing rooms	7.5	7.5	
<i>Sports and amusement facilities</i>			
Ballrooms and discos	7.5	—	Air supply required per room
Bowling alleys (seating area)	7.5	—	
Playing area (gymnasium, etc)	—	10.0	
Locker-rooms	7.5	7.5	
Spectator areas	5.0	-	
Health spas and slimming salons	-	7.5	

Garages Parking garages Ticket kiosks Motor car repairs	7.5	3.5	Air supply required per sq. of floor area
	5.0	5.0	Air supply required per person
	10.0	10.0	Air supply required per sq. of floor area
Hotels, motels, resorts, dormitories and similar facilities Lobbies Conference rooms Assembly rooms Bedrooms Living-rooms (suites) Central kitchens Private kitchens	7.5 7.5 7.5	5.0 5.0 5.0	Air supply required per person
	7.5 7.5 17.5 50.0	17.5 50.0	Air supply required per person Air supply required per room
Libraries General Book stock	— —	6.5 3.5	Air supply required per person
Offices General Meeting and waiting spaces Conference and board rooms Cleaner's rooms	7.5 7.5 10.0	5.0 5.0 5.0	Air supply required per person
	—	1.0	Air supply required per sq. of floor area
Stages, TV, radio and movie film	7.5	5.0,	Air supply required per person
Rooms containing baths, showers, WC pans or urinals Serving a dwelling unit or any bedroom All others Transportation Waiting-rooms, ticket and baggage areas, corridor & gate areas, platforms, concourses	25.0	25.0	Air supply required per room
	20.0 7.5	20.0 7.5	Air supply required per bath,

	5.0 7.5	-	*Shower, WC pan, urinal stall or 600mm of urinal space
		5.0	Air supply required per person
Smoking-rooms	20.0	-	Air supply required per person
Occupancies other than those listed above		As determined by the approving authority	
	10.0	10.0	Air supply required per sq. of floor area
Hotels, motels, resorts, dormitories and similar facilities Lobbies Conference rooms Assembly rooms Bedrooms Living-rooms (suites) Central kitchens Private kitchens	7.5 7.5 7.5	5.0 5.0 5.0	Air supply required per person
	7.5 7.5 17.5 50.0	17.5 50.0	Air supply required per person Air supply required per room
Libraries General Book stock	— —	6.5 3.5	Air supply required per person
Offices General Meeting and waiting spaces Conference and board rooms Cleaner's rooms	7.5 7.5 10.0	5.0 5.0 5.0	Air supply required per person
	-	1.0	Air supply required per sq. of floor area
Stages, TV, radio and movie film	7.5	5.0,	Air supply required per person
Rooms containing baths, showers, WC pans or urinals Serving a dwelling unit or any bedroom All others Transportation Waiting-rooms, ticket and baggage areas, corridor & gate areas, platforms, concourses	25.0	25.0	Air supply required per room

	20.0 7.5 5.0 7.5	20.0 7.5 —	Air supply required per bath, *Shower, WC pan, urinal stall or 600mm of urinal space
		5.0	Air supply required per person
Smoking-rooms	20.0	—	Air supply required per person
Occupancies other than those listed above		As determined by the approving authority	

TABLE 22—AIR CHANGES PER HOUR

(p. 141(5)(6))

<i>Building Type/Facility</i>	<i>Recommended Ventilation Rates in Air Changes per Hour (ACH)</i>	
<i>Assembly Halls and Auditoria</i>		
	Using displacement ventilation strategy	3-4
	Using High level mechanical ventilation strategy	6-10
<i>Sports Centres</i>		
	Fitness Centres	10–12
	Weight Training	10-12
	Squash Courts	4
	Ancillary Halls: -Sports -spectators	15 3
	Changing rooms	10
	Reception, administration and circulation spaces	3
	Creche	3
	Refreshment and bar areas	Not less than 8
	Swimming pool	4-6 8-10 if extensive water features
<i>Hospitals and Health Care Buildings</i>		
	Toilets — general — ensuite	10 6
	Bathrooms — general — ensuite	10 6
	Dirty utility room	10
	Changing rooms	5



	Isolation rooms	10 minimum
	Delivery rooms	10 minimum
	Recovery rooms	15
	Treatment rooms	6 minimum

TABLE 23—NUMBER OF SANITARY FIXTURES TO BE INSTALLED RELATIVE TO THE OCCUPANCY

(p. 156(a), 246(1), 261(3)(5))

<i>For occupancy of up to</i>	<i>Males</i>				<i>Females</i>		
	<i>Water closet pans</i>	<i>Urinals</i>	<i>Wash hand basins</i>	<i>Showers</i>	<i>Water closet pans</i>	<i>Wash hand basins</i>	<i>Showers</i>
10	1	1	1	2	2	1	2
20	1	2	2	2	3	2	2
30	2	2	3	3	5	3	3
40	3	3	3	3	6	3	4
60	3	4	4	5	7	4	5
80	4	5	5	5	9	5	5
100	5	6	5	6	10	5	6
	For an occupancy in excess of 100 add 1 water closet pan and 1 urinal for every 100 Persons	For an occupancy in excess of 100 add 1 wash hand basin for every 100 persons	For an occupancy in excess of 100 add 1 shower for every 40 persons	For an occupancy in excess of 100 add 1 water closet pan and 1 wash hand basin for every 80 persons	For an occupancy in excess of 100 add 1 shower for every 40 persons		

TABLE 24—PERMISSIBLE DISCHARGE PIPE LOADING  
(p. 156(a), 246(1), 264(1))

<i>Maximum loading (fixture units)</i>			
<i>Nominal pipe diameter (mm)</i>	<i>Discharge stack pipes</i>	<i>Fixture discharge pipes and branch discharge pipes</i>	<i>Horizontal discharge pipes other than pipes referred to in column 3</i>
32	2	1	1
40	6	2	3
50	18	5	8
65	84	18	35
75	140	29	60
100	680	120	280
125	2400	350	870
150	6000	760	2100

TABLE 25—MID FREQUENCIES REVERBERATION TIMES FOR PUBLIC PERFORMANCE SPACES

(p. 159)

<i>Activity</i>	<i>Reverberation Time (seconds)</i>	<i>Building Type</i>
Broadcast	0.2-0.25	Sound dubbing.
	0.3	Announcer booths.
	1.0 – 2.0	Large music studios.
Speech	0.6-1.2	Small speech studios, council chambers, law courts, lecture theatres, meeting rooms and conference halls.
Drama	0.9-1.4	Theatres and function rooms.
Amplified sound	0.5-1.2	Multiplex cinemas, pop concert venues, discotheques and video wall settings.
Multiuse	1.0-1.7	School assembly halls, community halls, sports halls and arts halls.
Opera	1.0-1.6	Opera houses and theatres with orchestra pits.
Soloists, ensembles	1.2-1.7	Recital halls, orchestra rehearsal halls and chamber music salons.
Orchestral music	1.7-2.2	Concert halls.
Organ and choir music	2.0-5.0	Ceremonial halls, organ concert halls, churches and cathedrals.

TABLE 26—DAYLIGHT FACTORS AND LIMITING GLARE INDEXES  
(p. 160(7))

<i>Situation</i>	<i>Average daylight factor (%)</i>	<i>Minimum daylight factor* (%)</i>	<i>Position of measurement</i>	<i>Limiting daylight glare Index</i>
<i>Assembly and concert halls</i>				
Foyers, auditoria	1	0.6	Working plane	24
Corridors	2	0.6	Floor	—
Stairs	2	0.6	Treads	—
<i>Drawing offices</i>				
General	5	2.5	On boards	21
<i>General building areas</i>				
Entrance halls and reception areas	2	0.6	Working plane	24
<i>Offices</i>				
General offices	5	2	Desks	23
Typing, business machines, manually operated computers	5	2.5	Desks	23
<i>Schools and colleges</i>				
Assembly halls	1	0.3	Working plane	21
Classrooms	5	2	Desks	21
Art rooms	5	2	Easels	21
Laboratories	5	2	Benches	21
Staffrooms, common rooms	5	1.5	Working plane	23
<i>Sports halls</i>				
General	5	3.5	Working plane	21

<i>Surgeries (medical and dental)</i>				
Waiting rooms	2	0.6	Working plane	24
Surgeries	5	2.5	Working plane	21

TABLE 27—DIMENSIONS FOR VERTICAL GLASS SUPPORTED IN A FRAME ALL ROUND IN EXTERNAL WALLS IN BUILDINGS WHERE THE HEIGHT MEASURED FROM GROUND TO TOP OF SUCH WALL DOES NOT EXCEED 10 METERS

(p. 173(2), 177)

<i>Nominal thickness of pane (mm)</i>	<i>Maximum pane area (m<sup>2</sup>)</i>					
	3	4	5	6	8	10
Monolithic annealed glass (ordinary glass)	0.75	1.5	2.1	3.2	4.6	6.0
Toughened safety glass	n/a	1.9	3.0	4.5	8.0	8.0
Laminated safety glass	n/a	n/a	2.2	3.0	4.3	5.7
Grade B patterned annealed & wired glass	n/a	0.75	1.2	1.9	2.6	3.4

TABLE 28—DIMENSIONS FOR VERTICAL GLASS SUPPORTED IN A FRAME ALL ROUND IN INTERNAL WALLS

(p. 173(2), 177)

<i>Nominal thickness of pane (mm)</i>	<i>Maximum pane area (m<sup>2</sup>)</i>					
	3	4	5	6	8	10
Monolithic annealed glass (ordinary glass)	0.75	1.5	2.1	3.2	4.6	6.0
Toughened safety glass	n/a	3.0	4.2	6.4	9.2	9.2
Laminated safety glass	n/a	n/a	4.1	6.0	7.2	7.2
Grade B patterned annealed & wired glass	n/a	0.75	1.2	1.9	2.6	3.4

TABLE 29—MAXIMUM THICKNESS OF CERTAIN MATERIALS

(p. 192(2))

	<i>Granite</i>	<i>Stone</i>	<i>Precast concrete</i>	<i>Marble</i>	<i>Profile sheet steel</i>
Up to 20 m from the ground floor	30mm	30mm	75mm	30mm	Not applicable
Over 20m above the ground level	40mm	40mm	100mm	40mm	Not applicable
Maximum panel sizes permissible	1.2m vertically, 0.6m horizontally				Not applicable

TABLE 30—MINIMUM DIMENSIONS FOR LIFT WELLS  
(p. 218, 219(2))

800	680			630			Rated load (Kg)	
	1.5	1.75	1	1.5	1.75	1		
10	9						8	
1.75	1.5	1.75	1	1.5	1.75	1	Rated speed (m/s)	
1 400	1 400	1 400	1 400	1 400	1 100	1 100		Width (Cw) (mm)
1 350	1 350	1 250	1 250	1 250	1 400	1 400	Depth (Cd) (mm)	
2	2	1 75	1 75	1 75	1 66	1 66	Maximum Area (Ca) (m2)	
2 300	2 300	2 300	2 300	2 300	2 300	2 300	Height (mm)	
1 900	1 900	1 800	1 800	1 800	1 800	1 800	Width (Ww) (mm)	
2 300	2 300	2 100	2 100	2 100	2 100	2 100	Depth (Wd) (mm)	
800	800	800	800	800	800	800	Width (Ew) (mm)	
2 100	2 100	2 100	2 100	2 100	2 100	2 100	Height (Eh) (mm)	
1 800	1 700	1 700	1 700	1 700	1 800	1 700	Pit depth (Ph) (mm)	
4 850	4 650	4 450	4 450	4 650	4 850	4 450	Headroom (Sh) (mm)	
15	15	15	15	15	15	15	Area (Ra) (m2)	
2 500	2 500	2 500	2 500	2 500	2 500	2 500	Width (Rw) (mm)	
3 700	3 700	3 700	3 700	3 700	3 700	3 700	Depth (Rd) (mm)	
2 600	2 600	2 600	2 600	2 600	2 600	2 600	Height (Rh) (mm)	
7 650	7 450	7 250	7 250	7 450	7 650	7 250	Overall headroom (Uh) (mm)	

1000													900												
13													12												
2	1.8	1.75	1.6	1.5	1	2.5	2	1.75	1.5	1	2.5	2	1.75	1.5	1	2.5	2								
1 600	1 600	1 600	1 600	1 600	1 600	1 600	1 600	1 600	1 600	1 600	1 600	1 600	1 600	1 600	1 600	1 600	1 400								
1 400	1 400	1 400	1 400	1 400	1 400	1 350	1 350	1 350	1 350	1 350	1 350	1 350	1 350	1 350	1 350	1 350	1 350								
2.4	2.4	2.4	2.4	2.4	2.4	2.2	2.2	2.2	2.2	2.2	2.2	2.2	2.2	2.2	2.2	2	2								
2 300	2 300	2 300	2 300	2 300	2 300	2 300	2 300	2 300	2 300	2 300	2 300	2 300	2 300	2 300	2 300	2 300	2 300								
2 400	2 400	2 400	2 400	2 400	2 400	2 100	2 100	2 100	2 100	2 100	2 100	2 100	2 100	2 100	2 100	1 900	1 900								
2 300	2 300	2 300	2 300	2 300	2 300	2 100	2 100	2 100	2 100	2 100	2 100	2 100	2 100	2 100	2 100	2 300	2 300								
1 100	1 100	1 100	1 100	1 100	1 100	900	900	900	900	900	900	900	900	900	900	800	800								
2 100	2 100	2 100	2 100	2 100	2 100	2 100	2 100	2 100	2 100	2 100	2 100	2 100	2 100	2 100	2 100	2 100	2 100								
2 800	1 800	1 800	1 800	1 800	1 800	2 800	2 800	1 800	1 700	1 700	2 800	2 800	1 800	1 700	1 700	2 800	2 800								
6 000	4 850	4 850	4 300	4 300	4 300	5 650	5 650	4 850	4 650	4 450	5 650	5 650	4 850	4 650	4 450	5 650	5 650								
20	20	20	20	20	20	15	15	15	15	15	15	15	15	15	15	15	15								
3 200	3 200	3 200	3 200	3 200	3 200	3 200	3 200	2 500	2 500	2 500	3 200	3 200	2 500	2 500	2 500	3 200	3 200								
4 900	4 900	4 900	4 900	4 900	4 900	4 900	4 900	3 700	3 700	3 700	4 900	4 900	3 700	3 700	3 700	4 900	4 900								
3 050	2 700	2 700	2 700	2 700	2 700	2 600	2 600	2 600	2 600	2 600	2 600	2 600	2 600	2 600	2 600	2 600	2 600								
9 400	7 750	7 750	7 200	7 200	7 200	8 450	8 450	7 650	7 450	7 250	8 450	8 450	7 650	7 450	7 250	8 450	8 450								

1350	1250													
18	16													
1.75	1.5	1	3.5	2.5	2	1.8	1.75	1.6	1.5	1	3.5	2.5		
2 000	2 000	2 000	1 950	1 950	1 950	1 950	1 950	1 950	1 950	1 950	1 600	1 600		
1 500	1 500	1 500	1 400	1 400	1 400	1 400	1 400	1 400	1 400	1 400	1 400	1 400		
3.1	3.1	3.1	2.9	2.9	2.9	2.9	2.9	2.9	2.9	2.9	2.4	2.4		
2 300	2 300	2 300	2 300	2 300	2 300	2 300	2 300	2 300	2 300	2 300	2 300	2 300		
2 600	2 600	2 600	2 600	2 600	2 600	2 600	2 600	2 600	2 600	2 600	2 400	2 400		
2 300	2 300	2 300	2 300	2 300	2 300	2 300	2 300	2 300	2 300	2 300	2 300	2 300		
1 100	1 100	1 100	1 100	1 100	1 100	1 100	1 100	1 100	1 100	1 100	1 100	1 100		
2 100	2 100	2 100	2 100	2 100	2 100	2 100	2 100	2 100	2 100	2 100	2 100	2 100		
1 900	1 900	1 900	3 650	2 800	2 800	1 900	1 900	1 900	1 900	1 900	3 650	2 800		
4 850	4 800	4 800	6 300	6 150	6 150	4 850	4 850	4 400	4 400	4 400	6 300	6 000		
22	22	22	22	22	22	22	22	22	22	22	20	20		
3 200	3 200	3 200	3 200	3 200	3 200	3 200	3 200	3 200	3 200	3 200	3 200	3 200		
4 900	4 900	4 900	4 900	4 900	4 900	4 900	4 900	4 900	4 900	4 900	4 900	4 900		
2 800	2 800	2 800	3 350	3 150	3 150	2 800	2 800	2 700	2 700	2 700	3 250	3 050		
7 850	7 800	7 800	10 400	9 500	9 500	7 850	7 850	7 250	7 250	7 250	10 400	9 400		





2.1	75x50	75x50	75x50	100x50	100x50	100x50
2.4	100x50	100x50	100x50	100x50	100x50	100x50
2.7	100x50	100x50	125x50	125x50	125x50	125x50
3.0	100x50	125x50	125x50	125x50	125x50	125x50

TABLE 32—PURLINS AND BATTENS

(p. 239(2))

Clear span (m)	Sections are given (mm)								
	Clear distance apart of purlins (m)								
	0.6	0.9	1.2	1.5	1.8	2.1	2.4	2.7	3.0
0.9	50x40	50x40 50x50	50x40 75x40	75x25 75x40	75x40 5x50	75x40 75x50	75x40 75x50	75x50	75x50
1.2	50x40 50x50	75x25 75x40	75x40 75x50	75x40 75x50	75x50	100x40 100x40	100x50	100x50	100x50
1.5	75x25 75x40	75x40 75x100	75x50	100x40 100x50	100x50	100x50 100x75	100x50 100x75	125x50 100x75	125x50 100x75
1.8	75x40 75x50	75x50	100x50	100x50 100x50	125x50 125x75	125x50 25x75	150x50 125x75	150x50 150x75	150x50 150x75
2.1	75x50	100x50	125x50 100x50	125x50 125x75	125x50 125x75	150x50 125x75	150x50 150x75	175x50 150x75	200x50 50x75
2.4	100x50	100x50 100x75	125x50 125x75	150x50 125x75	150x50 150x75	175x50 150x75	175x50 150x75	200x50 150x75	200x50 150x75
3.0	125x50 100x75	150x50 125x75	150x50 125x75	175x50 150x75	200x50 150x75	200x50 200x75	200x50 200x75	200x75 200x100	200x75 200x100

TABLE 33—CEILING JOISTS

(p. 239(3))

Sections in (mm)	Clear spans for various sections at different centres (mm)				
	Mm	Mm	Mm	Mm	Mm
			Celotex or similar ceiling		
	450	600	750	1000	1200
			Plaster Ceiling		
	300	400	450	500	600
	M	M	M	M	m
75 x 50	1.90	1.80	1.70	1.60	1.40
100 x 50	2.40	2.30	2.20	2.10	2.00
125 x 50	3.00	2.90	2.80	2.60	2.40
150 x 50	3.60	3.50	3.30	3.20	2.90
180 x 50	4.20	4.10	3.90	3.70	3.40
205 X 50	4.90	4.70	4.40	4.20	3.80
230 X 50	5.50	5.30	5.20	4.80	4.30

TABLE 34—PROVISION FOR SANITARY FIXTURES AND FITTINGS  
(p. 246(1), 258(8), 261(3)(5))

<i>Type of occupancy and occupancy</i>	<i>Fixture</i>	<i>Exceptions</i>
A1:		<p>(a) any building where facilities with Table 33B are available to both the public or visitors, no separate facilities shall be required for the public or visitors,</p> <p>(b) No separate facilities for the public or visitor shall be required within any shop having a floor area of less than 50m<sup>2</sup>.</p> <p>(c) In any group of shops under one ownership or in any shopping complex on a single construction site-</p> <p>(i) facilities for personnel may be situated at convenient locations and not necessarily in any particular shop or shops;</p> <p>(ii) facilities for the public and visitors may be situated at convenient locations and not necessarily in any particular shop or shops;</p> <p>(iii) facilities for personnel may be grouped or combined with those provided for the use of the public or visitors.</p> <p>(d) In any occupancy where personnel are exposed to high-risk substance, dirt, filth, dust, soot, oil, grease or any similar substance, exposure to which is such that showers are necessary, at least a shower per 15 persons shall be provided separately for each sex and such showers shall be located in, or have direct access to, a change room.</p>
Personnel	Table 36	
Public and visitors	Males:	
	1 water closet pan	
	1 wash hand basin	
	Females:	
	1 water closet pan	
	1 wash hand basin	
A2:		
Personnel	Table 36	
Public and visitors	Table 37 (part a)	
Peak demand	Table 37 (part b)	
No peak demand or Participants in sports	Table 36	
A3:	Table 36	
A4:		
Personnel	Table 36	
Public and visitors	Males:	
	1 WC pan	
	1 wash hand basin	
	Females:	
	1 water closet	
	1 wash hand basin	
A5:		
Public and visitors	Table 37 (part a)	
Peak demand	Table 37 (part a)	
No peak demand	Table 37 (part b)	
Participants in sport	Table 36	
B1, B2 and B3	Table 36	
Personnel	1 water closet pan	
Public and visitors	1 wash hand basin	
C1 and C2		
Personnel	Table 36	
Public and visitors	Males	
	1 water closet pan	
	1 wash hand basin	
	Females	
	1 water closet pan	
	1 wash hand basin	

D1, D2 and D3 Personnel Public and visitors D4		
F1, F2 and F3 Personnel	Table 36	Any single hotel or suite or any servant's room with its own facilities need not be provided with separate facilities for males and females Showers may be substituted for baths in the following maximum ratios— Males - two-thirds of total Females - one-third of total
Public and visitors	Males	
	1 water closet pan	
	1 wash hand basin	
	Females	
	1 water closet pan	
	1 wash hand basin	
G1 Personnel	Table 36	
Public and visitors	Males	
	1 water closet pan	
	1 wash hand basin	
	Females	
	1 water closet pan	
	1 wash hand basin	
H1 Personnel	Table 36	
Public, visitors and residents	Males	
	1 water closet pan	
	1 wash hand basin	
	Females	
	1 water closet pan	
	1 wash hand basin	
H2	Table 35	
H3 and H4 Within each dwelling unit	1 water closet pan 1 wash hand basin	
J1, J2, J3 and J4	Table 36	
Educational Institutions Classrooms and lecture rooms		In primary schools the indicated number of sanitary facilities shall in each case be increased by one Separate facilities for personnel and students or pupils shall not be required where all facilities are available to both groups. Separate facilities for residential accommodation and classrooms or lecture rooms shall not be required where facilities in one are easily available to the other.
A3	Table 36	
Personnel Students or Pupils Dormitories or other residential accommodation	Table 37	
H2 Personnel Students or pupils	Table 35	
E1, E2 and E3	Table 36	

TABLE 35—NUMBER OF SANITARY FIXTURES TO BE INSTALLED RELATIVE TO THE OCCUPANCY

(p. 246(1), 261(3)(5))

<i>For an occupancy of up to</i>	<i>Males</i>				<i>Females</i>		
	<i>Water closet pans</i>	<i>Urinals</i>	<i>Wash Hand Basins</i>	<i>Baths</i>	<i>Water Closet pans</i>	<i>Wash Hand Basins</i>	<i>Baths</i>
8	1	1	1	1	2	1	
20	1	2	2	2	3	2	2
40	2	3	3	3	4	3	3
60	3	4	4	4	6	4	4
80	4	6	5	5	9	5	5
100	4	8	6	6	12	6	6
120	5	9	6	6	14	7	7
140	5	10	7	7	15	8	8
180	5	11	8	8	16	8	8
	For an occupancy in excess of 180, add 1 water closet pan for every 50 persons	For an occupancy in excess of 180, add 1 urinal for every 40 persons	For an occupancy in excess of 180 add 1 wash hand basin and 1 bath for every 50 persons		For an occupancy in excess of 180 add 1 Water closet pan, 1 wash hand basin and 1 bath for every 60 persons		

TABLE 36—NUMBER OF SANITARY FIXTURES TO BE INSTALLED RELATIVE TO OCCUPANCY

(p. 246(1), 261(3)(5))

<i>For an occupancy of up to</i>	<i>Males</i>			<i>Females</i>	
	<i>Water closet pans</i>	<i>Urinals</i>	<i>Wash Hand Basins</i>	<i>Water closet pans</i>	<i>Wash Hand Basins</i>
15	1	1	1	2	1
30	1	2	2	3	2
60	2	3	3	5	3
90	3	5	4	7	4
120	3	6	5	9	5
	For an occupancy in excess of 120 add 1 Water closet pan, 1 urinal and 1 wash hand basin for every 100 persons			For an occupancy in excess of 120 add 1 water closet pan for every 50 persons	For an occupancy in excess of 120 add a wash hand basin for every 100 persons

TABLE 37—NUMBER OF SANITARY FIXTURES TO BE INSTALLED  
RELATIVE TO THE OCCUPANCY

(p. 246(1), 261(3)(5))

<i>For an occupancy of up to</i>	<i>Males</i>			<i>Females</i>	
	<i>Water closet pans</i>	<i>Urinals</i>	<i>Wash hand basins</i>	<i>Water closet pans</i>	<i>Wash hand basins</i>
<i>(a) Facilities subject to peak demand</i>					
50	1	1	1	2	1
100	1	2	1	3	2
150	1	3	1	5	3
250	2	4	2	7	4
500	3	7	3	12	6
1000	3	12	4	16	7
1500	4	15	5	20	8
	For an occupancy in excess of 1,500 add 1 Water closet pan for every 500 persons	For an occupancy in excess of 1,500 add 1 urinal for every 300 persons	For an occupancy in excess of 1,500 add 1 Wash hand basin for every 500 persons	For an occupancy in excess of 1,500 add 1 water closet pan for every 150 persons	For an occupancy in excess of 1,500 add 1 wash hand basin for every 500 persons
<i>(b) Facilities not subject to peak demand</i>					
50	1	-	1	1	1
100	1	1	1	2	1
150	1	2	1	3	2
250	2	3	2	5	3
500	2	4	3	6	4
1000	2	6	5	8	6
1500	3	7	6	10	7
	For an occupancy in excess of 1,500 add 1 water closet pan for every 1,000 persons	For an occupancy in excess of 1,500 add 1 urinal for every 500 persons	For an occupancy in excess of 1,500 add 1 wash handbasin for every 700 persons	For an occupancy in excess of 1,500 add 1 water closet pan for every 300 persons	For an occupancy in excess of 1,500 add 1 wash hand basin for every 700 persons

TABLE 38—NUMBER OF SANITARY FIXTURES TO BE INSTALLED RELATIVE TO THE OCCUPANCY

(p. 246(1), 261(3)(5))

<i>For an occupancy of up to</i>	<i>Males</i>			<i>Females</i>	
	<i>Water closet pans</i>	<i>Urinals</i>	<i>Wash hand basins</i>	<i>Water closet pans</i>	<i>Wash hand basins</i>
<i>(a) Facilities subject to peak demand</i>					
50	1	1	1	2	1
100	1	2	1	3	2
150	1	3	1	5	3
250	2	4	2	7	4
500	3	7	3	12	6
1000	3	12	4	16	7
1500	4	15	5	20	8
	For an occupancy in excess of 1,500 add 1 water closet pan for every 500 Persons	For an occupancy in excess of 1,500 add 1 urinal for every 300 Persons	For an occupancy in excess of 1,500 add 1 Wash hand basin for every 500 persons	For an occupancy in excess of 1,500 add 1 water closet pan for every 150 Persons	For an occupancy in excess of 1,500 add 1 wash hand basin for every 500 Persons
<i>(b) Facilities not subject to peak demand</i>					
50	1	—	1	1	1
100	1	1	1	2	1
150	1	2	1	3	2
250	2	3	2	5	3
500	2	4	3	6	4
1000	2	6	5	8	6
1500	3	7	6	10	7
	For an occupancy in excess of 1,500 add 1 water closet pan for every 1,000 persons	For an occupancy in excess of 1,500 add 1 urinal for every 500 persons	For an occupancy in excess of 1,500 add 1 wash hand basin for every 700 persons	For an occupancy in excess of 1,500 add 1 water closet pan for every 300 persons	For an occupancy in excess of 1,500 add 1 wash hand basin for every 700 Persons

TABLE 39—MAXIMUM PERMISSIBLE DRAIN LOADS  
(p. 246(1), 265, 273(4))

<i>Maximum Load (Fixture Units)</i>													
<i>Nominal pipe diameter (mm)</i>	<i>Drain having a gradient of</i>												
	1 in 5	1 in 10	1 in 20	1 in 40	1 in 60	1 in 80	1 in 100	1 in 120	1 in 150	1 in 200	1 in 300	1 in 400	1 in 500
100	12 000	9 000	6 400	4 500	3 650	3 150 (sp)	2 800 (sp)	2 550 (sp)	np	np	Np	np	np
(110 OD)													
150	40 000	27 000	19 000	13 500	11 000	7 500	8 400	7 700	6 900	6 000	Np	np	np
(160 OD)													
200	75 000	56 000	40 000	28 500	23 000	20 000	18 000	16 500	15 000	13 000	10 600	np	np
225	105 000	76 000	54 000	38 000	31 000	27 000	24 000	22 000	19 500	17 000	14 000	np	np
250	100 000	72 000	51 000	41 000	36 000	32 000	29 000	26 000	22 500	15 500	16 000	np	
300	—	165 000	117 000	82 000	67 000	58 000	52 000	47 500	42 500	37 000	30 000	26 000	23 500
375	—	295 000	210 000	148 000	125 000	104 000	93 000	85 000	76 000	66 000	54 000	47 000	42 000



TABLE 40—SEWAGE FLOW FROM BUILDINGS  
(p. 258(5)(6))

Type of establishment	Sewage flow (litres per person per day)
Boarding houses	110
Additional kitchen wastes for non-resident boarders	23
Hotels without private baths	110
Hotels with private baths	140
Restaurants (toilet & kitchen wastes per patron)	20
Tourist camps or caravan parks with central bathhouse	90
Day schools	37
Day workers at offices per shift	90
Hospitals	500
Factories (litres per person per shift, exclusive of industrial wastes)	140
Swimming baths Motels (per bed)	90
Drive-in theatres (per car space)	9
Residential dwelling units	150

TABLE 41—RATES OF PERCOLATION AND EFFLUENT

(p. 258(9))

Percolation rate: Average time for 25mm fall of test water level, minutes	Rate of application of effluent to subsoil infiltration areas, litres per sq. of french drain wall area per day
0-3	108 max.
3-5	108-100
6-10	99-80
11-15	79-65
16-20	64-53
21-26	52-40
27-30	39-33
Over 30	Not permitted

TABLE 42—FIXTURE UNIT RATINGS OF SANITARY FIXTURES

(p. 262(3))

Examples of Sanitary fixtures	Nominal diameter of trap, mm	Hydraulic load, fixture units
Wash hand basin, bidet, wall-mounted urinal (separate trap)	32	1
Bath, sink, shower, wash trough	40	2
Wall-mounted urinal with integral trap, commercial electrical sanitary fixtures	50	3
	75 or 80	5
WC pan	100	8
Sanitary group		12
<p>Notes</p> <p>The fixture unit rating for each type of fixture is a – measure of the hydraulic load and takes into account the duration of discharge, the interval between discharges and the mean discharge rate of the particular fixture.</p> <p>The hydraulic load for a sanitary group is not the same as the sum of the hydraulic loads for the individual fixtures comprising such group because the assumption made regarding the interval between discharges is different in each case.</p>		

TABLE 43—DISCHARGE STACK AND SUPPLEMENTARY  
VENT STACK SIZES FOR SINGLE STACK SYSTEMS FOR  
RESIDENTIAL OCCUPANCY  
(p. 263(2))

Number of storeys served by discharge stack	Nominal diameter of discharge stack (mm)	Minimum nominal diameter of supplementary vent stack for discharge stack serving one or two sanitary groups in each storey, with cross vent at each floor (mm)
Up to 10	100	Vent stack not required
11 to 15	100	50
	150	Vent stack not required
16 to 30	150	Vent stack not required

TABLE 44—DISCHARGE STACK AND SUPPLEMENTARY –  
VENT STACK SIZES FOR SINGLE STACK SYSTEMS:  
OFFICE OCCUPANCY  
(p. 263(3))

Number of storeys served by discharge stack	Maximum number of sanitary fixtures in a range in each storey	Minimum nominal diameter of discharge stack, mm	Minimum nominal diameter of supplementary vent stack, mm
1 -4	Not exceeding 5 water closet pans and 5 wash hand basins	100	Vent stack not required
5-8	Not exceeding 2 water closet pans and 2 wash hand basins		
	3 water closet pans and 3 wash hand basins		32
	Exceeding 3 water closet pans and 3 wash hand basins but not exceeding 5 water closet pans and 5 wash hand basins		40
9-12	Not exceeding 2 water closet and 2 wash hand basins		32
	Exceeding 2 water closet pans and 2 wash hand basins but not exceeding 4 water closet pans and 4 wash hand basins		40

1 -8	Not exceeding 5 water closet pans and 5 wash hand basins	150	Vent stack not required
9-24	Exceeding 3 water closet pans and 3 wash hand basins, but not exceeding 5 water closet pans and 5 wash hand basins		75

TABLE 45—SIZE OF VENTILATING PIPES  
(p. 266(6), 267(b))

Maximum number of fixture units served by vent	Minimum nominal diameter of ventilating pipe, mm											
	32	40 (OD)	40	50 (OD)	50	65	75 (OD)	75	100 (OD)	125	160 (OD)	200
	Maximum developed length of ventilating pipe (mm)											
6		*										
16		9	30	51								
48			9	30	51							
84			9	21	51	75						
128			7	15	36	60	90					
190			5	7	27	51	75					
1 000					7	18	24	96				
2 200					5	9	15	57	177			
3 800						5	7	27	75	195		
7 200								7	21	57	222	

TABLE 46—LIMITING GRADIENTS OF DISCHARGE PIPES  
(p. 268(1))

Waste branches				Soil branches				Horizontal pipes other than branch discharge pipes	
Single stack system		Ventilated one-pipe or two-pipe system		Water closet pan		Other soil fixtures		All systems	
Min.	Max.*	Min.	Max.	Min.	Max.	Min.	Max.	Min.	Max.
1.25°	5°	1.25°	5°	5°	14°	2.5°	5°	2.5°	4.5°
(1/46)	(1/11.5)	(1/46)	(1/11.5)	(1/11.5)	(1/4)	(1/23)	(1/11.5)	(1/23)	d/1)
16		9	30	51					

TABLE 47—MINIMUM DIAMETER AND WATER SEAL  
DEPTH OF TRAP

(p. 271(4))

Type of trap	Type of sanitary fixture	Type of Installation	Minimum nominal diameter (mm)	Minimum depth of water seal ( mm)
Integral	water closet pan, hospital soil fixture wall	All	75	50
	Mounted urinal		50	50
Non-integral	Bidet, drinking fountain, wash hand basin, wall-mounted urinal	two-pipe system	32	40
		one-pipe system	32	40
		single stack system	32	75
	Bath, shower, sink (hospital, kitchen or laboratory type), laundry trough, clothes-washing machine, food- waste	two-pipe system	40	40
	Disposal unit (all of the domestic type), sanitary-towel disposer			
		One-pipe system	65	65
		single stack system	40	75
	Clothes-washing machine, dish	All	50	75
	Washing machine, food-waste disposal unit, floor drain (all of commercial type)			
	Urinal of slab or	All	50	50
	Stall type up to 3 units or 1.8M in			
	Length			
	Urinal of slab or			
	Stall type (all other), gully	All	75	50

TABLE 48—SEWERAGE AND WASTE DISPOSAL  
(p. 307(1)(3))

Fittings	Permeable Soils	Impermeable Soils
Sink waste, water closets & servant quarters waste, Baths, lavatory basins and showers	Septic tank, or soak pit, or radial arms or french drains As indicated in paragraph 367 but a separate waste water storage tank	Conservancy tank As indicated in paragraph 367 but a separate waste water storage may be permitted with an approved overflow into the main system of disposal. Tank may be permitted with an approved overflow into the main system of disposal
All waste water from residential, hospital, hotels,	Membrane Bio Reactor, Moving Bed Bio Reactor, Sequencing Batch Reactor, other mechanized Waste Water Treatment Plants that shall ensure that effluent is compliant with the Water Quality Regulations of 2006 (L. N. No. 121 of 2006)	Water shall be recycled and used for irrigating gardens, outdoor cleaning etc. And other non-potable water use

TABLE 49—TREES OR SHRUB SETBACKS  
(p. 331(1))

Trees shall be setback a minimum distance, measured from the centre of the tree trunk, from above and below grade utilities and property lines as follows—

Tree Setbacks from Utilities and Property Lines	
Distance from Power Infrastructure	3.5m
Distance from Fire Hydrants	3.5m
Distance from Stop Signs	3.5m
Distance from Yield Signs	3.5m
Distance from Transit Zones	3.5m*
Distance from Other Signs	2.0m
Distance from Private Property on Walkway	1.0m
Distance from Private Property on Open Parkland	3.0m
Distance from Private Property on Boulevards	1.0m
Distance from Shallow Underground Utilities	1.0m
Distance from Gas or Oil Right of Way	As per the utility company standards

Distance from Deep Underground Utilities	1.5m
Distance from Sanitary and Storm Sewers	1.8m
Distance to Sanitary and Storm Sewers and Manholes	2.0m
Distance from Water Mains	2.5m
*Ensure trees do not create sightline obstructions for vehicles approaching transit zones.	
Note: Distances from overhead power lines shall be as per the requirements established by the Utility Company.	

TABLE 50—TREE SETBACKS FROM WALKWAYS AND ROADS

(p. 331(1))

Trees shall be setback a minimum distance, measured from centre of the tree trunk, to walkway and roads, as follows—

Local Residential	
Face of Curb	1.25m
Face of Curb (Boulevard Without Sidewalk)	2.0m
Collector Residential or Local Industrial (Roadway Width less than 15m)	
20m Right of Way	
Face of Curb	1.25m
Right of Way greater than 20m	
Face of Curb	1.65m
15m Industrial or Local Collector	
Face of Curb	1.65m
Arterial Roadway	
Face of Curb	2.0m*
Hard surface	
Edge of Commercial or Industrial Accesses	1.5m
Edge of Residential Driveways	1.0m
Edge of Sidewalk	1.0m
* Distances less than indicated above, are at the discretion of the relevant approving authority in consultation with the responsible Road Agency.	
Note: Setback distances apply to both Boulevards and Medians.	

TABLE 51—NATURALIZATION PLANTING

(p. 331(1))

Where naturalization planting is in use, plant material may be substituted as per the following—

Full Size Tree	Potted Tree	Potted Tree	Shrubs	Trees or Shrubs - Whips & Plugs
60mm Calliper.	40mm Calliper.	20mm Calliper.	5 Gallon Pot	Minimum 100mm Pot
<p>A maximum of 10% of the required 60mm calliper trees on a construction site may be substituted for smaller material.</p> <p>Emergent material does not qualify into the shrub or tree equivalency.</p> <p>Shrub size requirement may be substituted at a rate of 5 shrub plugs for 1 full size shrub.</p> <p>Example: One 60mm calliper full size tree can be substituted with either two 40mm calliper potted trees, or five 20mm calliper potted trees or twenty-five 100mm pots (tree or shrubs, whips and plugs).</p>				

TABLE 52—MINIMUM FLOOR SPACE FOR STORAGE CHAMBERS

(p. 348(1))

Description of building	Total floor area as shown on plan	Description of storage chamber	Minimum floor space of storage chamber
Domestic Building	Usable floor space 1,320m <sup>2</sup> or more but not exceeding 13,200 m <sup>2</sup>	Storage chamber	Total usable floor space in m <sup>2</sup> divided by 440
	Usable floor space 13,200 m <sup>2</sup> or more but not exceeding 32000 m <sup>2</sup>	Storage chamber with vehicular access	
Non-domestic Building	Usable floor space 3,960m <sup>2</sup> or more but not exceeding 39,600 m <sup>2</sup>	Storage chamber	Total usable floor space in m <sup>2</sup> divided by 1,320
	Usable floor space 39,600 m <sup>2</sup> or more	Storage chamber with vehicular access	



Composite Building	Aggregate usable floor space 1,320m <sup>2</sup> or more but not exceeding 13,200 m <sup>2</sup>	Storage chamber with vehicular access	Aggregate of the total usable floor space of the domestic building component in m <sup>2</sup> divided by 440 and the total usable floor space of the non-domestic building component in m <sup>2</sup> divided by 1,320.
	Aggregate usable floor space 1,320m <sup>2</sup> or more		

TABLE 53—NON-COMBUSTIBILITY AND FIRE RESISTANCE FOR SMALL HOUSE  
(p. 366(1))

Distance of wall from nearest boundary (m)	Appropriate requirements as to non-combustibility and fire resistance
3	No requirement
1.5 - 3	To be externally non-combustible
1 - 1.5	To be non-combustible throughout
Less than 1	To be non-combustible throughout and to have a resistance to external fire of half-an-hour

TABLE 54—NON-COMBUSTIBILITY AND FIRE RESISTANCE  
(p. 368(1))

Capacity of building (m <sup>3</sup> )	Distance of wall from nearest boundary (m)		Appropriate requirements as to non-combustibility and fire resistance
	Not less than	Less than	
Less than 510	3 and above	- 3 1.5	No requirement. To be externally non-combustible. To be externally non-combustible and to have a fire resistance of 1 hour
510 - 1,020	6 and above	- 6 3	No requirement. To be externally non-combustible. To be externally non-combustible and to have a fire resistance of 1 hour.
1,020 and above	Less than 3		To be externally non-combustible and, unless it is an office building more than 9m from the nearest boundary, to have a fire resistance of 1 hour

TABLE 55—NON-COMBUSTIBILITY AND FIRE RESISTANCE FOR BUILDING OF THE WAREHOUSE CLASS, NOT INTENDED TO BE USED WHOLLY OR PREDOMINANTLY FOR STORAGE  
(p. 368(2))

Capacity of building (m <sup>3</sup> )		Distance of wall from nearest boundary (m)		Appropriate requirements as to non-combustibility and fire resistance
Not less than	Less than	Not less than	Less than	
-	510	3 1.5 1	- 3 1.5	No requirement. To be externally non-combustible. To be externally non-combustible and to have a fire resistance of 1 hour
510	1,020	6 3 1.5	- 6 3	No requirement. To be externally non-combustible. To be externally non-combustible and to have a fire resistance of 1 hour.
1,020	-	3	-	To be externally non-combustible and, unless it is an office building more than 9m. from the nearest boundary, to have a fire resistance of 1 hour

TABLE 56—FIRE RESISTANCE OF FLOORS, COLUMNS, BEAMS AND CERTAIN WALLS  
(p. 373(1))

Class of Building	Height, cubic capacity, floor area (of any one storey)	Fire Resistance
Domestic buildings intended to be used wholly or predominantly for human habitation	Exceeding two storeys but not exceeding 15m. in height, or Exceeding 305 sq. m. but not exceeding 762 sq. m in floor area	30 Min.
	Exceeding 15m. in height, or Exceeding 762 sq. m. in floor area	1 Hour
Domestic buildings not intended to be used wholly or predominantly for human habitation	Exceeding 15m. but not exceeding 22m. in height, or Exceeding 1,416 cu. m. but not exceeding 3,540 cu. m in capacity	30 Min.
	Exceeding 22m. in height, or Exceeding 3,540 cu. m. in capacity	1 Hour
Public buildings and buildings of the warehouse class not used wholly or predominantly for storage	Not exceeding 15m. in height, or Exceeding 1,416 cu. m. but not exceeding 3,540 cu. m. in capacity	20 Min.
	Exceeding 15m. but not exceeding 22m. in height, or Exceeding 3,540 cu. m. but not exceeding 7,079 cu. m. in capacity, and not exceeding 696 sq. m. in floor area	1 Hour

	Exceeding 22m. in height, or Exceeding 7,079 cu. m. in capacity, or c Exceeding 696 sq. m. in floor area	2hrs
Buildings of the warehouse class used wholly or predominantly for storage	Exceeding 2 sq. m. but not exceeding 15m. in height, or Exceeding 708 cu. m. but not exceeding 1,416 cu. m. in capacity	45 Min.
	Exceeding 1,416 cu. m. but not exceeding 3,540 cu. m. in capacity	1 Hour
	Exceeding 15m. but not exceeding 22m. in height, or Exceeding 3,540 cu. m. but not exceeding 7,080 cu. m. in capacity and not exceeding 696 sq. m. in floor area	2hrs
	Exceeding 22m. in height, or Exceeding 7,080 cu. m. in capacity, and the(c) Exceeding 696 sq. m. in floor area	4hrs

TABLE 57—MAXIMUM DIVISION AREA  
(p. 383(1), 392(2))

Occupancy	No fixed automatic fire extinguishment installation (m2)	With fixed automatic fire extinguishment installation (m2)	
		1 storey	two storeys and over
*E1, *E2, 'E3	1250	1 250	1 250
A2, B2, B3, C1, C2, G1	5000	No limit	10 000
A4, A5, D3, J3, J4	No limit	No limit	No limit
All other occupancies	2500	No limit	5 000

TABLE 58—PRESUMED FIRE RESISTANCE OF WALLS AND PARTITIONS  
(p. 384(1), 434(2)(4))

Construction	Minimum thickness (excluding plaster) for period of hours (mm)				
	6hrs	4 hrs	2 hrs	1 hr	1/2 hr
SOLID CONSTRUCTION:					
Stone, bonded and coursed; bricks of clay, concrete or sand lime: No plaster	216	216*	21 6¥	102	102
Concrete blocks: Class 1 Aggregate: No plaster			102	76	64

Plastered at least 13mm thick on each side			102	64	64
Class 2 Aggregate: No plaster				102	76
Plastered at least 13mm thick on each side			102	76	51
Gypsum blocks: No plaster			102	76	52
Plastered at least 13mm thick on each side			76	51	51
Wood wool slabs: Plastered at least 13mm thick on each side.			76	51	51
Reinforced concrete: Aggregate with reinforcement (in 2 layers in walls over 127mm in thickness) in 2 different spaced not further apart than 153mm centres, the volume of which is not less than 0.2% of the volume of the concrete with minimum cover of 25mm	229	178	102	76	7
Plaster board: Supported at top and bottom edges in steel channels and plastered on each side at least 16mm thickness with gypsum plaster				19	
Glass bricks: In panels not exceeding 4sq.m. in area with expansion joints not less than 2.5mm per m width of the panel at each side of the panel, and not less than 2.5mm per m of the height of the panel at the top of the panel				102	
<p>* Where plastered at least 25mm thick on each side with gypsum/vermiculite plaster not leaner than 1:2 and where the wall does not exceed 3 m either in height or length, the thickness for this period may be 102mm.</p> <p>¥ Where plastered at least 13mm thick on each side and where the wall does not exceed 3 m either in. height or length, the thickness for this period may be 102mm.</p>					
<b>HOLLOW BLOCK CONSTRUCTION:</b>	<b>6hrs</b>	<b>4 hrs</b>	<b>2 hrs</b>	<b>1 hr</b>	<b>1/2 hrs</b>
Clay Blocks: Plastered at least 12mm thick on each side and shells not less than 19mm thick: 1 cell in each block and each block not less than 50% solid				102	76
1 cell in each block and each block not less than 30% solid				152	
2 cells in each block and each block not less than 50% solid			216	102	
2 cells in each block and each block not less than 30% solid				152	
<b>CONCRETE BLOCKS:</b>					
Plastered at least 13mm thick on each side and 1 cell in wall thickness: Class 1 Aggregate		222	114	76	64

Class 2 Aggregate				222	76
Gypsum blocks: Not less than 70% solid: No plaster			76	51	51
Class 1 aggregate means formed slag, pumice, blast furnace slag, crushed brick and burnt clay products, including expanded clay, well burned clinker, crushed limestone Class 2 aggregate means flint, gravel, granite and all crushed natural stones other than limestone.					

TABLE 59—PRESUMED FIRE RESISTANCE OF NON-STRUCTURAL HOLLOW AND PARTITIONS  
(p. 384(1), 434(2)(4))

Construction	Minimum thickness (mm) on each face for period of hours				
	4 hrs	2hrs	1 hr	1/2 hr	
<b>STEEL OR TIMBER STUDDING</b>					
Plaster on metal or timber lathing: Portland cement plaster, Portland cement lime plaster or gypsum plaster			19	13	
Plaster board with or without gypsum plaster; 10mm thick plaster board on each side				5(Neat single coat)	
10mm thick perforated plaster board on each side. Two 10mm thick plaster boards on each side			13		
13mm thick plaster board on each side			Nil		
19mm thick plaster board on each side			10	Nil	
<b>HOLLOW BLOCK CONSTRUCTION: -</b>					
Clay Blocks: Plastered at least 12mm thick on each side and shells not less than 19mm thick: 1 cell in each block and each block not less than 50% solid				102	76
1 cell in each block and each block not less than 30% solid				152	
2 cells in each block and each block not less than 50% solid			21 6	102	
2 cells in each block and each block not less than 30% solid				152	
<b>CONCRETE BLOCKS:</b>					
Plastered at least 13mm thick on each side and 1 cell in wall thickness: Class 1 Aggregate		222	11 4	76	64
Class 2 Aggregate				222	76

Gypsum blocks: Not less than 70% solid: No plaster			76	51	51
Class 1 aggregate means formed slag, pumice, blast furnace slag, crushed brick and burnt clay products, including expanded clay, well burned clinker, crushed limestone Class 2 aggregate means flint, gravel, granite and all crushed natural stones other than limestone.					

TABLE 60—PRESUMED FIRE RESISTANCE OF HOLLOW STUD CONSTRUCTION OF STEEL AND TIMBER  
(p. 384(1), 434(2)(4))

CONSTRUCTION WORKS	Minimum thickness (mm) on each face for a period of hours				
	6 hrs	4 hrs	2hrs	1 hr	1/2 hrs
Steel or Timber Studding: -					
Plaster on metal or timber lathing: Portland cement plaster, Portland cement lime plaster or gypsum				19	13
Plaster board with or without gypsum plaster: 10mm thick plaster board on each side					5 (Neat single coat)
10mm thick perforated plaster board on each side				13	
Two 10mm thick plaster boards on each side				Nil	
13mm thick plaster board on each side				10	
19mm thick plaster board on each side				Nil	

TABLE 61—PRESUMED FIRE RESISTANCE OF FLOORS  
(p. 384(1), 434(2)(4))

Construction	Minimum thickness (mm) for period of hours				
	4 hrs	2 hrs	1 hr	1/2 hr	Periods specified for small houses
FILLER JOIST CONSTRUCTION					
thickness of concrete	152	127	76	89	
Concrete cover on bottom of joist.	76	25	13	13	
SOLID REINFORCED CONCRETE CONSTRUCTION					

(Including flat slab construction and floors constructed on pre-cast inverted “U” channel or T-sections, without a ceiling or soffit): Thickness of concrete	152		102	89	
Concrete cover to reinforcement	25	13	13	13	
<b>HOLLOW BLOCK FLOOR CONSTRUCTION</b> (Including floors constructed of precast concrete units of box- section or I - section):					
Aggregate thickness of non-combustible material (excluding ceiling fishes (if any)	127	89	76	63	
Concrete cover to reinforcement	25	13	13	13	
<b>STRUCTURAL TIMBER CONSTRUCTION:</b>					
(a) Plan edge boarding on timber joists not less than 38mm wide with ceiling of:					
(i) Timber lath and plaster- Thickness of plaster					16
(ii) Timber lath and plaster with plaster of minimum thickness of 15mm covered on underside with plaster, board of thickness			13		
(iii) Metal lath and plaster- Thickness of plaster			19		
(iv) 1 layer of plaster-board of thickness					13
(v) 1 layer of plaster-board of minimum thickness of ,10mm finished with gypsum plaster of thickness					13
(vi) 1 layer of plaster-board of minimum thickness of 13mm finished with gypsum plaster of thickness				13	
(vii) Two layers of plaster-board of total thickness of 13mm finished with gypsum plaster of thickness					19
(viii) 1 layer of insulating board of minimum thickness of 13mm finished with gypsum plaster of thickness					13

(ix) Wood-wool slab 25mm thick finished with gypsum plaster of thickness				5	
(b) Tongued and grooved boarding not less than 19mm (nominal) thickness on timber joists not less than 38mm wide with ceiling of:					
(i) Timber lath and plaster- Thickness of plaster.				10	16
(ii) Timber lath and plaster with plaster of minimum thickness of 19mm covered on underside with plaster-board of thickness				5	10
(iii) Metal lath and plaster: - Thickness of plaster				22	
(iv) 1 layer of plaster-board of thickness					
(v) 1 layer of plaster-board of minimum thickness of 13mm finished with gypsum plaster of thickness.				5	
(vi) 2 layers of plaster-board of total thickness					5
(vii) 1 layer of insulating board of minimum thickness of 13mm finished with gypsum plaster of thickness					
(viii) Wood-wool slab 25mm thick finished with gypsum plaster of thickness				16	
(c) Tongued and grooved boarding not less than 25mm (nominal) thickness on timber joists not less than 178mm deep by 51mm wide with ceiling of:					
(i) Timber lath and plaster thickness of plaster				13	10
(ii) Metal lath and plaster thickness of plaster				5	
(iii) 1 layer of plaster-board of thickness				19	
(iv) 1 layer of plaster board of minimum thickness of 10mm finished with gypsum plaster of thickness					



(v) 1 layer of plaster-board of minimum thickness of 13mm finished with gypsum plaster of thickness				13	13
(vi) 2 layers of plaster board of total thickness				5	
(vii) 1 layer of insulating board of thickness				5	
(viii) 1 layer of insulating board of minimum thickness of 13mm finished with gypsum plaster of thickness				5	

TABLE 62—PRESUMED FIRE RESISTANCE OF STEEL COLUMNS AND BEAMS  
(p. 384(1), 434(2)(4))

Construction	Minimum thickness of protection (mm) for period of hours			
	4 hrs	2 hrs	1 hr	1/2 hr
<b>SOLID PROTECTION: Columns: Reinforced concrete.</b>	64	51	25	25
Solid bricks of burnt clay of sand lime Solid blocks reinforced in every horizontal joint	76	51	51	51
(i) Foamed slag or pumice concrete	64	51	51	51
ii) Gypsum blocks	51	51	51	51
<b>Beams: Reinforced concrete</b>	64	51	25	25
<b>HOLLOWED PROTECTION:</b>				
Columns; Solid bricks or burnt clay or sand lime reinforced in every horizontal joint	114	76	51	51
Solid bricks of foamed slag or pumice concrete or gypsum reinforced in every horizontal joint	76	51	51	51
Moulded asbestos bound in position with Ni-chrome wire not less than No. 16 SWG in thickness, the wires to be sunk not less than 3mm deep in the outer surface of the asbestos and the grooves and all joints in the asbestos to be filled with refractory cement.	64	38	25	25
Portland cement plaster or Portland cement-lime plaster on metal lathing				19
Portland cement plaster or Portland cement-lime plaster on metal lathing with reinforcement over rendering coat			25	
Gypsum plaster on metal lathing			22	16
Gypsum plaster on 10mm gypsum plaster boards with No. 16 S.W.G. wire binding at 102mm pitch			13	

2 layers of metal lathing plastered with gypsum plaster on each layer	19			
Precast concrete consisting of 4 volumes of vermiculite to 1 volume of Portland cement, reinforced with expanded metal, wire mesh of with No. 15 S.W.G. wire binding at 102mm pitch			25	
Portland cement plaster or Portland cement-lime plaster on metal lathing				19
Portland cement plaster or Portland cement-lime plaster on metal lathing with reinforcement over the rendering coat				
Gypsum plaster on metal lathing				
Gypsum plaster on 10mm gypsum board supported on wood battens.				
Gypsum plaster on 19mm gypsum, plastered board with No. 16 S.W.G. wire binding at 102mm pitch				
Precast concrete consisting of 4 volumes of vermiculite mesh or with No. 16 S.W.G. wire binding at 102mm pitch		22 13	25 16 25	5(neat single coat)
Notes				
“solid protection” means casing which is bedded close up to the steel without any intervening cavities and with all joints in that casing made full and solid;				
“hollow protection” means that there is a void between the protective material and the steel. All hollow protection to columns shall be effectively sealed at each floor level;				
“reinforcement” where reinforcement is required in this Table, that reinforcement shall consist of steel binding wire not less than No. 13 S.W.G. in thickness, or a steel mesh weighing not less than 544 grammes per sq. m; and				
in concrete protection the spacing of that reinforcement shall not exceed 3048mm in any direction.				

TABLE 63—PRESUMED FIRE RESISTANCE OF REINFORCED CONCRETE COLUMNS AND BEAMS  
(p. 384(1), 434(2)(4))

Construction and materials	Minimum thickness of protection in mm for period of hours			
	4hrs	2hrs	1hrs	½ hrs
Reinforced concrete columns	450	300	203	152
Reinforced concrete columns with light 51mm mesh reinforcement placed centrally in the concrete cover to longitudinal reinforcement.	300	225		
-	Minimum thickness of protection in mm for period of hours			
	4hrs	2hrs	1hrs	½ hrs
Reinforcement concrete beams	64	51	38	25

NOTE— This Table is not to be applied in the case of post or pre-stressed concrete. Special approval of the approving authority will be required in the case of this special form of construction.
--

TABLE 64—FIRE RESISTANCE OF OCCUPANCY AND DIVISION SEPARATING ELEMENTS  
(p. 385(3))

Occupancy	Fire resistance, minutes
All occupancies other than those referred to below	60
B1, C1, D1, E1, E2, E3, F1, F3, J1	120

TABLE 65—STABILITY OF STRUCTURAL ELEMENTS OR COMPONENT  
(p. 386(2)(3)(4), 398(1)(2), 417(1), 423(4))

Type of occupancy	Class of occupancy	Stability, minutes				
		Single Storey Building	Double Storey Building	3 -10 Storey Building	11 storeys Building and over	Basement in Any Building
Entertainment and public						
Assembly	A1, A2,	30	60	120	120	120
Theatrical and indoor sport	A3,	30	60	120	120	120
Places of instruction	A4, A5	30	30	90	120	120
Worship		30	60	90	120	120
Outdoor sport		30	30	60	90	
High risk commercial service						
Moderate risk commercial	B1 B2 B3	60	60	120	180	120
Service		30	60	120	120	120
Low risk commercial service		30	30	90	120	120
Exhibition hall	C1	60	90	120	120	120
Museum	C2	30	60	90	120	120

High risk industrial	D1	60	90	120	180	240
Moderate risk industrial Low risk industrial Plant room	D2 D3 D4	30	60	90	120	180
		30	30	60	120	120
		30	30	60	90	120
Places of detention Hospital	E1 E2	60	60	90	120	120
Other institutional (residential)	E3	60 60	90 60	120 120	180 180	120 120
large shop	F1 F2	60	90	120	180	120
Small shop Wholesalers' store	F3	30	60	120	180	120
		30	90	120	120	120
Offices	G1	30	30	60	120	120
Hotel Dormitory	H1 H2 H3	30	60	90	1 20	120
Domestic residence Detached dwelling house	H4	30	30	90	120	120
		30	30	90	120	120
		30	30	90	N/A	120
High risk storage Moderate	J1 J2 J3 J4	60	90	120	1 80	240
risk storage Low risk storage		30	60	90	120	180
Parking garage		30	30	90	90	120
		30	30	60	90	120

TABLE 66—CLASSES OF FIRE DOORS OR FIRE SHUTTERS  
(p. 389(3), 427(3)(5))

Type of wall	Required minimum fire resistance of wall, minutes	Class of fire door or fire shutter
Occupancy separation	60	A
	120	B
Divisional separation	60	A
	120	D (or 2 C doors with approval)
Emergency route	120	B



Where:

NC = Non-combustible material only.

SP = Protected by a sprinkler system.

USP = Not protected by a sprinkler system

TABLE 68—CLASSIFICATIONS FOR WALL FINISHES

(p. 394(1)(3))

Class of occupancy	Basement of building of any height	Single and double storey buildings		Building exceeding two storeys		Building of any height	
		USP	SP	USP	SP	Feeder routes	Emergency routes
	Any wall area except that contemplated in column 5 or 6						
	SP	USP	SP	USP	SP		
A1	1	3	3	3	3	2	1
A2	1	3	3	3	3	2	1
A3	1	3	3	3	3	2	1
A4	1	4	4	3	4	2	1
B1	2	3	4	3	4	3	1
B2	2	3	4	3	4	3	1
B3	3	4	5	4	5	3	1
C1	3	3	4	3	4	2	1
C3	3	3	4	3	4	2	1
D1	NC	NC	NC	NC	NC	NC	NC
D2	2	3	4	3	4	3	1
D3	2	4	5	4	5	3	1
D4	NC	NC	NC	NC	NC	NC	NC
E1	NC	2	2	2	2	2	1
E2	NC	2	2	2	2	2	1
E3	NC	2	2	2	2	2	1
F1	3	2	3	2	3	2	1
F2	3	2	3	2	3	2	1
F3	3	2	3	2	3	2	1
G1	3	4	5	4	5	3	1
H1	NC	3	5	3	5	3	1
H2	NC	3	4	2	4	3	1
H3	NC	4	5	3	4	3	1
J1	NC	NC	NC	NC	NC	NC	NC
J2	NC	NC	3	NC	3	2	1
J3	2	3	4	2	3	2	1
J4	NC	NC	NC	NC	NC	NC	NC
NC=Non –combustible material only SP=Protected by a sprinkler system USP=Not protected by a sprinkler system							
NOTE: Table refers only to those areas actually used for the occupancies given.							

TABLE 69—MINIMUM NUMBER OF EXIT DOORS PER ROOM POPULATION  
(p. 396(2))

Number of persons	Minimum number of exit doors
50 to 240	2
241 to 500	3
501 to 750	4
751 to 1000	5
Over 1000 person	6

TABLE 70—WIDTH OF FIRE ESCAPE ROUTES  
(p. 399(9), 401(7))

Maximum number of persons	Minimum width (mm)
120	1100
130	1200
140	1300
150	1400
160	1500
170	1600
180	1700
190	1800
200	1900

TABLE 71—COLOUR CODING OF FIRE HYDRANTS BONNETS  
(p. 412(17))

Bonnet Colour	Litres per Minute
Green	greater than 4,000
Orange	2,000 - 4,000
Red	less than 2,000

TABLE 72—PROVISION OF PORTABLE FIRE EXTINGUISHERS  
(p. 414(1)(2), 415(2))

Classification of occupancies	Number of portable fire extinguishers relative to floor area
A1, B1, D1, D2, H2, J1, J2, J3	1 per 100m <sup>2</sup>
A2, A3, A4, B2, C1, C2, D3, E1, E2, E3, F1, F2, F3, G1, H1,	1per 200m <sup>2</sup>
A5, B3 D4, H3, J4	1 per 400m <sup>2</sup>

TABLE 73—CLASSIFICATION OF FINISHING MATERIALS ACCORDING TO  
FIRE INDICES  
(p. 436)

Class	Maximum values			
	Spread of flame index, If	Heat contributed Index, I	Smoke emitted Index, Is	Surface fire Index, F
1	0.1	0.1	0.2	0.1
2	0.7	0.8	1.0	0.6
3	1.5	1.7	2.0	1.2
4	3.5	3.8	4.0	2.9
5	5.5	5.8	6.0	4.5

TABLE 74—CLASSIFICATION OF FLOOR COVERINGS ACCORDING TO FIRE  
INDICES  
(p. 437)

Class	Maximum values			
	Spread of flame index, If	Heat contributed Index, I	Smoke emitted Index, Is	Surface fire Index, F
1	0.2	0.2	0.15	0.1
2	1.0	0.9	0.9	0.7
3	2.1	2.1	2.1	1.7
4	3.9	3.9	3.9	3.3
5	5.0	5.0	5.0	4.5

TABLE 75—MINIMUM WIDTH OF CARRIAGEWAY AND FOOTPATHS-  
INDUSTRIAL AND MIXED-USE AREAS  
(p. 497(2))

Type of road	Width of the Carriageway	Width of Footpath
Major	7.5 m	3.0 m
Minor	7.0 m	2.75 m



TABLE 76—MINIMUM WIDTH OF CARRIAGEWAY AND FOOTPATHS-  
PRIVATE ROADS  
(p. 498(1))

Type of road	Width of the Carriageway	Width of Footpath
Major	7.0 m	2.75m
Minor	5.5m	2.0m

TABLE 77 — WIDENING OF CARRIAGEWAY  
(p. 506)

Width of Carriageway	Permitted radius of curve at centre line	Minimum widening
6.0m or less	Less than 18.0m	1.2m
	18.0 m to 24m inclusive	1.0m
	Over 24.0m	0.6m
More than 6.0m	Less than 18.0m	1.0m
	18.0 m to 24.0m inclusive	0.6m
	Over 24.0m	0.3m

## SECOND SCHEDULE

### FIGURES

FIGURE 1—GARAGE DIMENSIONS  
(p. 37(1))

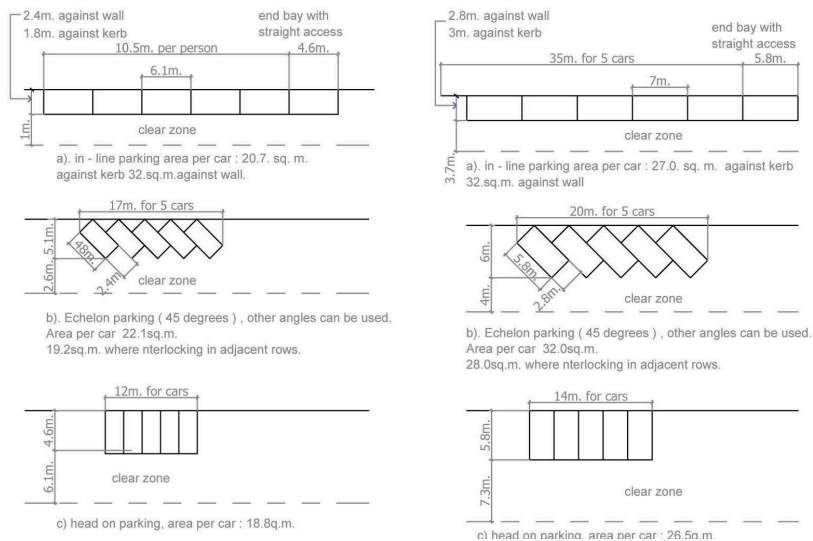

FIGURE 2—MINIMUM DIMENSIONS FOR GARAGES  
(p. 37(2))

Single Parking. Double Parking

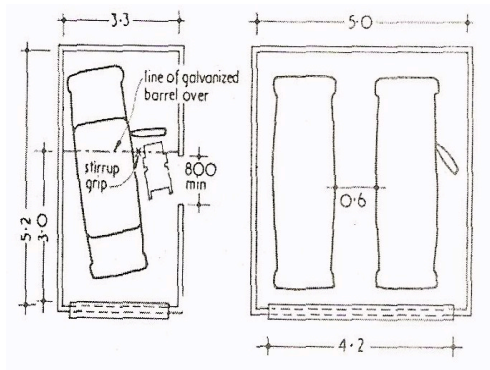
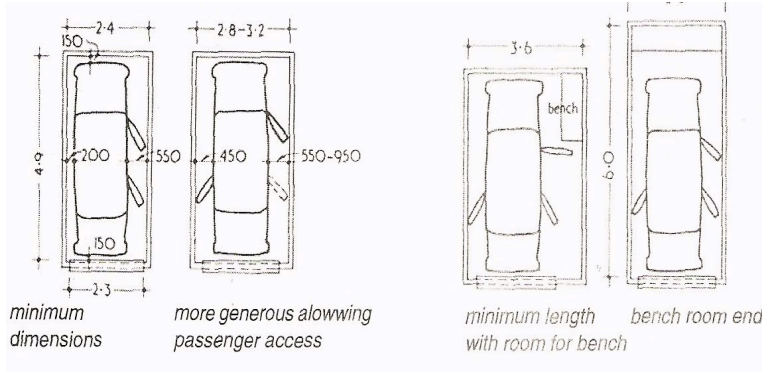
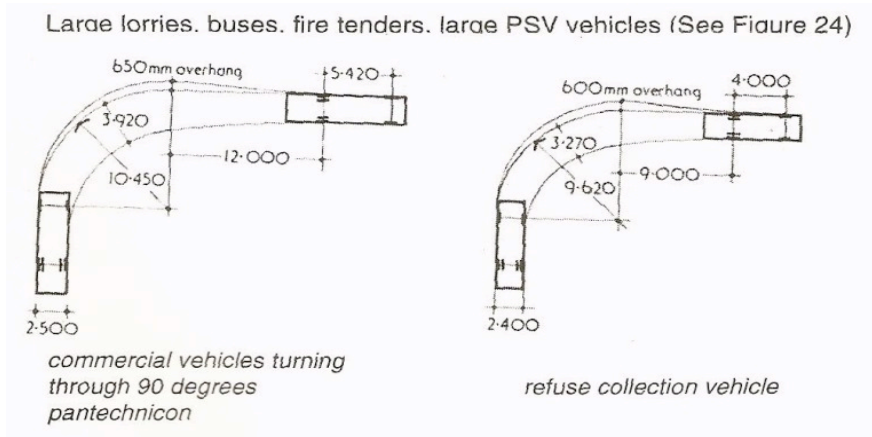

FIGURE 3—TURNING CIRCLES FOR VEHICLES  
(p. 37(3))



External circulation

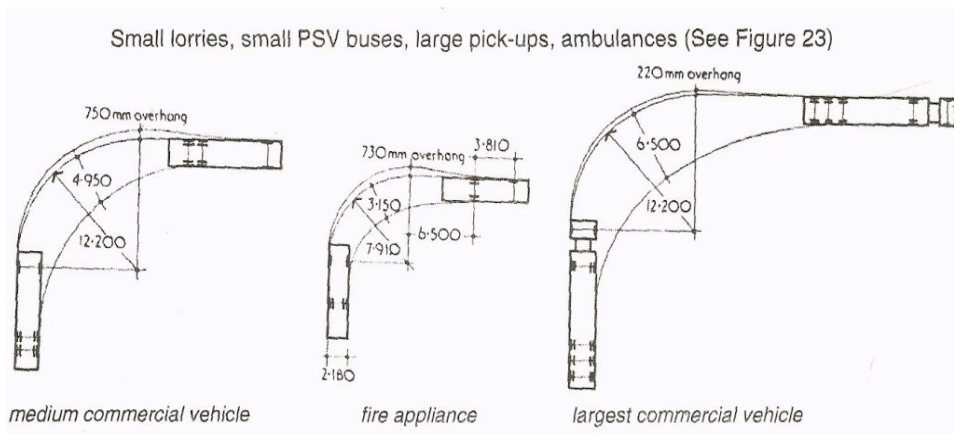
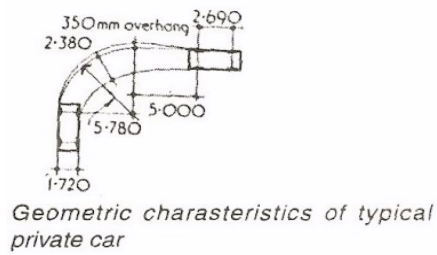
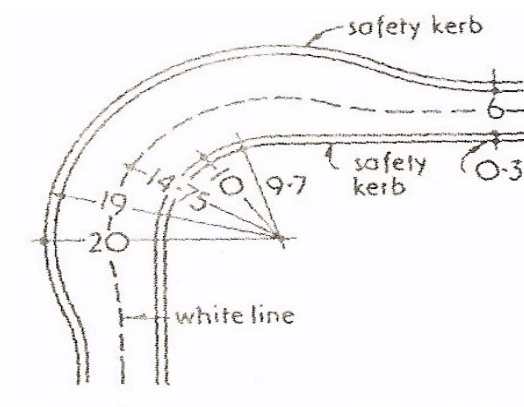
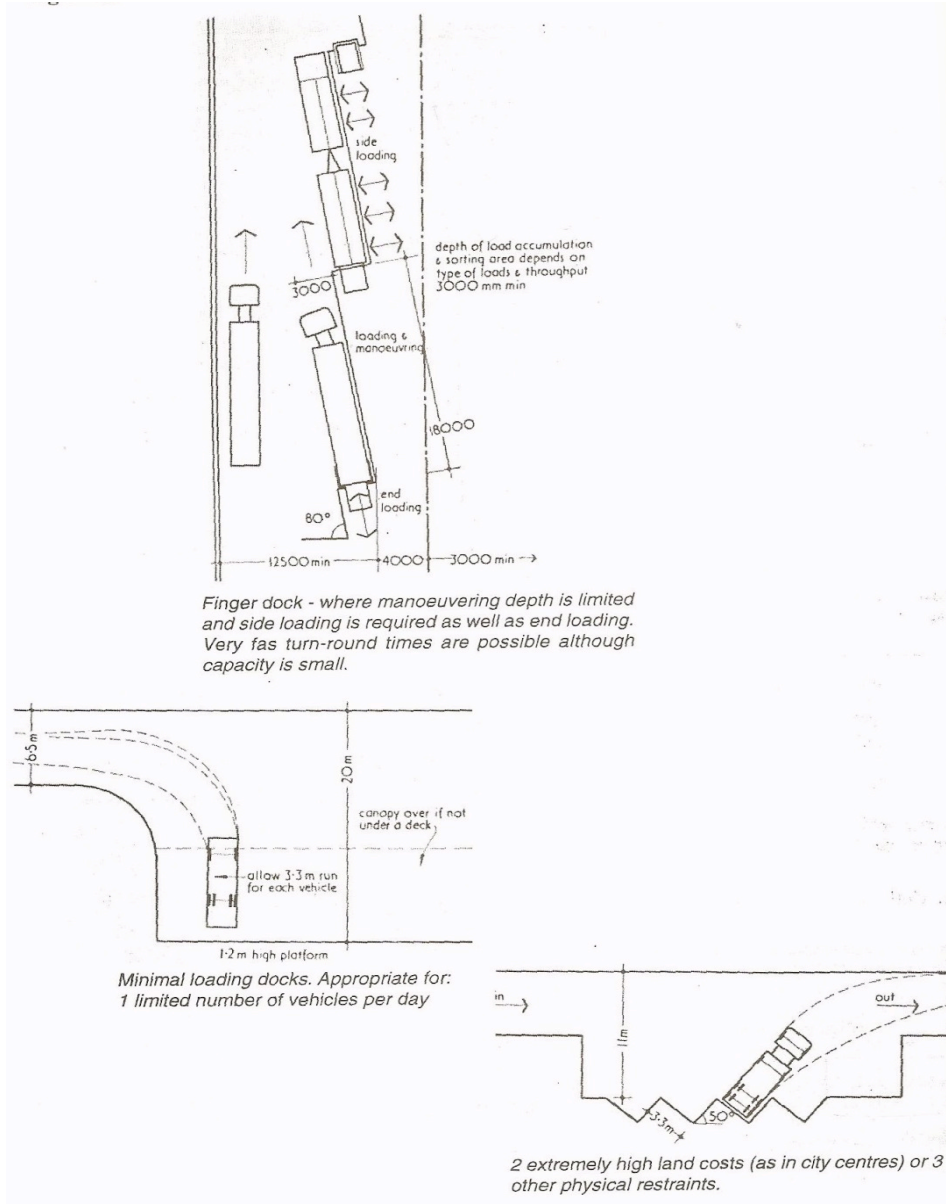

FIGURE 4—GUARDING DESIGN  
(p. 40(2))

Building Category and Location		Strength.	Height.(h)	
Single family dwellings	Stairs , landings , ramps , edges of roof	0.36KN / m.	900mm. for all elements	
	External balconies and edges of roof	0.74KN / m.	1100mm.	
Factories & Ware Houses ( light traffic ).	Stairs , ramps.	0.36KN / m.	900mm.	
	Landings and edges of floor.	0.36KN / m.	1100mm.	
Residential, Institutional, Educational, Office, and Public Buildings	All locations.	0.74KN / m.	900mm. for flights other wise 1100mm.	
Assembly	530mm.in front of fixed seating.	Refer to BS 6399 Part 1.	800mm.(h1)	
	All other locations.		900mm. for flights elsewhere 1100mm.(h2)	
Retail	All locations.	1.5KN / m.	900mm. for flights other wise 1100mm.	
All buildings	At opening windows except roof windows in loft extensions , see approved document B1, Diagramm 4.		800mm.	
	At glazing to changes of level	To Provide containment	below 800mm.	

FIGURE 5—FINGER DOCK FOR LARGE VEHICLES  
(p. 46)





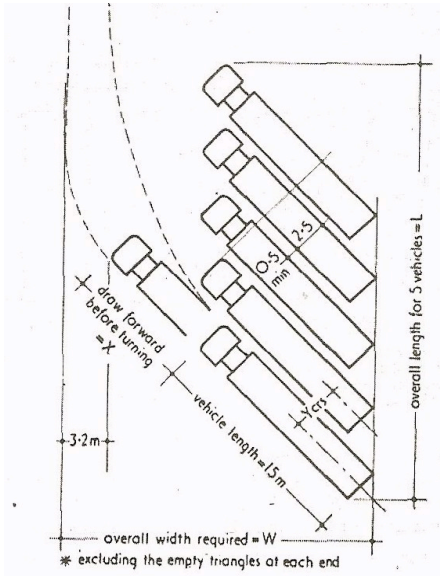

FIGURE 6— MEASUREMENT OF FLOOR PLAN AREA  
(p. 88(3))

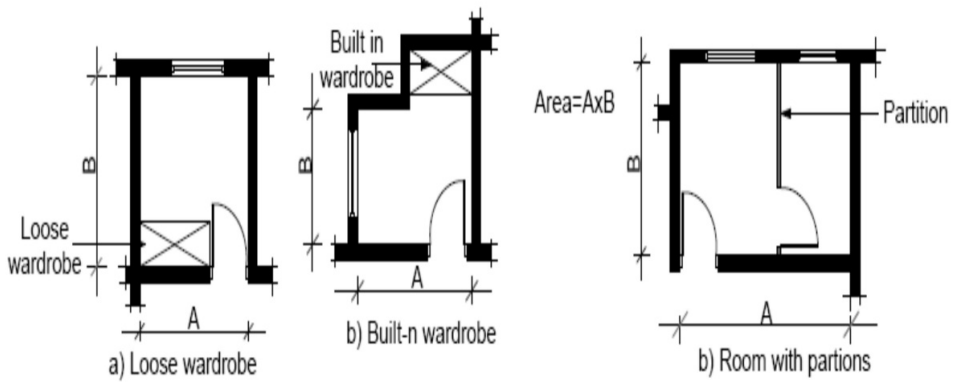

FIGURE 7—ROOM HEIGHT  
(p. 89(1)(3))

MINIMUM FLOOR TO CEILING HEIGHT

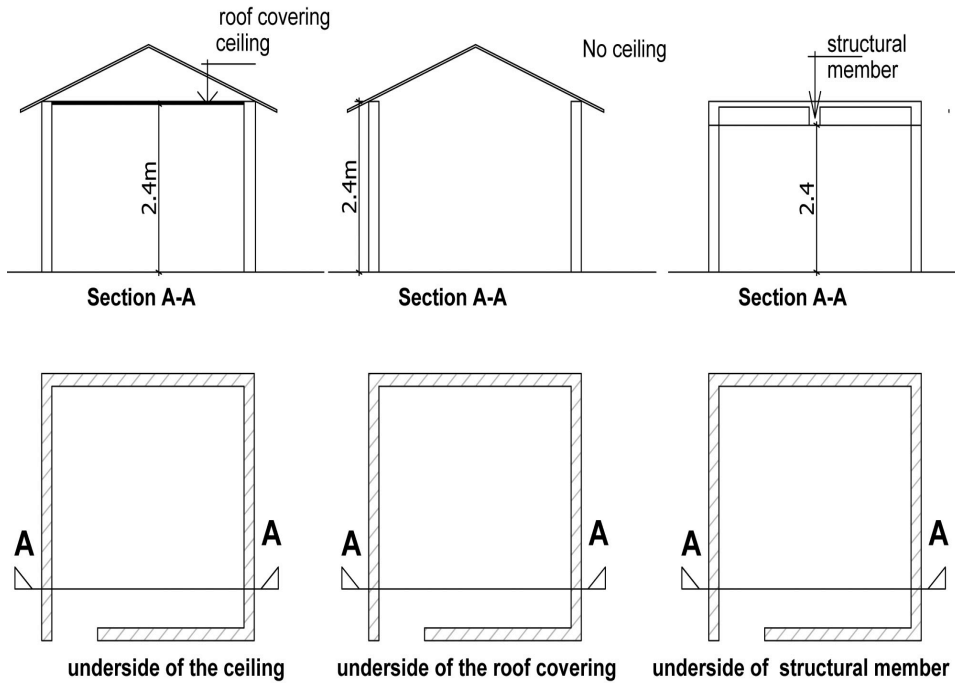

FIGURE 8—ZONE OF SPACE WITH OPENING DIVIDED INTO PORTIONS  
(p.137(2))

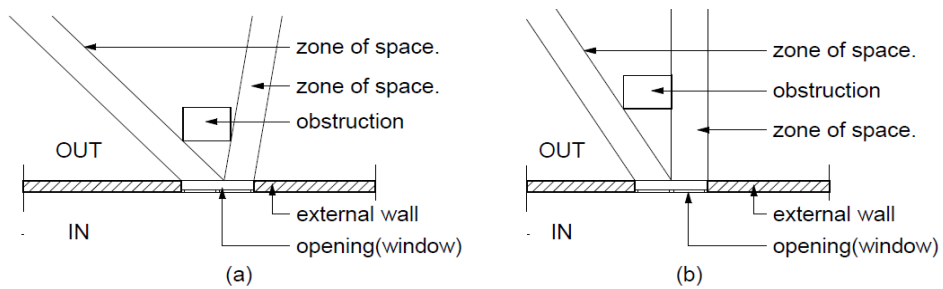
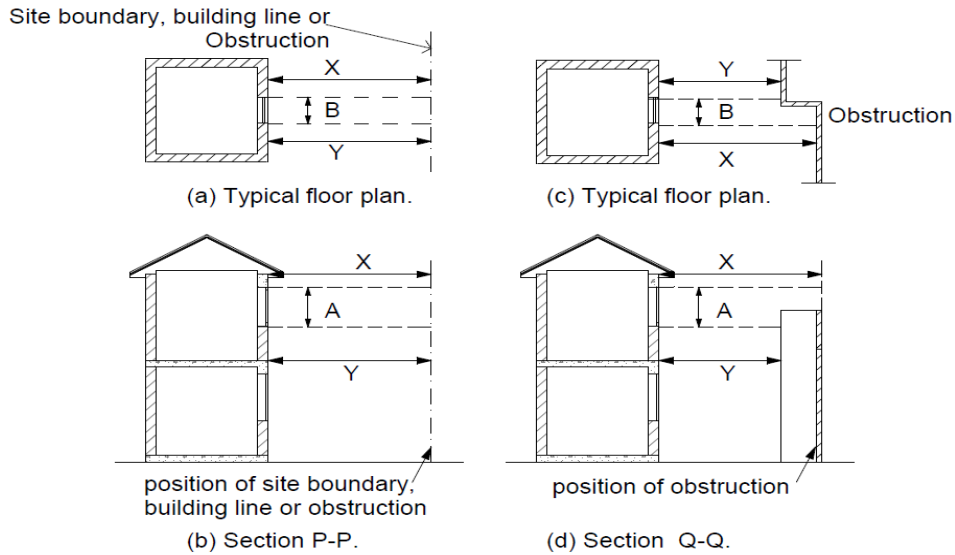

FIGURE 9—LENGTH OF ZONE OF SPACE  
(p. 137(6))



In all cases the length of the zone of space is  $\frac{X+Y}{2}$

FIGURE 10—MINIMUM REQUIREMENTS FOR WINDOW FACING OBSTRUCTION  
(p. 144(1)(c))

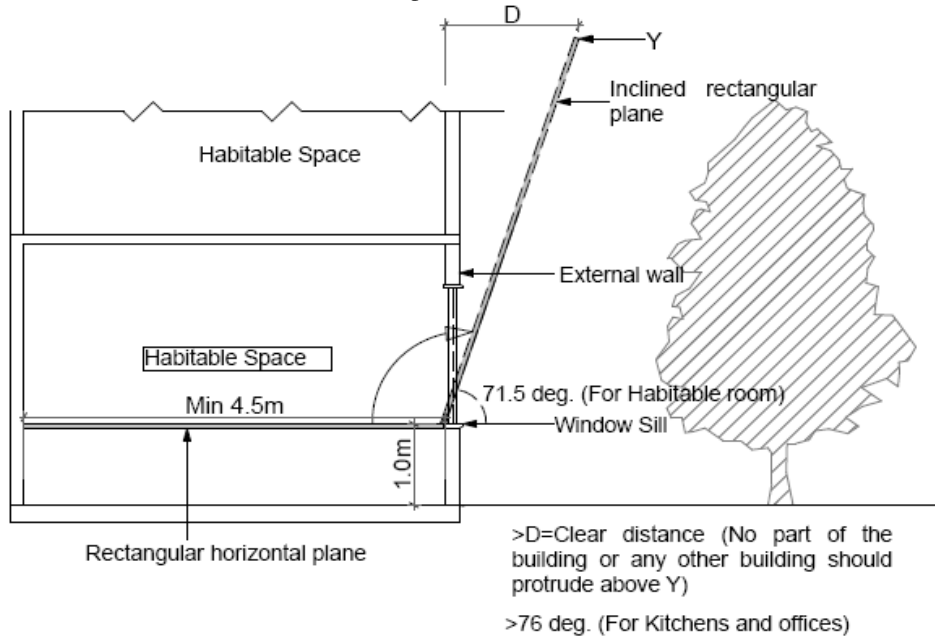



FIGURE 11 – MINIMUM REQUIREMENTS WHERE WINDOW OPENS TO AN AREA BOUNDED ON THE SIDE OPPOSITE THE WINDOW BY A BOUNDARY (p. 166(1))

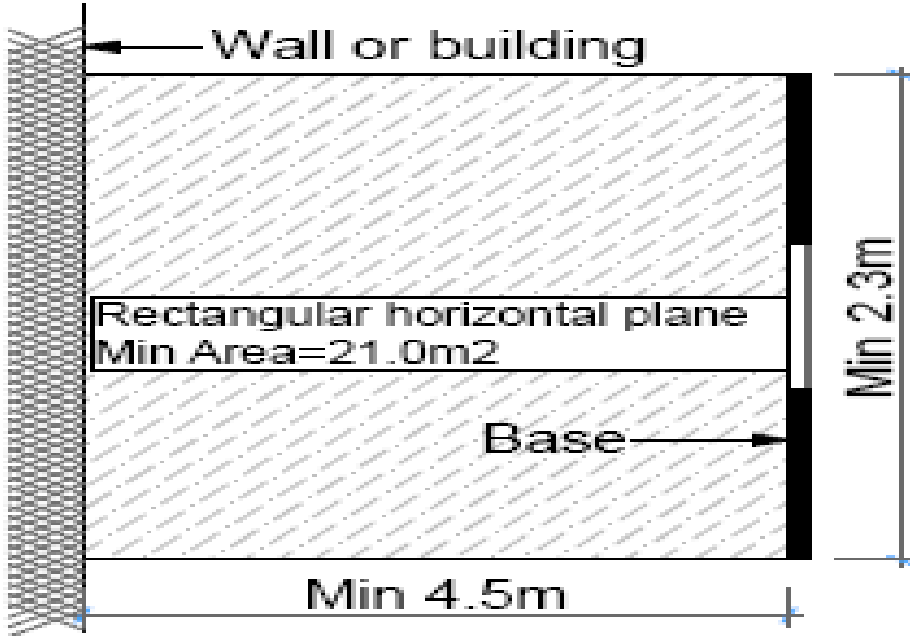
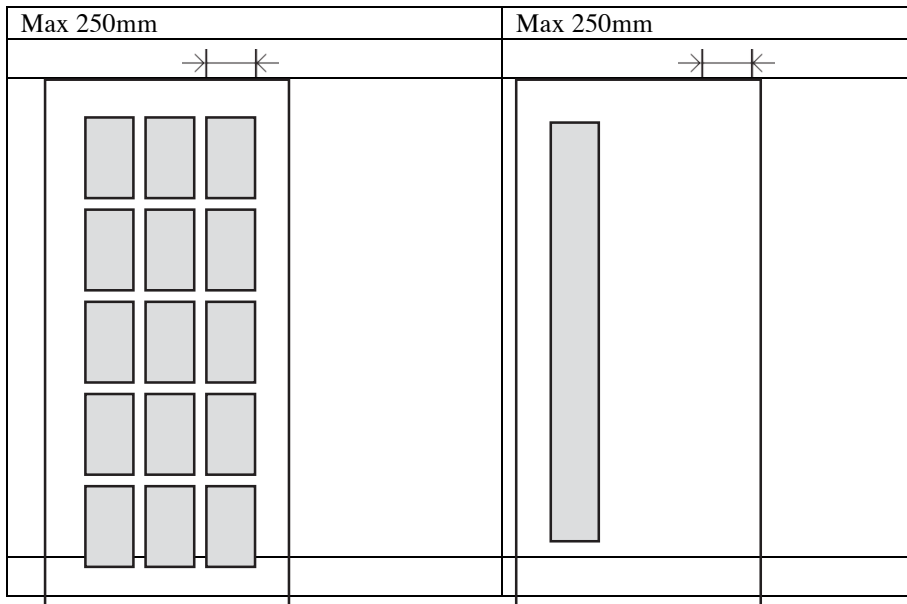
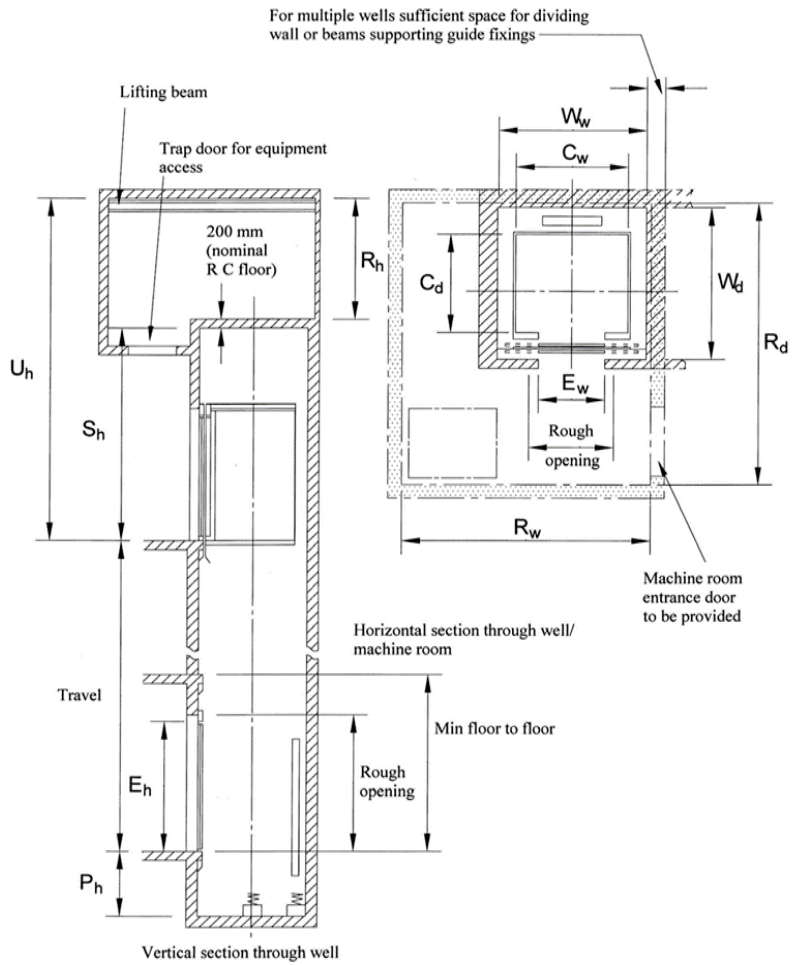

FIGURE 12 – DIMENSIONS AND AREAS OF SMALL PANES (p. 178(4))



Note: Maximum area of single pane not to exceed 0.5m.  
Small panes of annealed glass should not be less than 6mm in thickness

FIGURE 13—LIFT WELL ENCLOSURE DIMENSION  
(p. 219(2))



Made on the 20th December, 2023.

ALICE WAHOME,  
Cabinet Secretary for Lands,  
Public Works, Housing and Urban Development.



Republic of Kenya

**THE NATIONAL**  
**BUILDING CODE**  
**2024**